

SUMMERSTONE
1550P
 LOT 60
 ELEV-B-LEFT

Sheet Index

#	Sheet Name
153.4-TIE	Electrical
154-TIS	Structural Framing
155.1-TIE	Structural Framing
155.4-TIE	Electrical
156.1-TE	Structural Framing
156.2-TE	Sheathing
157.1-TE	Structural Framing
157.2-TE	Sheathing
158.1-TE	Structural Framing
159.1-TE	Structural Framing
159.2-TE	Sheathing
160.1-TE	Structural Framing
160.2-TE	Sheathing
160.4-TE	Electrical

#	Sheet Name
143.1-TE	Structural Framing
143.2-TE	Sheathing
143.4-TE	Electrical
144.1-TE	Structural Framing
144.2-TE	Sheathing
144.4-TE	Electrical
145.1-TE	Structural Framing
145.2-TE	Sheathing
145.4-TE	Electrical
146.1-TE	Structural Framing
146.2-TE	Sheathing
146.4-TE	Electrical
147.1-TE	Structural Framing
147.2-TE	Sheathing
147.4-TE	Electrical
148.1-TE	Structural Framing
148.2-TE	Sheathing
149.1-TE	Structural Framing
149.2-TE	Sheathing
149.4-TE	Electrical
150.1-TE	Structural Framing
150.2-TE	Sheathing
150.4-TE	Electrical
151.1-TIE	Structural Framing
151.4-TIE	Electrical
152.1-TIE	Structural Framing
152.4-TIE	Electrical
153.1-TIE	Structural Framing

#	Sheet Name
125.4-TIE	Electrical
126.1-TIE	Structural Framing
126.4-TIE	Electrical
127.1-TIS	Structural Framing
128.1-TIPE	Structural Framing
128.4-TIPE	Electrical
129.1-TIS	Structural Framing
130.1-TIS	Structural Framing
131.1-TIS	Structural Framing
132.1-TIE	Structural Framing
132.4-TIE	Electrical
133.1-TIS	Structural Framing
133.2-TIS	Sheathing
133.4-TIS	Electrical
134.1-TIE	Structural Framing
134.2-TIE	Sheathing
134.4-TIE	Electrical
135.1-TE	Structural Framing
136.1-TE	Structural Framing
137.1-TE	Structural Framing
137.2-TE	Sheathing
138.1-TE	Structural Framing
139.1-TE	Structural Framing
140.1-TE	Structural Framing
141.1-TE	Structural Framing
142.1-TIPE	Structural Framing
142.3-TIPE	Plumbing
142.4-TIPE	Electrical

#	Sheet Name
112.1-TIE	Structural Framing
112.4-TIE	Electrical
113.1-TIPE	Structural Framing
113.3-TIPE	Plumbing
113.4-TIPE	Electrical
114.1-TIS	Structural Framing
115.1-TIPE	Structural Framing
115.3-TIPE	Plumbing
115.4-TIPE	Electrical
116.1-TIE	Structural Framing
116.4-TIE	Electrical
117.1-TIE	Structural Framing
117.4-TIE	Electrical
118.1-TIS	Structural Framing
119.1-TIS	Structural Framing
120.1-TIE	Structural Framing
120.4-TIE	Electrical
121.1-TE	Structural Framing
121.2-TE	Sheathing
121.4-TE	Electrical
122.1-TIE	Structural Framing
122.4-TIE	Electrical
123.1-TIPE	Structural Framing
123.3-TIPE	Plumbing
123.4-TIPE	Electrical
124.1-TIE	Structural Framing
124.4-TIE	Electrical
125.1-TIE	Structural Framing

#	Sheet Name
01-GEN	Sheet Index
02-GEN	Wall Panel Layout
100.1-TE	Structural Framing
100.2-TE	Sheathing
100.4-TE	Electrical
101.1-TE	Structural Framing
101.2-TE	Sheathing
101.4-TE	Electrical
102.1-TE	Structural Framing
102.2-TE	Sheathing
102.4-TE	Electrical
103.1-TE	Structural Framing
103.2-TE	Sheathing
103.4-TE	Electrical
104.1-TE	Structural Framing
104.2-TE	Sheathing
105.1-TE	Structural Framing
105.2-TE	Sheathing
106.1-TIE	Structural Framing
106.4-TIE	Electrical
107.1-TIPE	Structural Framing
107.4-TIPE	Electrical
108.1-TIE	Structural Framing
108.4-TIE	Electrical
109.1-TIE	Structural Framing
109.4-TIE	Electrical
110.1-TIS	Structural Framing
111.1-TIS	Structural Framing

11/7/2025	For Review	NOT FOR CONSTRUCTION
-----------	------------	-----------------------------

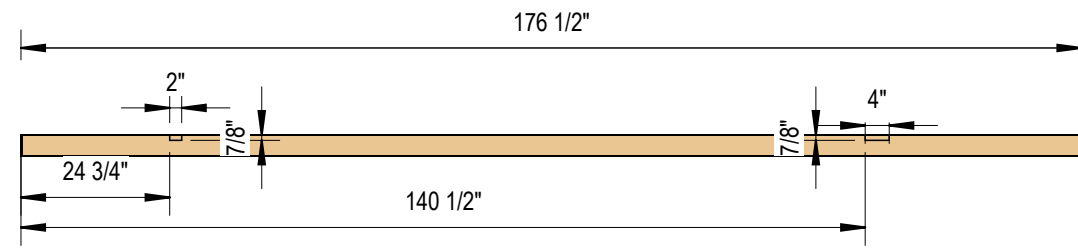

1 Top Plate
3/8" = 1'-0"

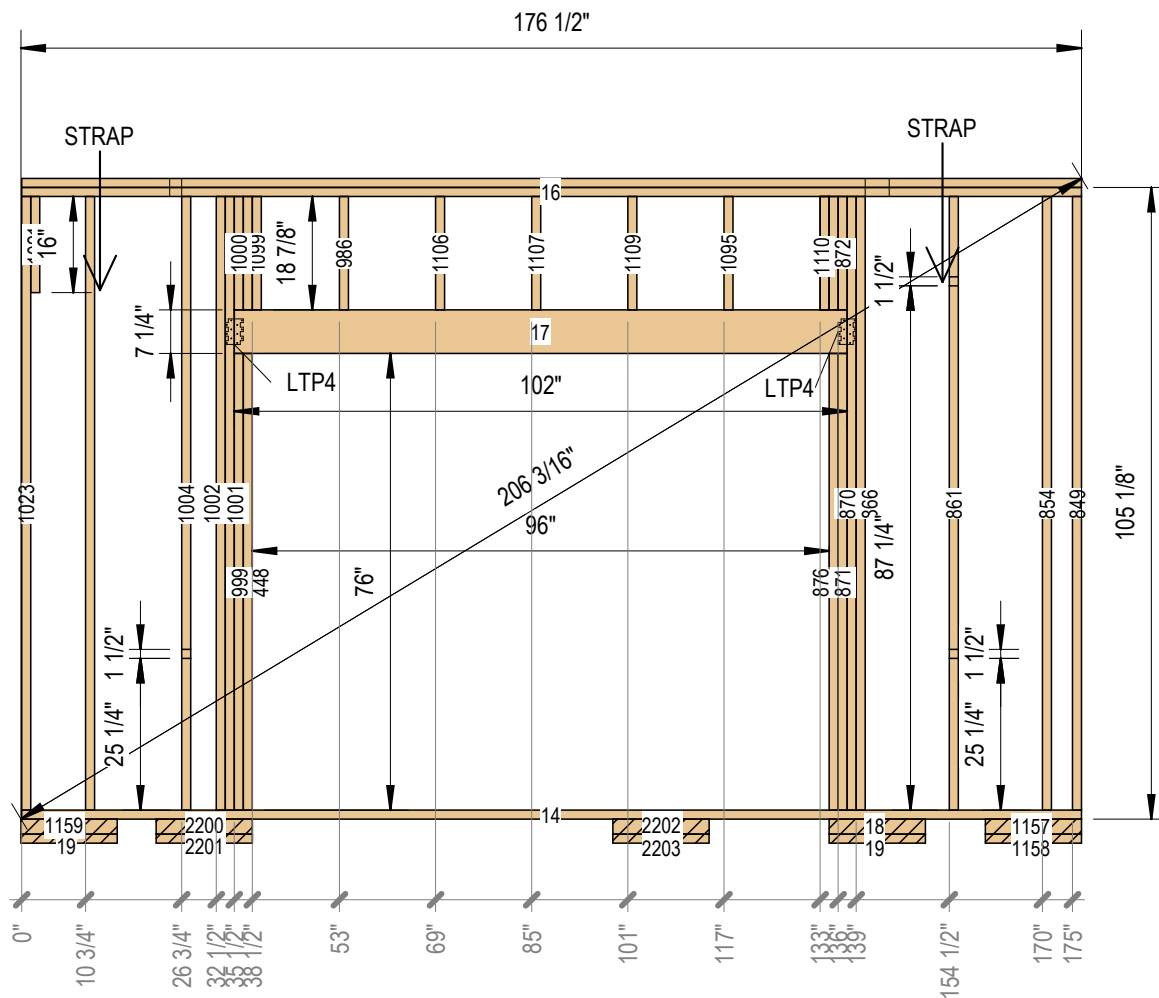

2 Framing Side A
3/8" = 1'-0"

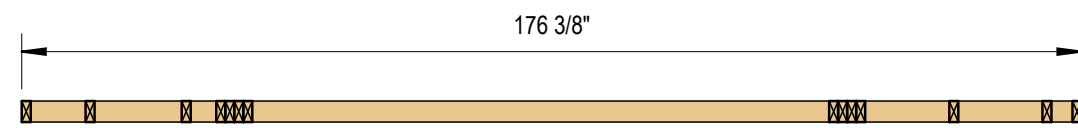

4 Bottom Plate
3/8" = 1'-0"

Structural Stud Schedule

Mark	Piece Type	Description	Structural Material	Side	Length
448	Trimmer	2x4	SPF #1/#2		76"
849	Stud	2x4	SPF #1/#2		102 1/8"
854	Stud	2x4	SPF #1/#2		102 1/8"
861	Stud	2x4	SPF #1/#2		102 1/8"
866	KingStud	2x4	SPF #1/#2		102 1/8"
870	KingStud	2x4	SPF #1/#2		102 1/8"
871	Trimmer	2x4	SPF #1/#2		76"
872	HeaderCripple	2x4	SPF #1/#2		18 7/8"
876	Trimmer	2x4	SPF #1/#2		76"
877	HeaderCripple	2x4	SPF #1/#2		18 7/8"
986	HeaderCripple	2x4	SPF #1/#2		18 7/8"
999	Trimmer	2x4	SPF #1/#2		76"
1000	HeaderCripple	2x4	SPF #1/#2		18 7/8"
1001	KingStud	2x4	SPF #1/#2		102 1/8"
1002	KingStud	2x4	SPF #1/#2		102 1/8"
1004	Stud	2x4	SPF #1/#2		102 1/8"
1008	Stud	2x4	SPF #1/#2		102 1/8"
1021	Stud	2x4	SPF #1/#2		16"
1023	Stud	2x4	SPF #1/#2		102 1/8"
1095	HeaderCripple	2x4	SPF #1/#2		18 7/8"
1099	HeaderCripple	2x4	SPF #1/#2		18 7/8"
1100	HeaderCripple	2x4	SPF #1/#2		18 7/8"
1106	HeaderCripple	2x4	SPF #1/#2		18 7/8"
1107	HeaderCripple	2x4	SPF #1/#2		18 7/8"
1109	HeaderCripple	2x4	SPF #1/#2		18 7/8"
1110	HeaderCripple	2x4	SPF #1/#2		18 7/8"
1114	HeaderCripple	2x4	SPF #1/#2		18 7/8"

Structural Horizontal Framing Schedule

Mark	Piece Type	Description	Structural Material	Side	Cut Length
14	Bottom Plate	2x4	SPF #1/#2		176 3/8"
15	Top Plate	2x4	SPF #1/#2		176 3/8"
16	Top Plate	2x4	SPF #1/#2		176 3/8"
17	Header	4x8	DF #2		102"
18	Temporary	3x4	SPF Standard		16 3/128"
19	Temporary	2x4	SPF Standard		16 1/64"
19	Temporary	2x4	SPF Standard		16 3/128"
1157	Temporary	3x4	SPF Standard		16"
1158	Temporary	2x4	SPF Standard		16"
1159	Temporary	3x4	SPF Standard		16 1/64"
2200	Temporary	3x4	SPF Standard		16 1/64"
2201	Temporary	2x4	SPF Standard		16 1/64"
2202	Temporary	3x4	SPF Standard		16 1/64"
2203	Temporary	2x4	SPF Standard		16 1/64"

Structural Connection Schedule

Type	Count	Side
LTP4	2	B



SUMMERSTONE
1550P
LOT 60
ELEV-B-LEFT

11/7/2025 For Review

NOT FOR CONSTRUCTION

Structural Framing
100.1-TEE

Vertical Wall Sheathing Schedule				
Mark	Description	Thickness	Length	Height
64	Picasso	1"	43"	108"
65	Picasso	1"	42"	108"
73	Picasso	1"	96"	28 7/8"

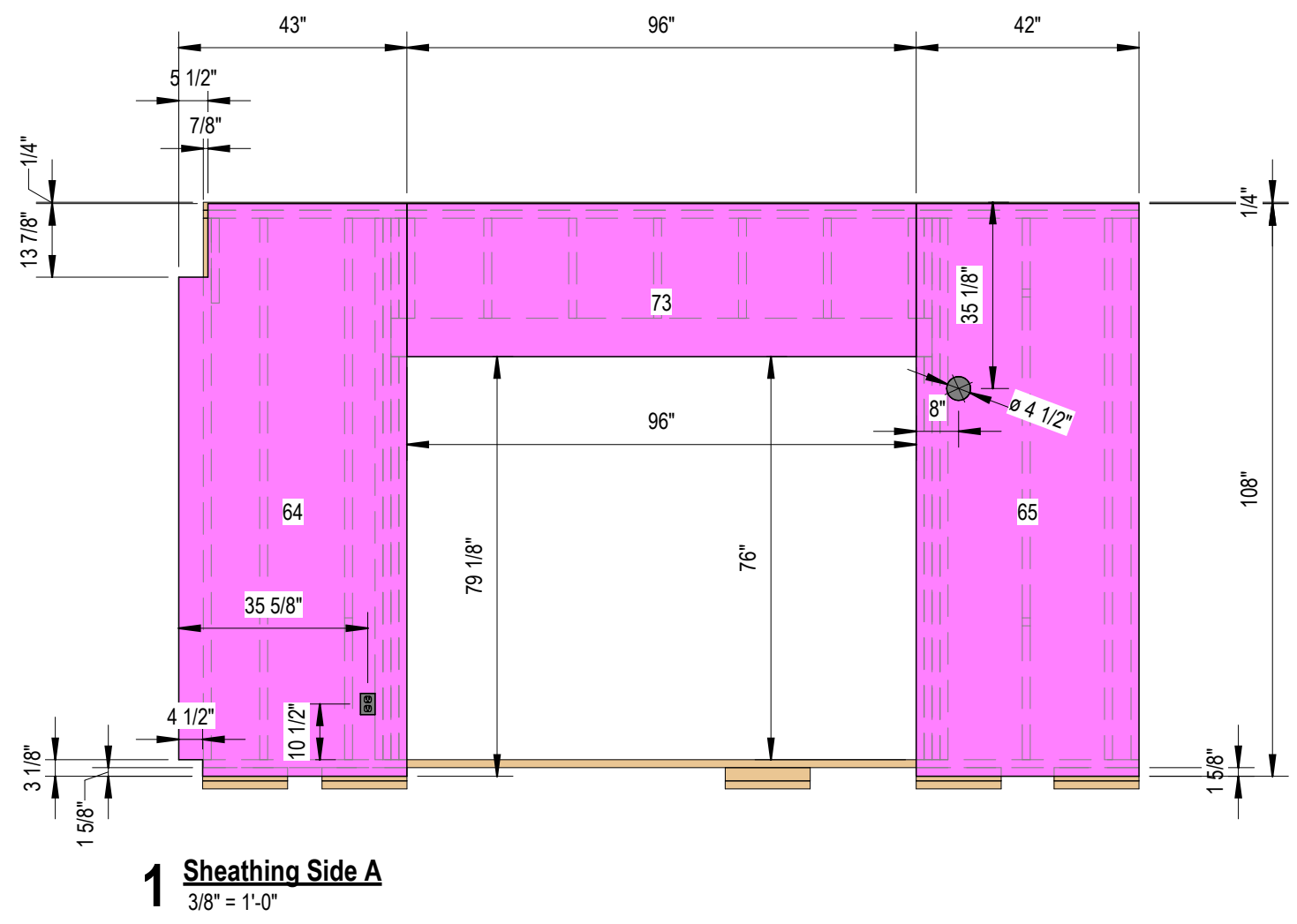

SUMMERSTONE
1550P
 LOT 60
 ELEV-B-LEFT

11/7/2025	For Review	NOT FOR CONSTRUCTION

Sheathing
100.2-TEE

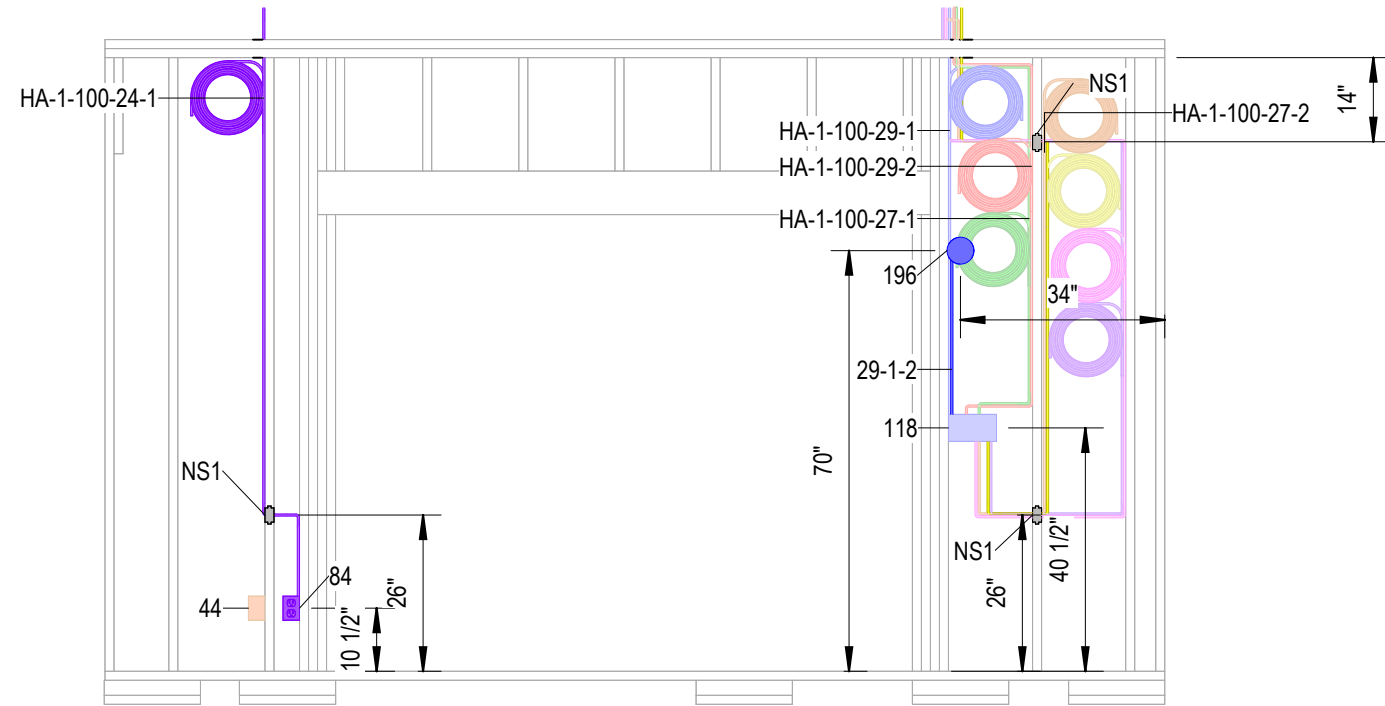

1 Electrical Side A
3/8" = 1'-0"

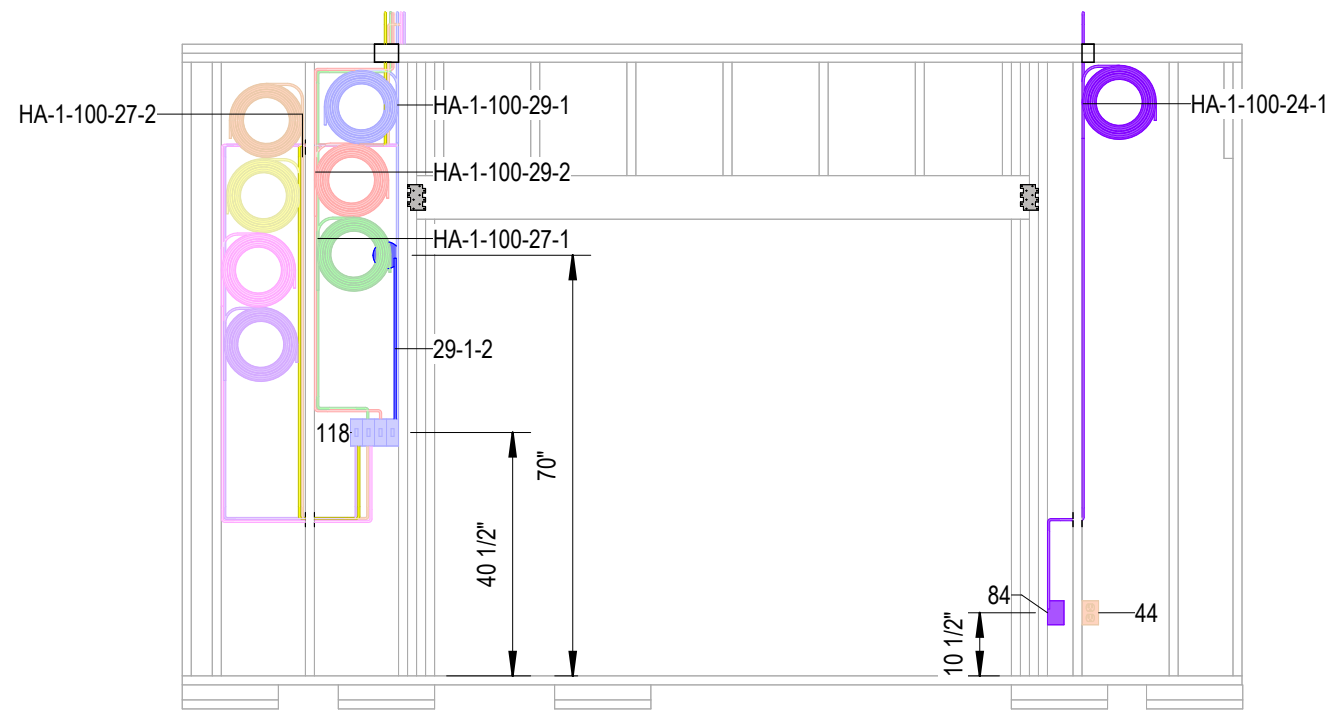

2 Electrical Side B
3/8" = 1'-0"

Electrical Fixture Schedule

Mark	Side	Box	Device-A	Device-B	Device-C	Device-D	Comments
44	B	B432A-UPC	Receptacle: T5320W				
84	A	EZ18SNW	Receptacle: GFNT1-KGY				
118	B	B455AH	Standard Switch: 14512W	Standard Switch: 14512W	3-Way Switch: 56032W	3-Way: 56032W	
196	A	EZ20CN					

Harness Assembly for TEE-100

Prefix-Quadrant-Wall-Circuit-Whip-Index	Type	Total Length	Pull To
HA-1-100-24-1	12/2	44' - 4"	JB1-6
HA-1-100-27-1	14/2	32' - 11"	JB1-4
HA-1-100-27-2	14/2	31' - 10"	Panel 110, Box 44, Device 44
HA-1-100-27-4	14/3	47' - 0"	Panel 108, Box 160, Device A
HA-1-100-29-1	14/2	42' - 2"	JB1-2
HA-1-100-29-1-2	14/2	4' - 5"	
HA-1-100-29-2	14/2	19' - 9"	Ceiling Box Fan 120

Protection Plate Schedule

Count	Type	Side
3	NS1	A



SUMMERSTONE
1550P
LOT 60
ELEV-B-LEFT

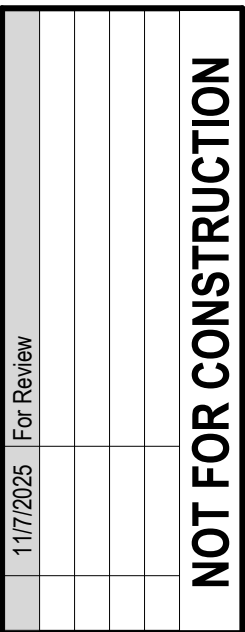

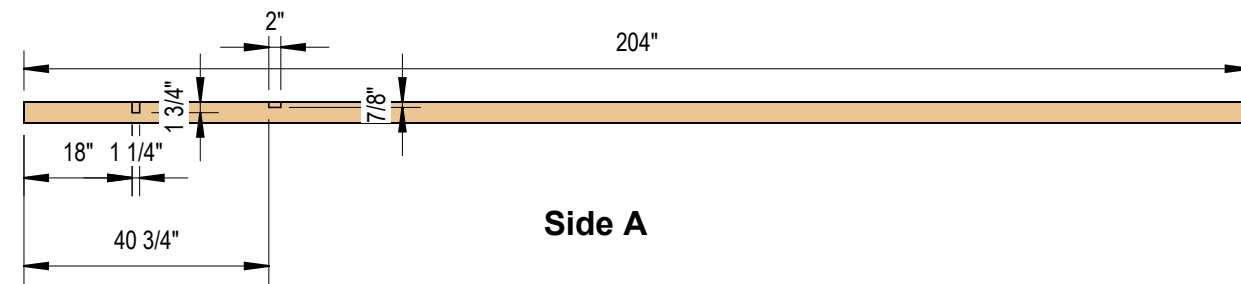

1 Top Plate
3/8" = 1'-0"

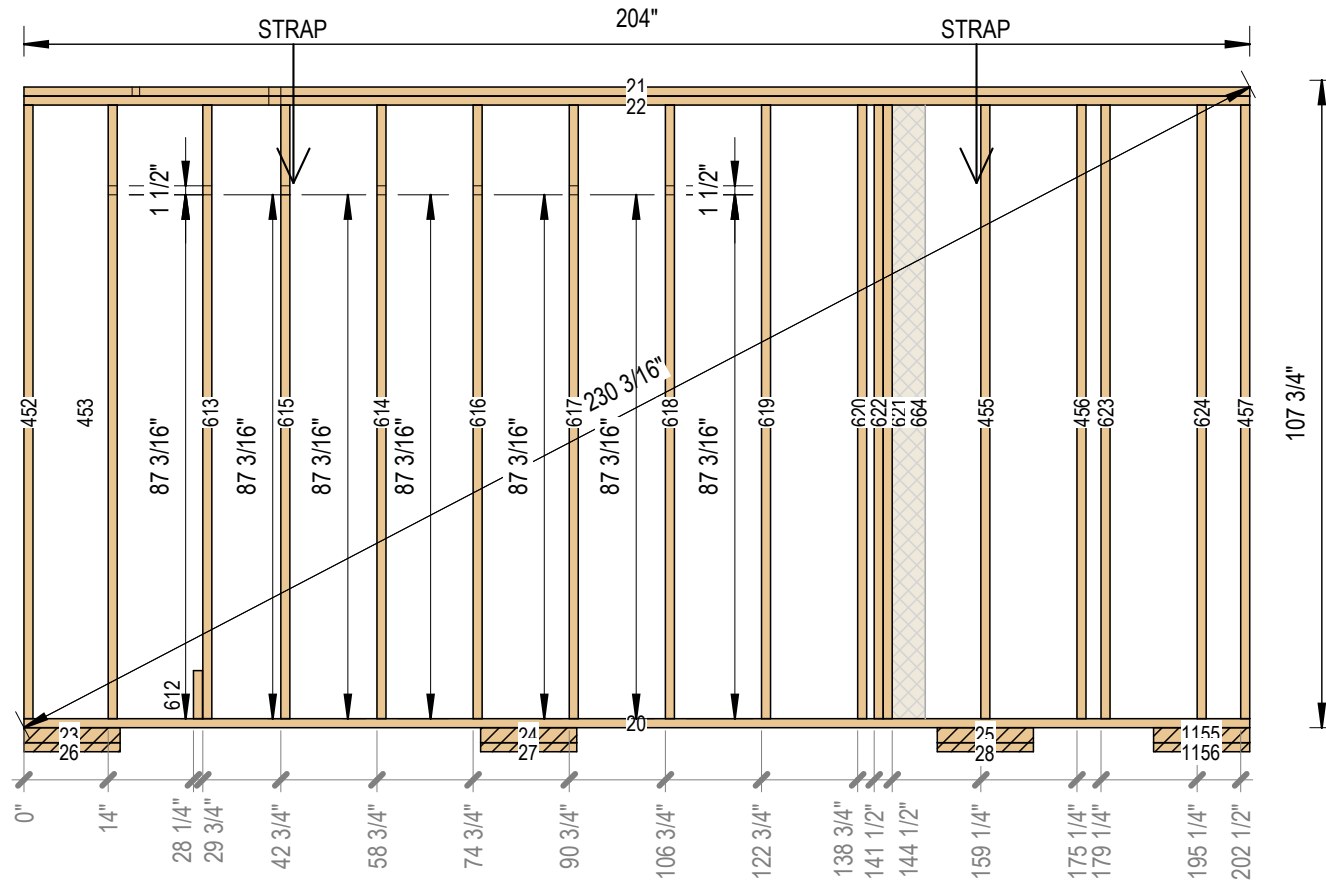

2 Framing Side A
3/8" = 1'-0"

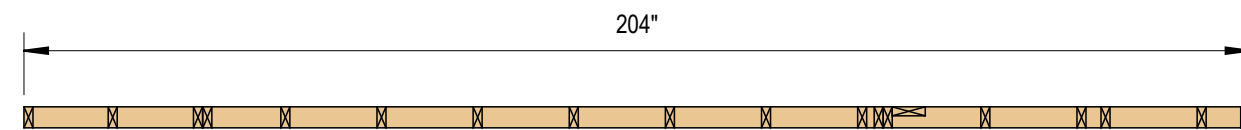

3 Bottom Plate
3/8" = 1'-0"

Structural Stud Schedule					
Mark	Piece Type	Description	Structural Material	Side	Length
452	Stud	2x4	SPF #1/#2		102 1/8"
453	Stud	2x4	SPF #1/#2		102 1/8"
455	Stud	2x4	SPF #1/#2		102 1/8"
456	Stud	2x4	SPF #1/#2		102 1/8"
457	Stud	2x4	SPF #1/#2		102 1/8"
612	Stud	2x4	SPF #1/#2		8"
613	Stud	2x4	SPF #1/#2		102 1/8"
614	Stud	2x4	SPF #1/#2		102 1/8"
615	Stud	2x4	SPF #1/#2		102 1/8"
616	Stud	2x4	SPF #1/#2		102 1/8"
617	Stud	2x4	SPF #1/#2		102 1/8"
618	Stud	2x4	SPF #1/#2		102 1/8"
619	Stud	2x4	SPF #1/#2		102 1/8"
620	Stud	2x4	SPF #1/#2		102 1/8"
621	Stud	2x4	SPF #1/#2		102 1/8"
622	Stud	2x4	SPF #1/#2		102 1/8"
623	Stud	2x4	SPF #1/#2		102 1/8"
624	Stud	2x4	SPF #1/#2		102 1/8"
664 - B	FlatStud	2x6	SPF #1/#2	B	102 1/8"

Structural Horizontal Framing Schedule					
Mark	Piece Type	Description	Structural Material	Side	Cut Length
20	Bottom Plate	2x4	SPF #1/#2		204"
21	Top Plate	2x4	SPF #1/#2		204"
22	Top Plate	2x4	SPF #1/#2		204"
23	Temporary	3x4	SPF Standard		16"
24	Temporary	3x4	SPF Standard		16"
25	Temporary	3x4	SPF Standard		16"
26	Temporary	2x4	SPF Standard		16"
27	Temporary	2x4	SPF Standard		16"
28	Temporary	2x4	SPF Standard		16"
1155	Temporary	3x4	SPF Standard		16"
1156	Temporary	2x4	SPF Standard		16"

Structural Connection Schedule		
Type	Count	Side



SUMMERSTONE
1550P
LOT 60
ELEV-B-LEFT

11/7/2025 For Review

NOT FOR CONSTRUCTION

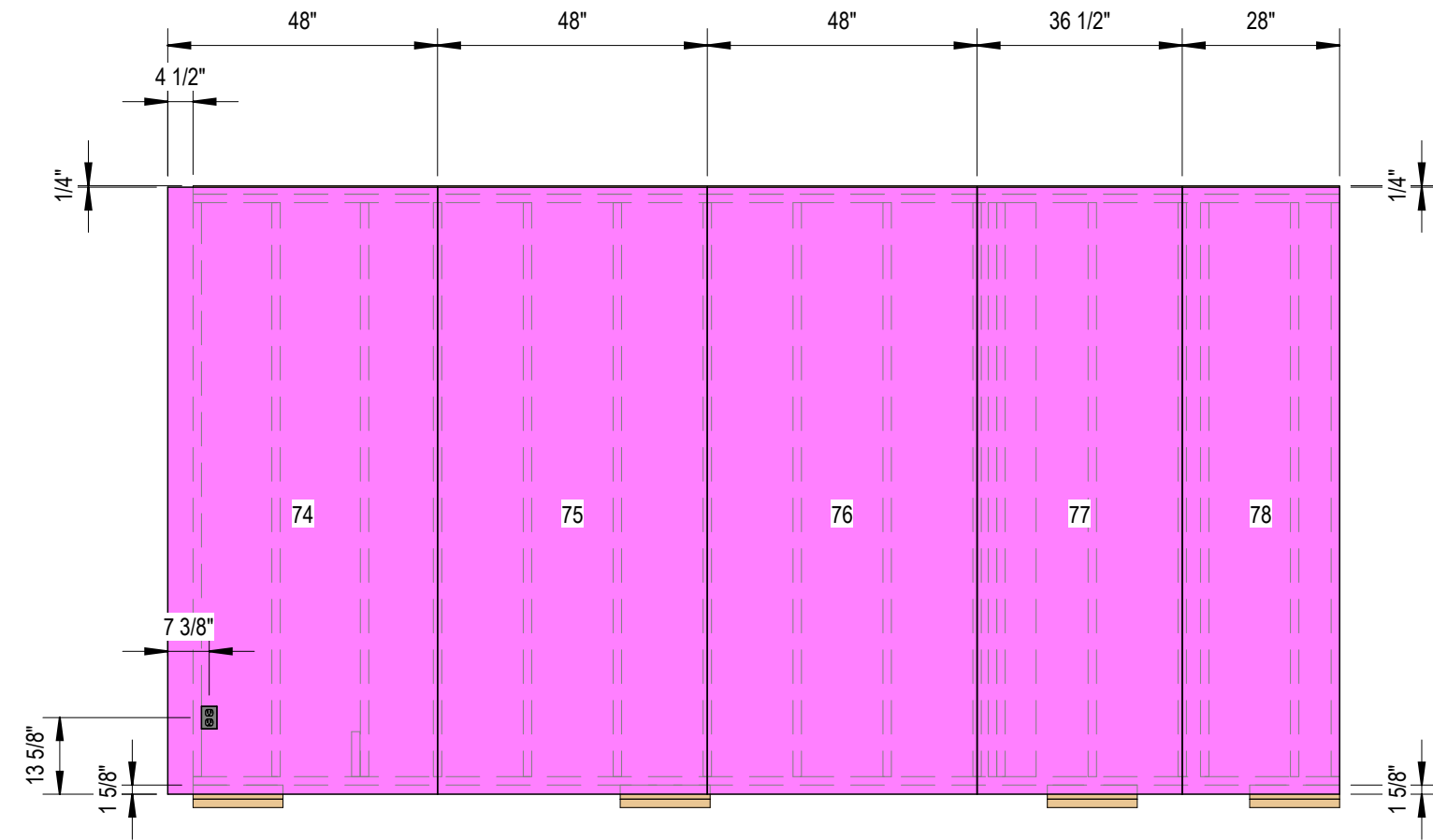

1 Sheathing Side A
3/8" = 1'-0"

Vertical Wall Sheathing Schedule				
Mark	Description	Thickne ss	Length	Height
74	Picasso	1"	48"	108"
75	Picasso	1"	48"	108"
76	Picasso	1"	48"	108"
77	Picasso	1"	36 1/2"	108"
78	Picasso	1"	28"	108"



SUMMERSTONE
1550P
LOT 60
ELEV-B-LEFT

11/7/2025	For Review					NOT FOR CONSTRUCTION

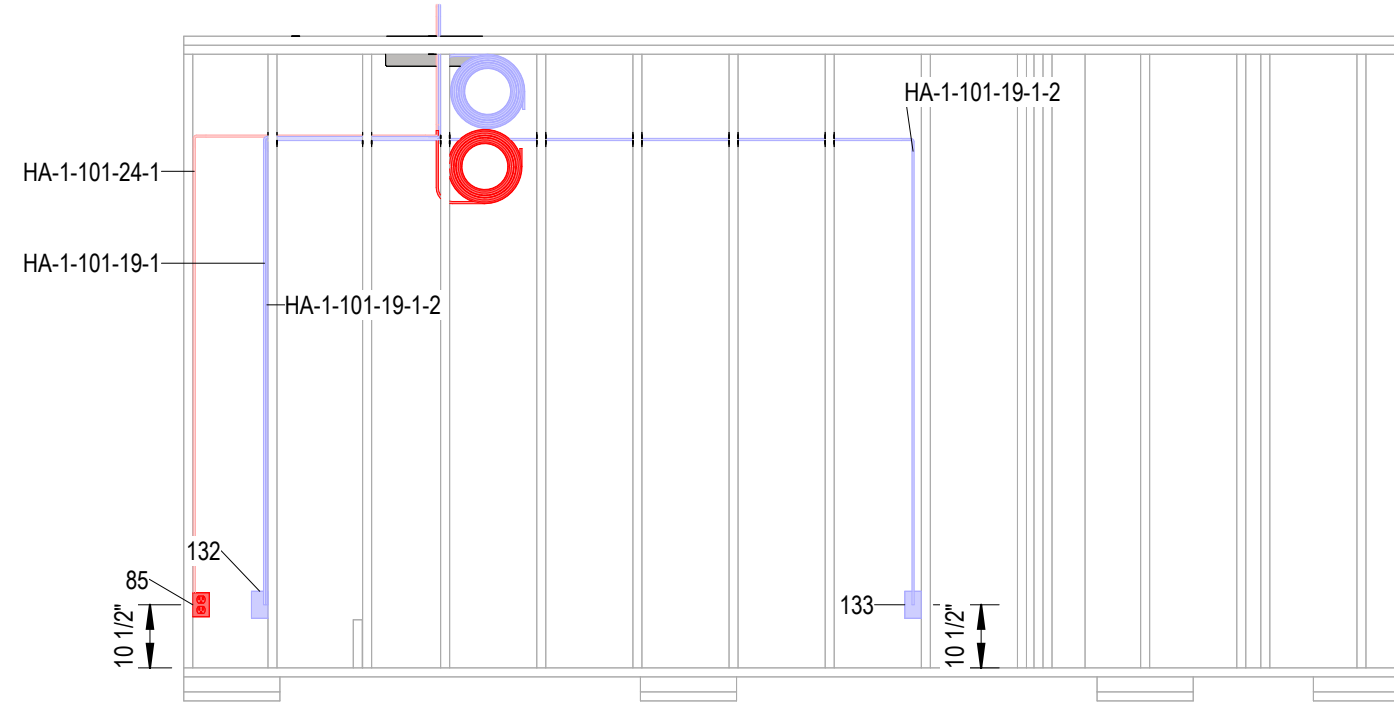

1 Electrical Side A
3/8" = 1'-0"

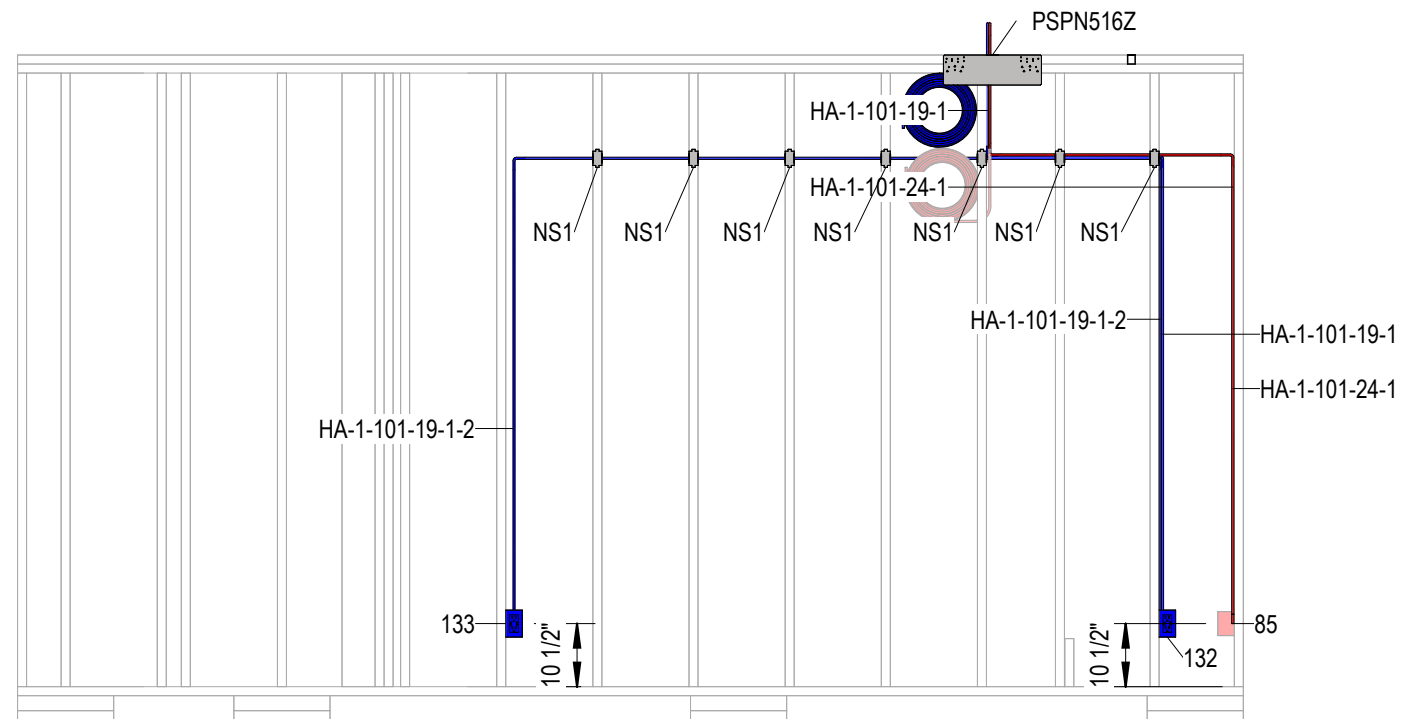

2 Electrical Side B
3/8" = 1'-0"

Electrical Fixture Schedule

Mark	Side	Box	Device-A	Device-B	Device-C	Device-D	Comments
85	A	EZ18SNW	Receptacle: GFNT1-KGY				
132	B	EZ21SBZ-ADJ	Receptacle: Leviton T5632W				
133	B	EZ21SBZ-ADJ	Receptacle: Leviton T5632W				

Harness Assembly for TEPE-101

Prefix-Quadrant-Wall-Circuit-Whip-Index	Type	Total Length	Pull To
HA-1-101-19-1	14/2	38' - 2"	JBA-1.8
HA-1-101-19-1-2	12/2	23' - 10"	
HA-1-101-24-1	12/2	42' - 1"	JB1-6

Protection Plate Schedule

Count	Type	Side
7	NS1	B
1	PSPN516Z	B



SUMMERSTONE
1550P
LOT 60
ELEV-B-LEFT

11/7/2025	For Review	NOT FOR CONSTRUCTION

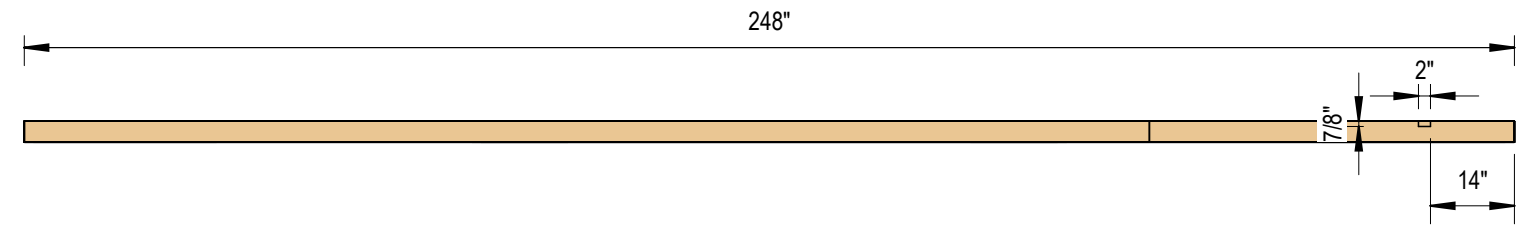

1 Top Plate
3/8" = 1'-0"

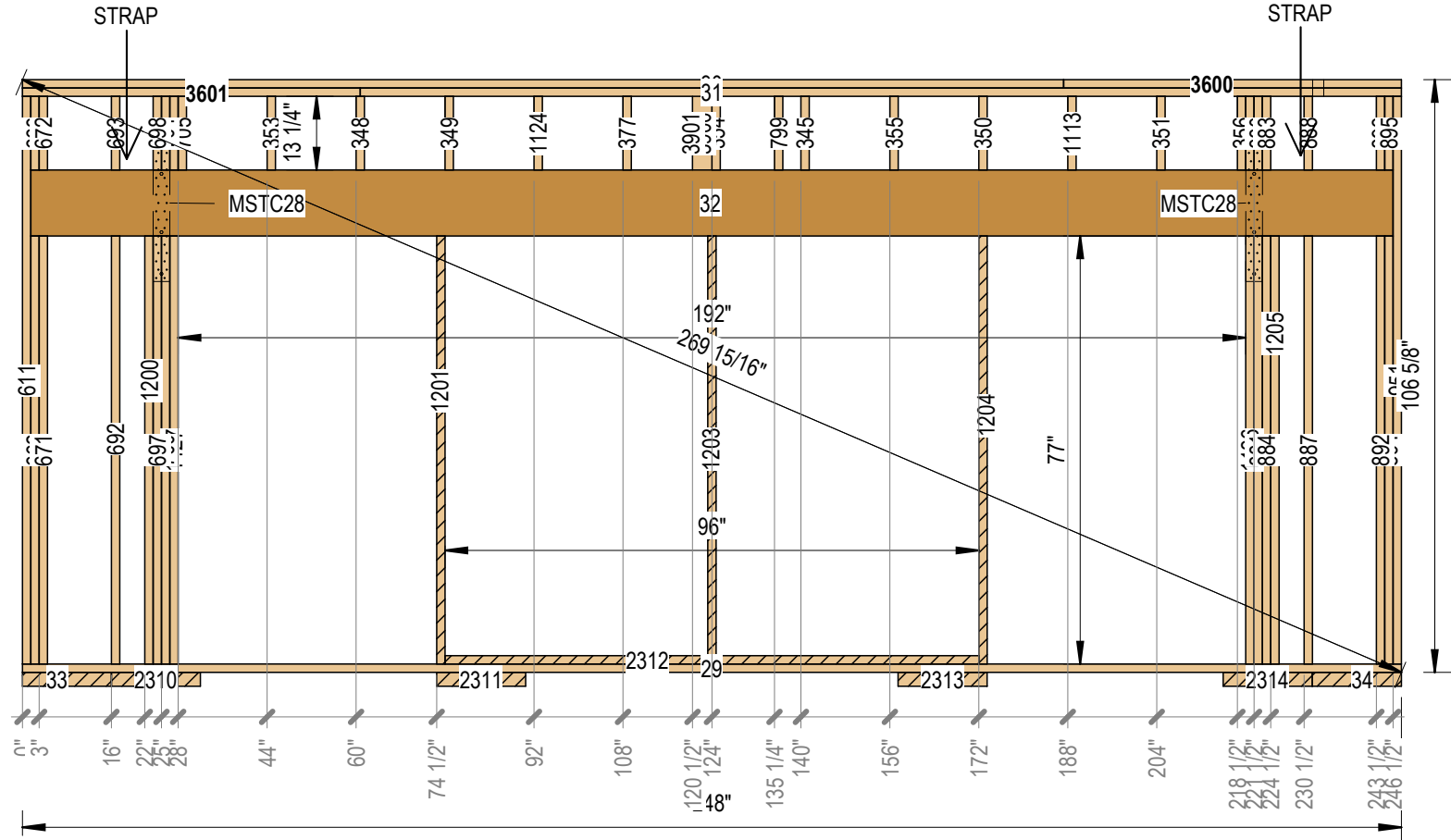

2 Framing Side A
3/8" = 1'-0"

Type	Count	Side
MSTC28	2	B

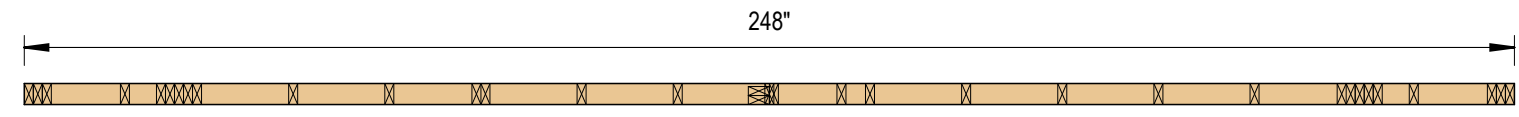

3 Bottom Plate
3/8" = 1'-0"

Structural Horizontal Framing Schedule

Mark	Piece Type	Description	Structural Material	Side	Cut Length
29	Bottom Plate	2x4	SPF #1/#2		248"
30	Top Plate	2x4	SPF #1/#2		187 1/4"
31	Top Plate	2x4	SPF #1/#2		187 1/4"
32	Header	3 1/2 x 11 7/8 SCL	1.55E Trus Joist Timberstrand LSL		245"
33	Temporary	3x4	SPF Standard		16"
34	Temporary	3x4	SPF Standard		16 3/256"
2310	Temporary	3x4	SPF Standard		16"
2311	Temporary	3x4	SPF Standard		16"
2312	Temporary	2x4	SPF Standard		96"
2313	Temporary	3x4	SPF Standard		16 3/256"
2314	Temporary	3x4	SPF Standard		16 3/256"
3600	Top Plate	2x4	SPF #1/#2		60 3/4"
3601	Top Plate	2x4	SPF #1/#2		60 3/4"

Structural Stud Schedule

Mark	Piece Type	Description	Structural Material	Side	Length
345	HeaderCripple	2x4	SPF #1/#2		13 1/4"
347	HeaderCripple	2x4	SPF #1/#2		13 1/4"
348	HeaderCripple	2x4	SPF #1/#2		13 1/4"
349	HeaderCripple	2x4	SPF #1/#2		13 1/4"
350	HeaderCripple	2x4	SPF #1/#2		13 1/4"
351	HeaderCripple	2x4	SPF #1/#2		13 1/4"
352	HeaderCripple	2x4	SPF #1/#2		13 1/4"
353	HeaderCripple	2x4	SPF #1/#2		13 1/4"
354	HeaderCripple	2x4	SPF #1/#2		13 1/4"
355	HeaderCripple	2x4	SPF #1/#2		13 1/4"
356	HeaderCripple	2x4	SPF #1/#2		13 1/4"
377	HeaderCripple	2x4	SPF #1/#2		13 1/4"
611	Stud	2x4	SPF #1/#2		102 1/8"
662	Trimmer	2x4	SPF #1/#2		77"
663	HeaderCripple	2x4	SPF #1/#2		13 1/4"
671	Trimmer	2x4	SPF #1/#2		77"
672	HeaderCripple	2x4	SPF #1/#2		13 1/4"
692	Trimmer	2x4	SPF #1/#2		77"
693	HeaderCripple	2x4	SPF #1/#2		13 1/4"
697	Trimmer	2x4	SPF #1/#2		77"
698	HeaderCripple	2x4	SPF #1/#2		13 1/4"
700	Trimmer	2x4	SPF #1/#2		77"
701	HeaderCripple	2x4	SPF #1/#2		13 1/4"
705	HeaderCripple	2x4	SPF #1/#2		13 1/4"
799	HeaderCripple	2x4	SPF #1/#2		13 1/4"
880	HeaderCripple	2x4	SPF #1/#2		13 1/4"
881	Trimmer	2x4	SPF #1/#2		77"
883	HeaderCripple	2x4	SPF #1/#2		13 1/4"
884	Trimmer	2x4	SPF #1/#2		77"
887	Stud	2x4	SPF #1/#2		77"
888	HeaderCripple	2x4	SPF #1/#2		13 1/4"
892	Trimmer	2x4	SPF #1/#2		77"
893	HeaderCripple	2x4	SPF #1/#2		13 1/4"
894	Trimmer	2x4	SPF #1/#2		77"
895	HeaderCripple	2x4	SPF #1/#2		13 1/4"
951	Stud	2x4	SPF #1/#2		102 1/8"
1113	HeaderCripple	2x4	SPF #1/#2		13 1/4"
1124	HeaderCripple	2x4	SPF #1/#2		13 1/4"
1126	Trimmer	2x4	SPF #1/#2		77"
1127	Trimmer	2x4	SPF #1/#2		77"
1200	Trimmer	2x4	SPF #1/#2		77"
1202	Temporary	2x4	SPF #1/#2		77"
1203	Temporary	2x4	SPF #1/#2		75 1/2"
1204	Temporary	2x4	SPF #1/#2		77"
1205	Trimmer	2x4	SPF #1/#2		77"
3900	HeaderCripple	2x4	SPF #1/#2		13 1/4"
3901	HeaderCripple	2x4	SPF #1/#2		13 1/4"



SUMMERSTONE
1550P
LOT 60
ELEV-B-LEFT

11/7/2025 For Review

NOT FOR CONSTRUCTION

Structural Framing
102.1-TEE

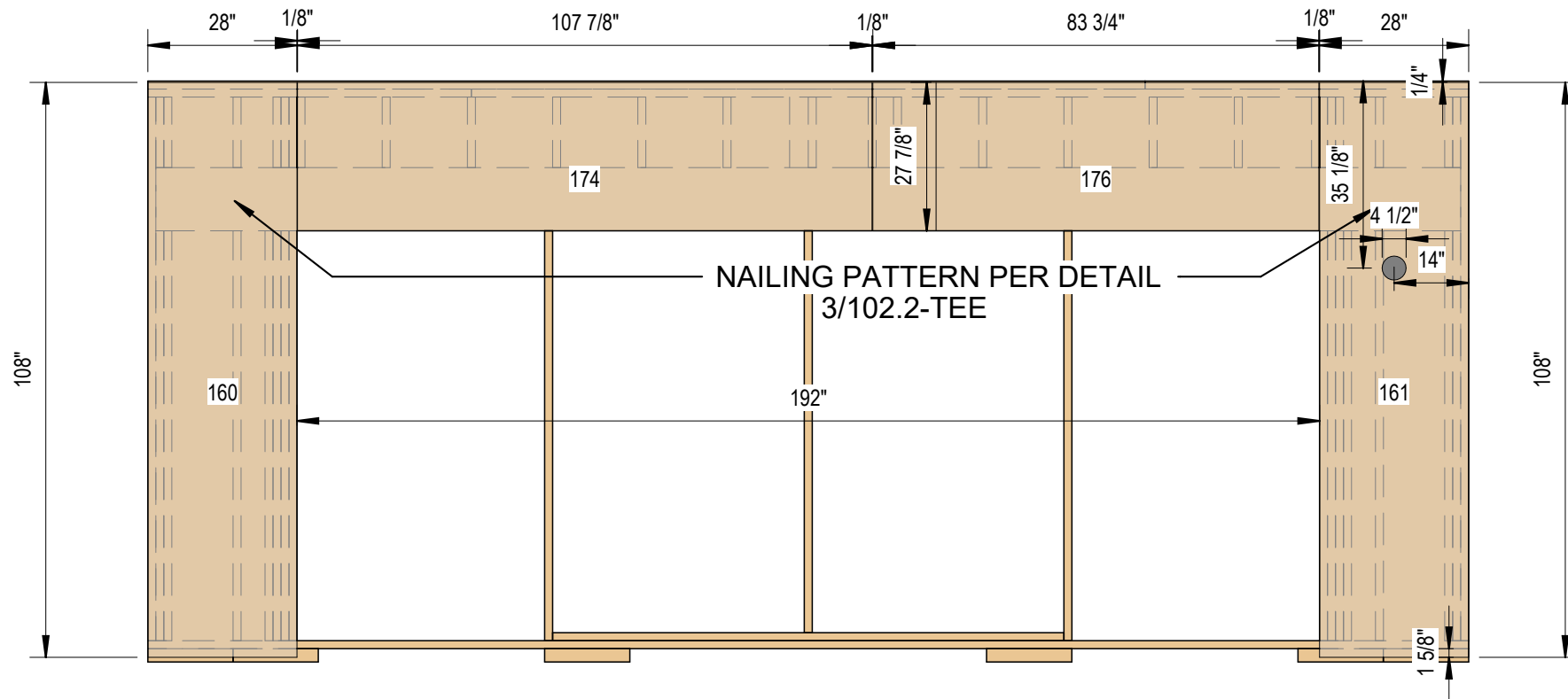

1 Sheathing OSB Side A
3/8" = 1'-0"

Mark	Description	Thickness	Length	Height
80	Picasso	1"	108"	27 7/8"
160	OSB	3/8"	28"	108"
161	OSB	3/8"	28"	108"
163	Picasso	1"	28"	72"
164	Picasso	1"	28"	72"
174	OSB	3/8"	107 7/8"	27 7/8"
175	Picasso	1"	84"	27 7/8"
176	OSB	3/8"	83 3/4"	27 7/8"



SUMMERSTONE
1550P
LOT 60
ELEV-B-LEFT

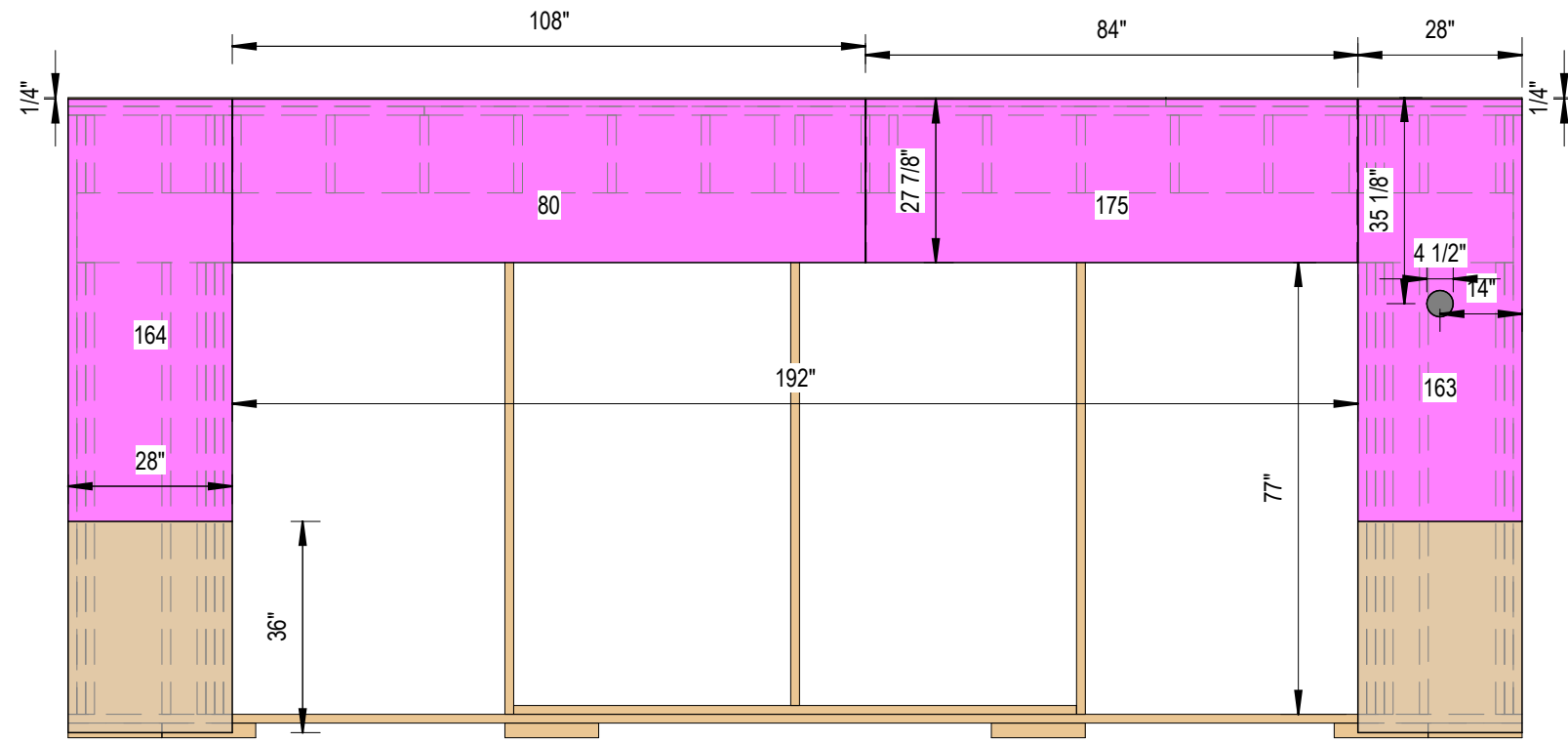

2 Sheathing Side A
3/8" = 1'-0"

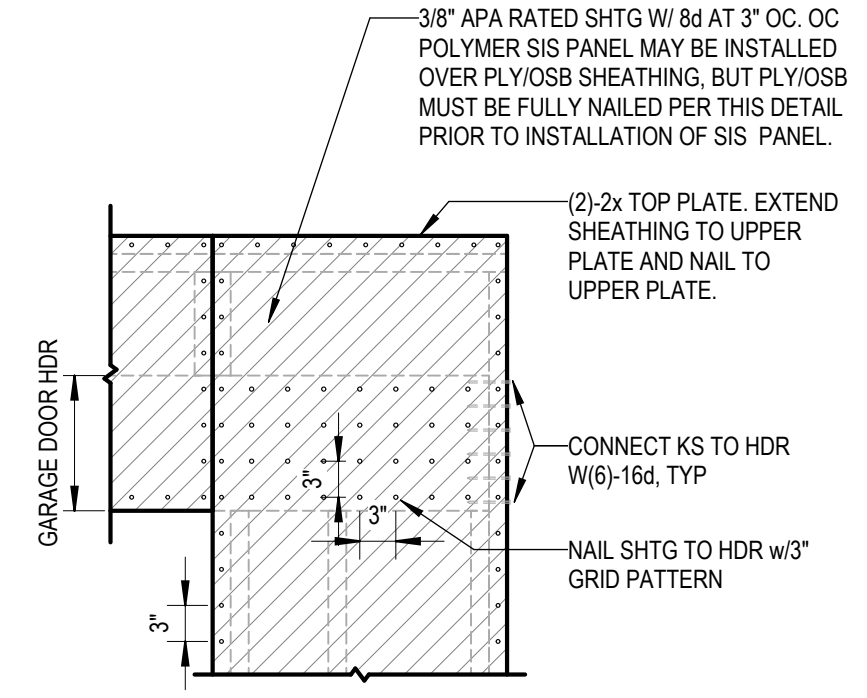

3 IRC PORTAL FRAME w/HDR (PFH)
3/4" = 1'-0"

11/7/2025 For Review

NOT FOR CONSTRUCTION

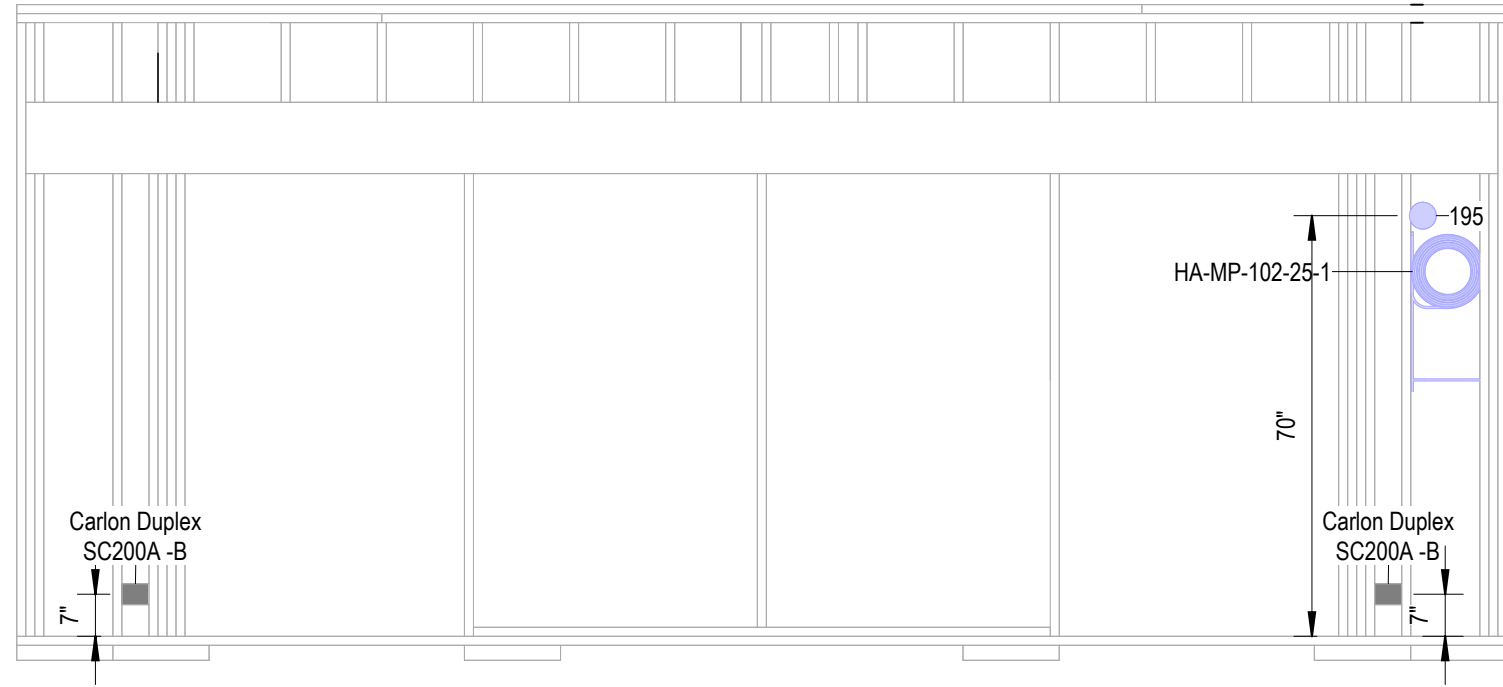

1 Electrical Side A
3/8" = 1'-0"

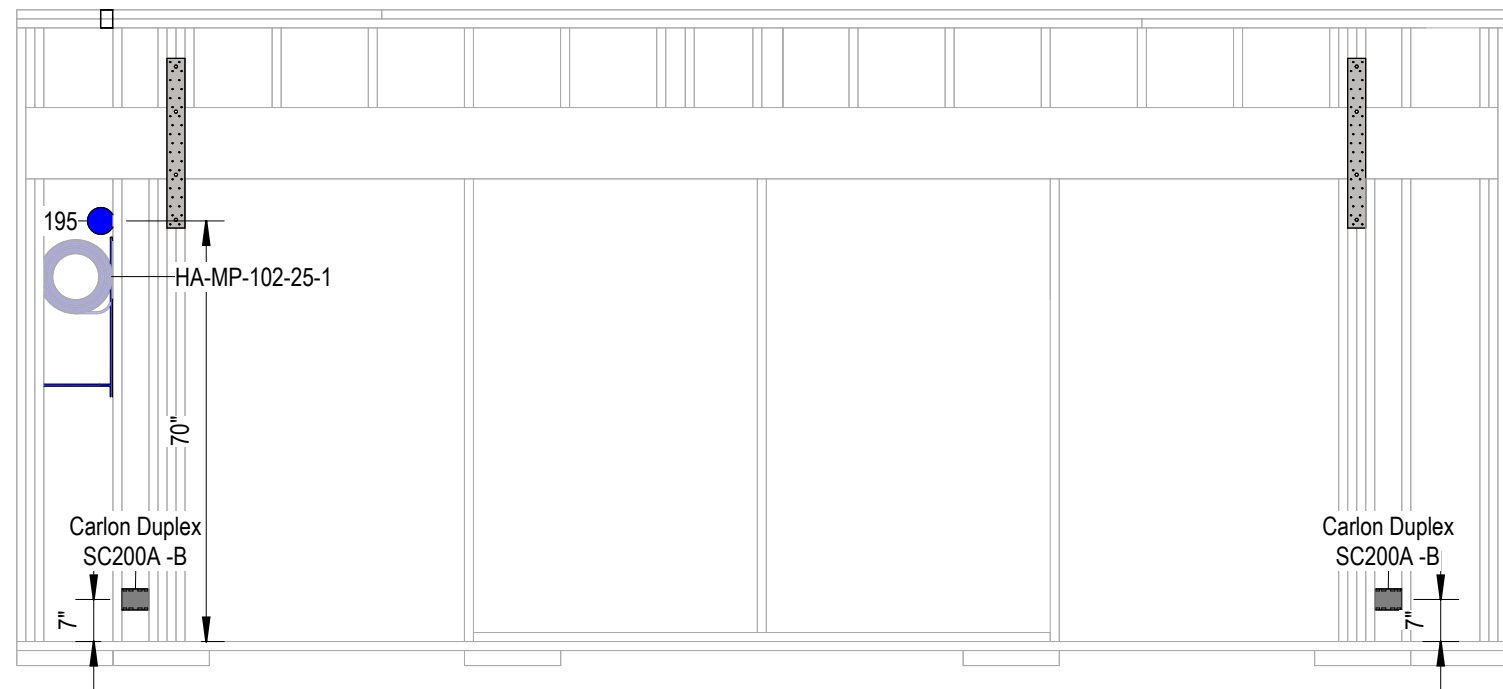

2 Electrical Side B
3/8" = 1'-0"

Electrical Fixture Schedule

Mark	Side	Box	Device-A	Device-B	Device-C	Device-D	Comments
195	B	EZ20CN					

Harness Assembly for TEE-102

Prefix-Quadrant-Wall-Circuit-Whip-Index	Type	Total Length	Pull To
HA-MP-102-25-1	14/2	5' - 5"	Panel 159, Ceiling Box 13

Protection Plate Schedule

Count	Type	Side



SUMMERSTONE
1550P
LOT 60
ELEV-B-LEFT

11/7/2025	For Review					NOT FOR CONSTRUCTION

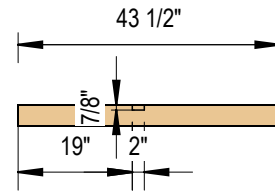

1 Top Plate
3/8" = 1'-0"

Side A

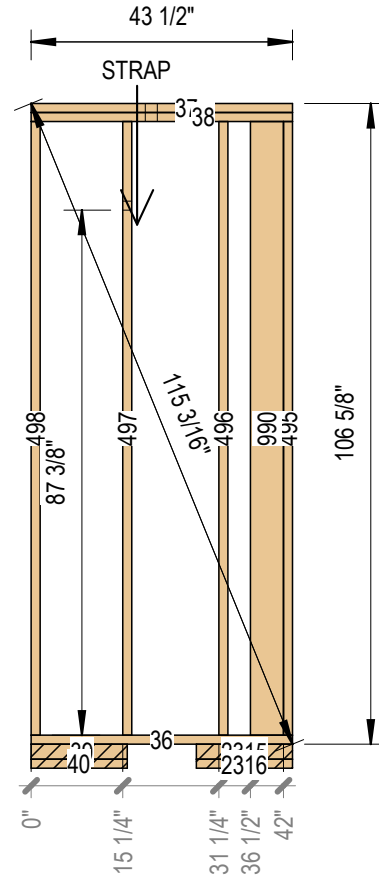

2 Framing Side A
3/8" = 1'-0"

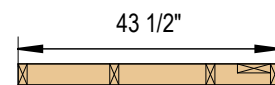

3 Bottom Plate
3/8" = 1'-0"

Side A

Structural Horizontal Framing Schedule

Mark	Piece Type	Description	Structural Material	Side	Cut Length
36	Bottom Plate	2x4	SPF #1/#2		43 1/2"
37	Top Plate	2x4	SPF #1/#2		43 1/2"
38	Top Plate	2x4	SPF #1/#2		43 1/2"
39	Temporary	3x4	SPF Standard		16"
40	Temporary	2x4	SPF Standard		16"
2315	Temporary	3x4	SPF Standard		16"
2316	Temporary	2x4	SPF Standard		16"

Structural Stud Schedule

Mark	Piece Type	Description	Structural Material	Side	Length
495	Stud	2x4	SPF #1/#2		102 1/8"
496	Stud	2x4	SPF #1/#2		102 1/8"
497	Stud	2x4	SPF #1/#2		102 1/8"
498	Stud	2x4	SPF #1/#2		102 1/8"
990 - A	FlatStud	2x6	SPF #1/#2	A	102 1/8"

Structural Connection Schedule

Type	Count	Side

11/7/2025 For Review				NOT FOR CONSTRUCTION

Vertical Wall Sheathing Schedule				
Mark	Description	Thickness	Length	Height
81	Picasso	1"	43 1/2"	108"

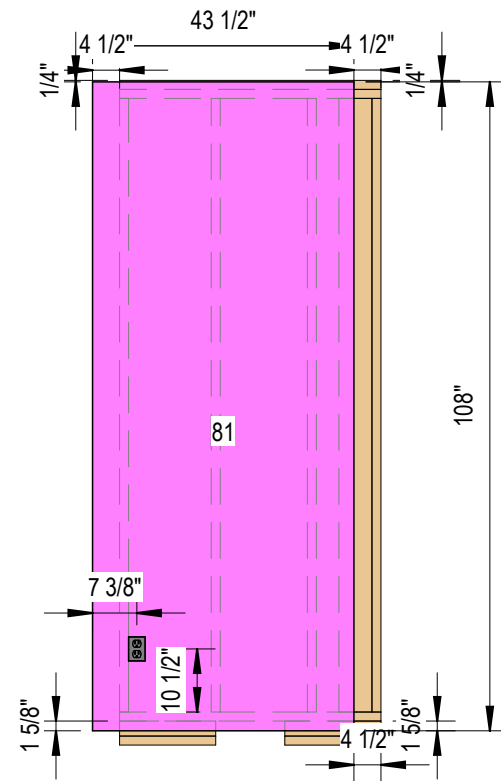

1 Sheathing Side A
3/8" = 1'-0"

SUMMERSTONE
1550P
LOT 60
ELEV-B-LEFT

11/7/2025	For Review					NOT FOR CONSTRUCTION

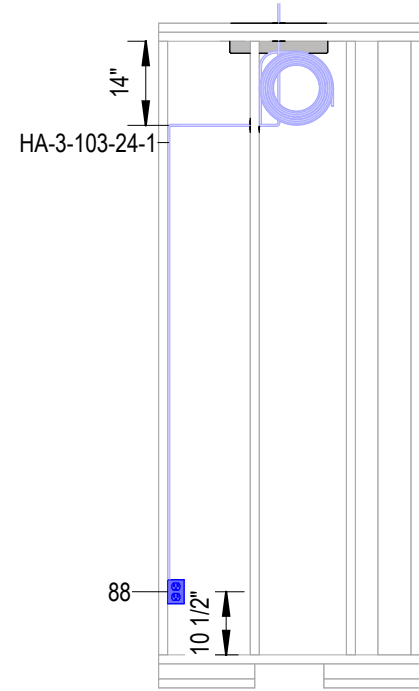

1 Electrical Side A
3/8" = 1'-0"

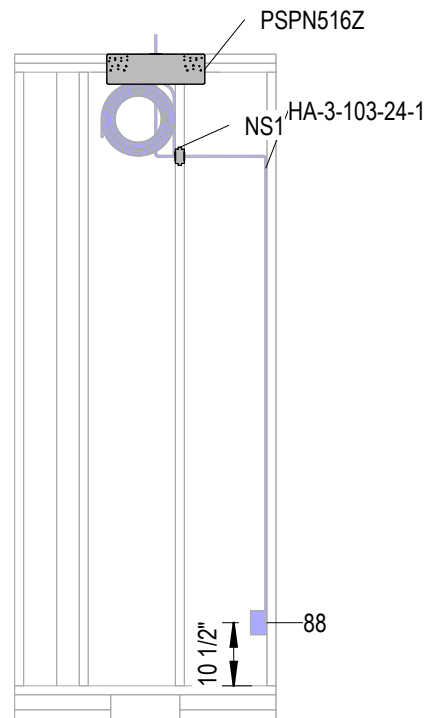

2 Electrical Side B
3/8" = 1'-0"

Electrical Fixture Schedule

Mark	Side	Box	Device-A	Device-B	Device-C	Device-D	Comments
88	A	EZ18SNW	Receptacle: GFNT1-KGY				

Protection Plate Schedule

Count	Type	Side
1	NS1	B
1	PSPN516Z	

Harness Assembly for TEE-103

Prefix-Quadrant-Wall-Circuit-Whip-Index	Type	Total Length	Pull To
HA-3-103-24-1	12/2	51' - 9"	JB3-5



SUMMERSTONE
1550P
LOT 60
ELEV-B-LEFT

11/7/2025	For Review							NOT FOR CONSTRUCTION
-----------	------------	--	--	--	--	--	--	-----------------------------

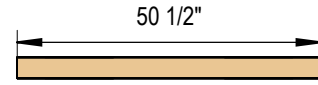

Side A

1 Top Plate
3/8" = 1'-0"

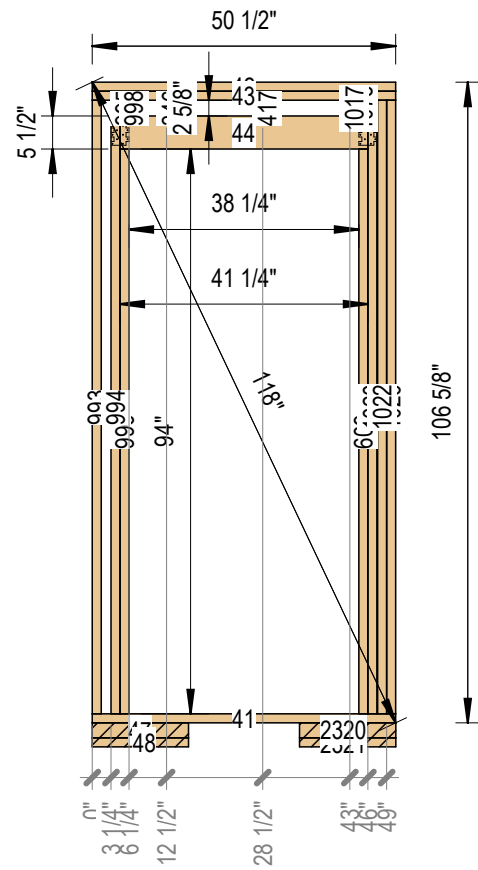

2 Framing Side A
3/8" = 1'-0"

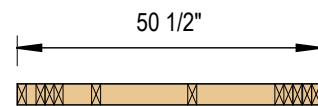

Side A

3 Bottom Plate
3/8" = 1'-0"

Structural Horizontal Framing Schedule

Mark	Piece Type	Description	Structural Material	Side	Cut Length
41	Bottom Plate	2x4	SPF #1/#2		50 1/2"
42	Top Plate	2x4	SPF #1/#2		50 1/2"
43	Top Plate	2x4	SPF #1/#2		50 1/2"
44	Header	4x6	DF #2		41 1/4"
47	Temporary	3x4	SPF Standard		16 7/256"
49	Temporary	2x4	SPF Standard		16 7/256"
2320	Temporary	3x4	SPF Standard		16 7/256"
2321	Temporary	2x4	SPF Standard		16 7/256"

Structural Stud Schedule

Mark	Piece Type	Description	Structural Material	Side	Length
346	HeaderCripple	2x4	SPF #1/#2		2 5/8"
417	HeaderCripple	2x4	SPF #1/#2		2 5/8"
609	Trimmer	2x4	SPF #1/#2		94"
993	Stud	2x4	SPF #1/#2		102 1/8"
994	KingStud	2x4	SPF #1/#2		102 1/8"
995	HeaderCripple	2x4	SPF #1/#2		2 5/8"
996	Trimmer	2x4	SPF #1/#2		94"
998	HeaderCripple	2x4	SPF #1/#2		2 5/8"
1017	HeaderCripple	2x4	SPF #1/#2		2 5/8"
1020	KingStud	2x4	SPF #1/#2		102 1/8"
1022	Stud	2x4	SPF #1/#2		102 1/8"
1026	Stud	2x4	SPF #1/#2		102 1/8"
1075	HeaderCripple	2x4	SPF #1/#2		2 5/8"

Structural Connection Schedule

Type	Count	Side
LTP4	2	B

SUMMERSTONE
1550P
LOT 60
ELEV-B-LEFT

11/7/2025 For Review
NOT FOR CONSTRUCTION

Vertical Wall Sheathing Schedule				
Mark	Description	Thickness	Length	Height
82	Picasso	1"	6 1/8"	108"
83	Picasso	1"	38 1/4"	10 7/8"
169	Picasso	1"	10 5/8"	108"

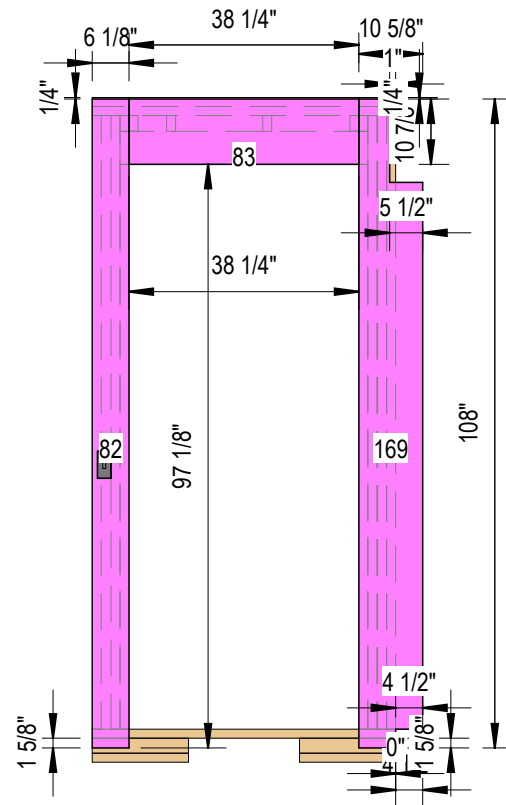

1 Sheathing Side A
3/8" = 1'-0"

SUMMERSTONE
1550P
LOT 60
ELEV-B-LEFT

11/7/2025	For Review					NOT FOR CONSTRUCTION

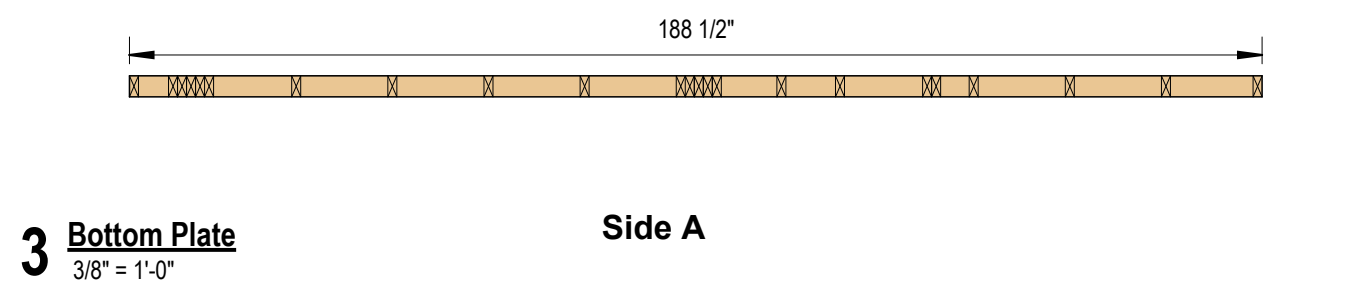
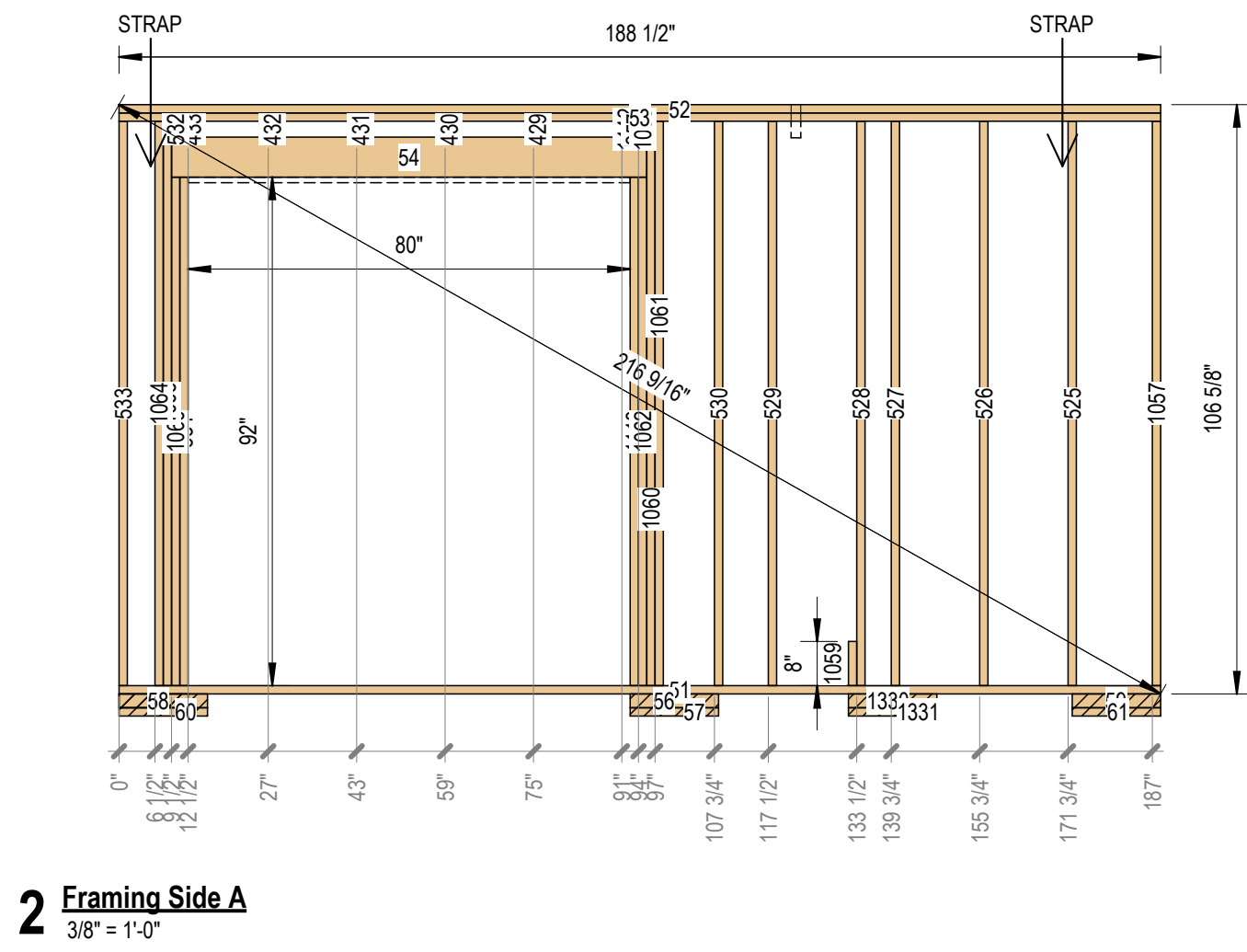
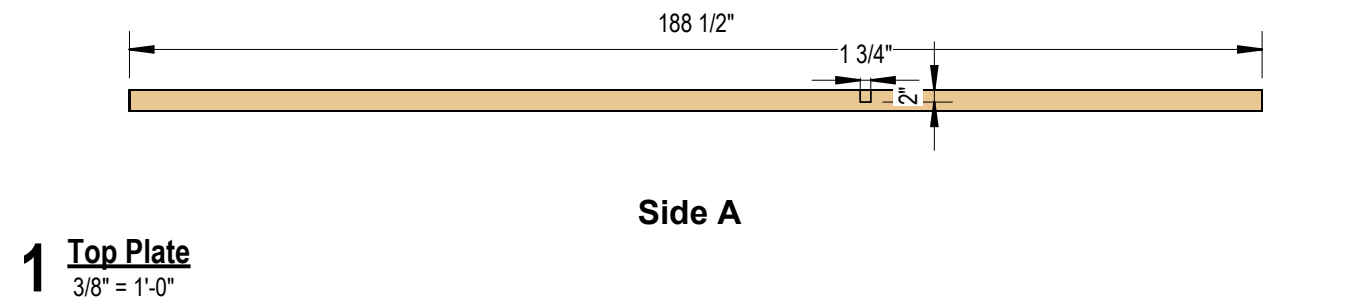

Structural Horizontal Framing Schedule

Mark	Piece Type	Description	Structural Material	Side	Cut Length
51	Bottom Plate	2x4	SPF #1/#2		188 1/2"
52	Top Plate	2x4	SPF #1/#2		188 1/2"
53	Top Plate	2x4	SPF #1/#2		188 1/2"
54	Header	4x8	DF #2		86"
55	Temporary	3x4	SPF Standard		12 1/2"
56	Temporary	3x4	SPF Standard		16"
57	Temporary	2x4	SPF Standard		16"
58	Temporary	3x4	SPF Standard		16 1/128"
59	Temporary	3x4	SPF Standard		16"
60	Temporary	2x4	SPF Standard		16 1/128"
61	Temporary	2x4	SPF Standard		16"
1330	Temporary	3x4	SPF Standard		16"
1331	Temporary	2x4	SPF Standard		16"

Structural Stud Schedule

Mark	Piece Type	Description	Structural Material	Side	Length
357	HeaderCripple	2x4	SPF #1/#2		2 7/8"
429	HeaderCripple	2x4	SPF #1/#2		2 7/8"
430	HeaderCripple	2x4	SPF #1/#2		2 7/8"
431	HeaderCripple	2x4	SPF #1/#2		2 7/8"
432	HeaderCripple	2x4	SPF #1/#2		2 7/8"
433	HeaderCripple	2x4	SPF #1/#2		2 7/8"
434	HeaderCripple	2x4	SPF #1/#2		2 7/8"
525	Stud	2x4	SPF #1/#2		102 1/8"
526	Stud	2x4	SPF #1/#2		102 1/8"
527	Stud	2x4	SPF #1/#2		102 1/8"
528	Stud	2x4	SPF #1/#2		102 1/8"
529	Stud	2x4	SPF #1/#2		102 1/8"
530	Stud	2x4	SPF #1/#2		102 1/8"
531	Trimmer	2x4	SPF #1/#2		92"
532	KingStud	2x4	SPF #1/#2		2 7/8"
533	Stud	2x4	SPF #1/#2		102 1/8"
1057	Stud	2x4	SPF #1/#2		102 1/8"
1059	Stud	2x4	SPF #1/#2		8"
1060	Stud	2x4	SPF #1/#2		102 1/8"
1061	Stud	2x4	SPF #1/#2		102 1/8"
1062	Trimmer	2x4	SPF #1/#2		92"
1063	HeaderCripple	2x4	SPF #1/#2		2 7/8"
1064	Trimmer	2x4	SPF #1/#2		102 1/8"
1065	Trimmer	2x4	SPF #1/#2		102 1/8"
1066	Trimmer	2x4	SPF #1/#2		92"
1118	Trimmer	2x4	SPF #1/#2		92"
1142	HeaderCripple	2x4	SPF #1/#2		2 7/8"

Structural Connection Schedule

Type	Count	Side



SUMMERSTONE
1550P
LOT 60
ELEV-B-LEFT

11/7/2025 For Review	NOT FOR CONSTRUCTION
----------------------	-----------------------------

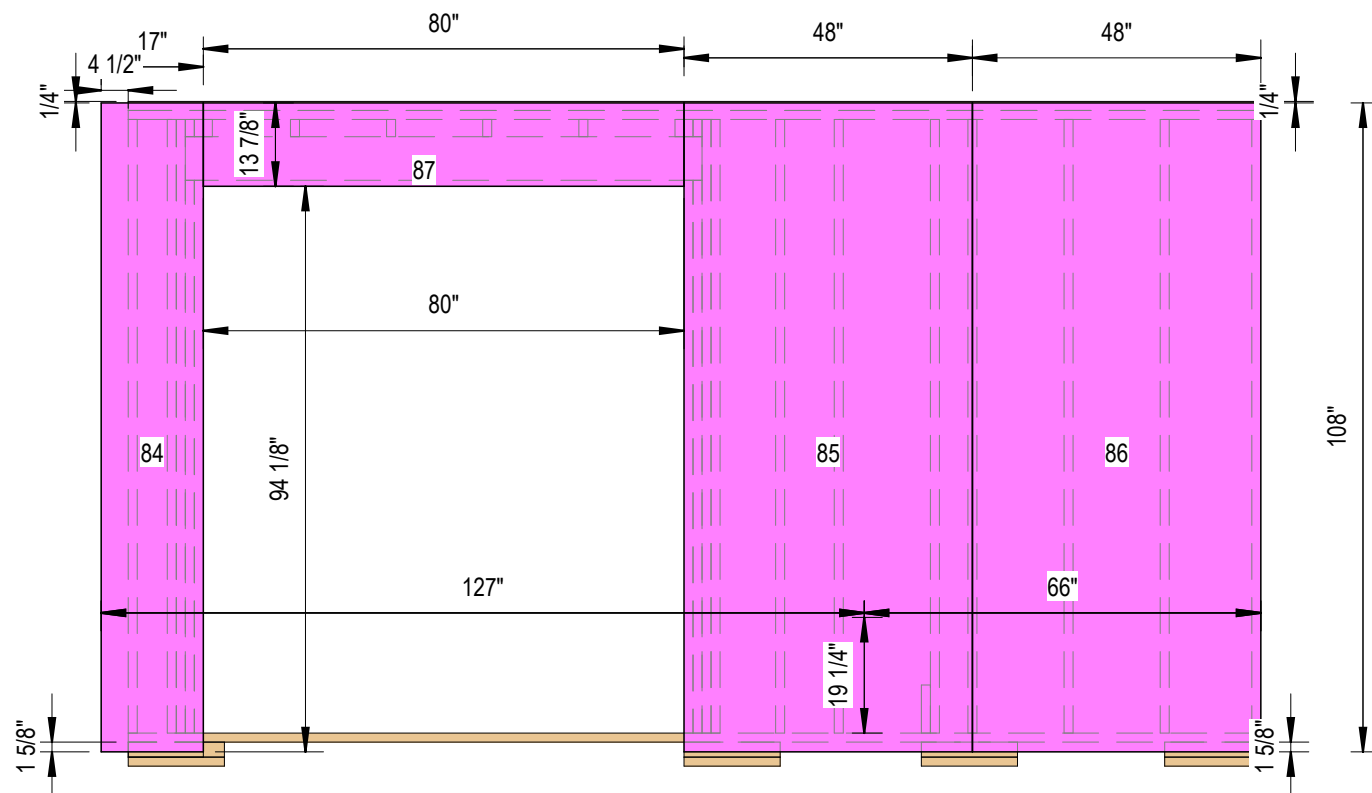

1 Sheathing Side A
3/8" = 1'-0"

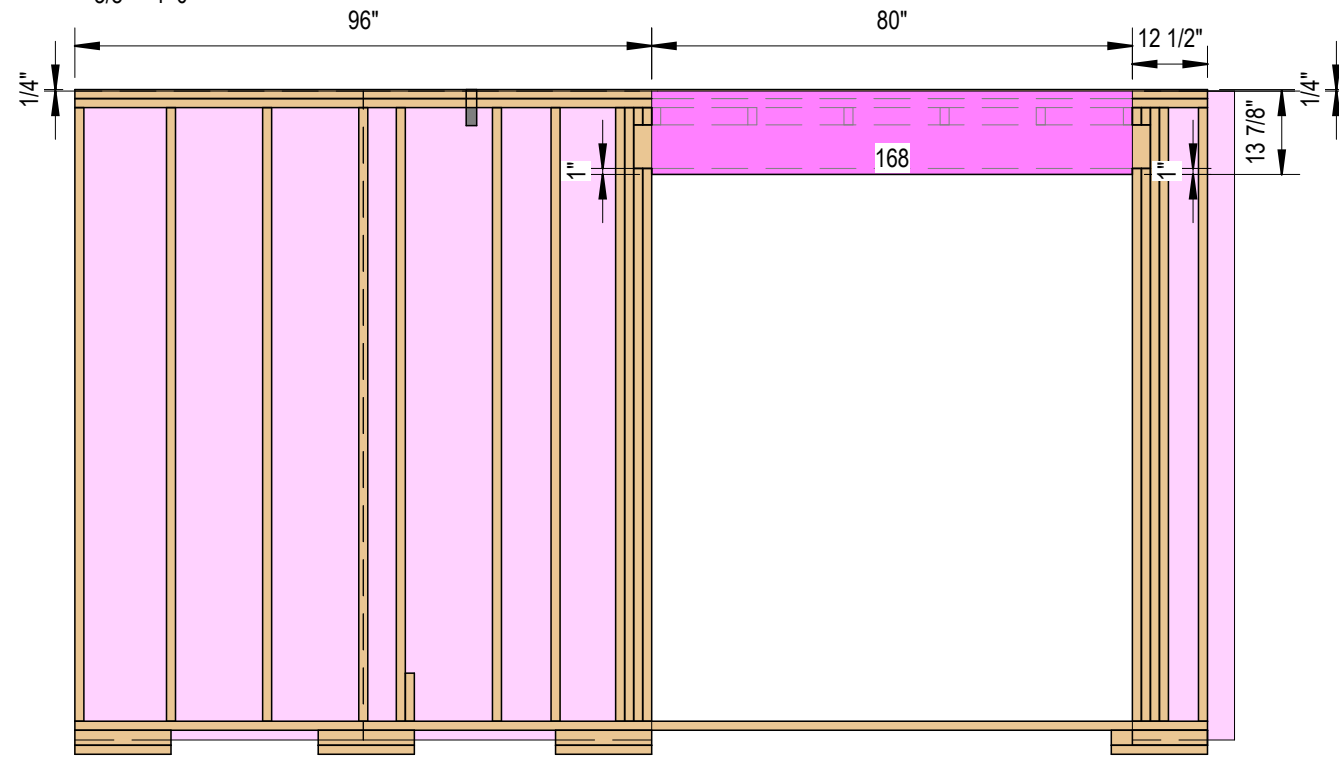

2 Sheathing Side B
3/8" = 1'-0"

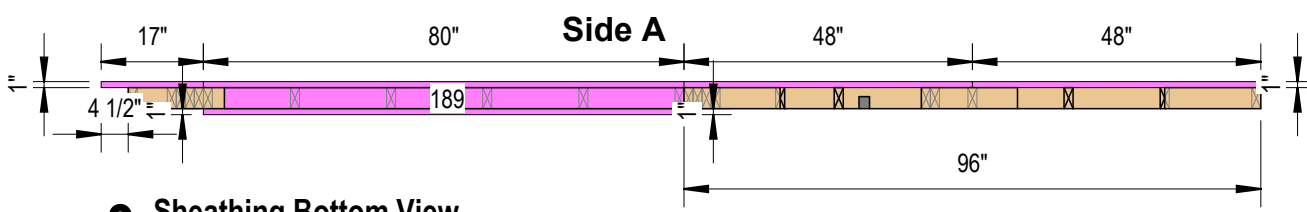

3 Sheathing Bottom View
3/8" = 1'-0"

Vertical Wall Sheathing Schedule				
Mark	Description	Thickness	Length	Height
84	Picasso	1"	17"	108"
85	Picasso	1"	48"	108"
86	Picasso	1"	48"	108"
87	Picasso	1"	80"	13 7/8"
168	Picasso	1"	80"	13 7/8"

Horizontal Sheathing Schedule				
Mark	Description	Thickness	Length	Width
189	Picasso	1"	80"	3 1/2"

SUMMERSTONE
1550P
LOT 60
ELEV-B-LEFT

11/7/2025	For Review	NOT FOR CONSTRUCTION

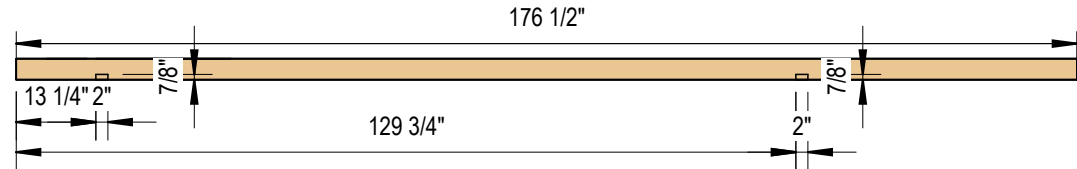

1 Top Plate
3/8" = 1'-0"

Side A

Structural Horizontal Framing Schedule

Mark	Piece Type	Description	Structural Material	Side	Cut Length
11 - B	Flat Blocking	2x6	SPF #1/#2	B	6 3/4"
62	Bottom Plate	2x4	Pressure Treated SPF Standard		176 1/2"
63	Top Plate	2x4	SPF #1/#2		176 1/2"
1175 - B	Flat Blocking	2x6	SPF #1/#2	B	22 1/2"

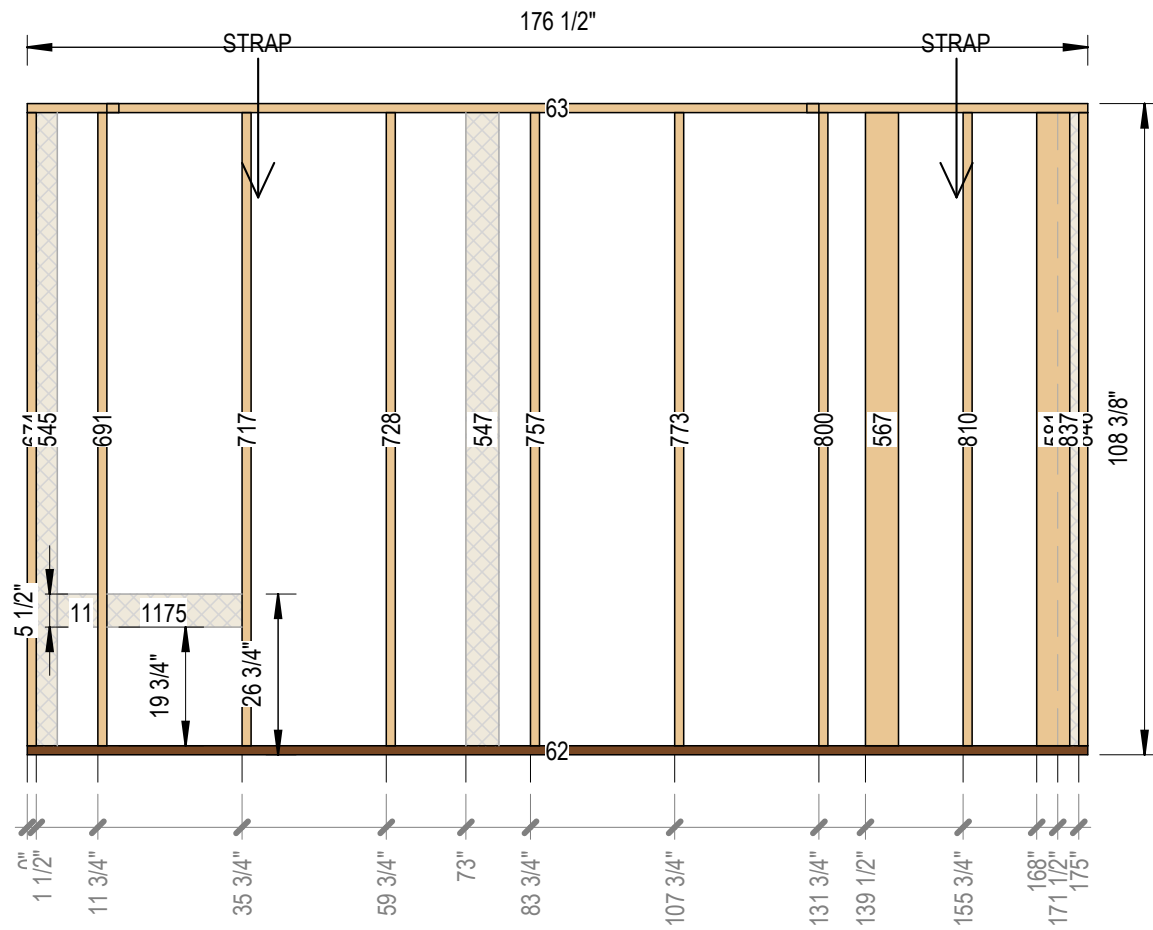

2 Framing Side A
3/8" = 1'-0"

Structural Stud Schedule

Mark	Piece Type	Description	Structural Material	Side	Length
545 - B	FlatStud	2x4	SPF #1/#2	B	105 3/8"
547 - B	FlatStud	2x6	SPF #1/#2	B	105 3/8"
567 - A	FlatStud	2x6	SPF #1/#2	A	105 3/8"
581 - A	FlatStud	2x6	SPF #1/#2	A	105 3/8"
674	Stud	2x4	SPF #1/#2		105 3/8"
691	Stud	2x4	SPF #1/#2		105 3/8"
717	Stud	2x4	SPF #1/#2		105 3/8"
728	Stud	2x4	SPF #1/#2		105 3/8"
757	Stud	2x4	SPF #1/#2		105 3/8"
773	Stud	2x4	SPF #1/#2		105 3/8"
800	Stud	2x4	SPF #1/#2		105 3/8"
810	Stud	2x4	SPF #1/#2		105 3/8"
837 - B	FlatStud	2x4	SPF #1/#2	B	105 3/8"
846	Stud	2x4	SPF #1/#2		105 3/8"

Structural Connection Schedule

Type	Count	Side
------	-------	------

4 Bottom Plate
3/8" = 1'-0"

Side A

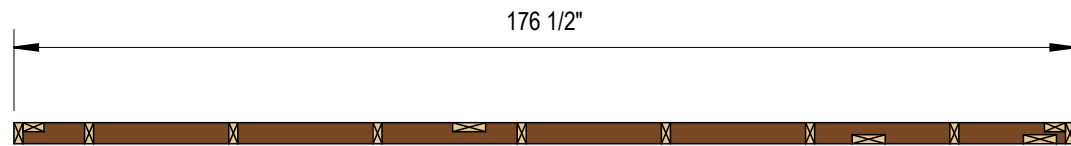

SUMMERSTONE
1550P
LOT 60
ELEV-B-LEFT

11/7/2025 For Review
NOT FOR CONSTRUCTION

Structural Framing
106.1-TIE

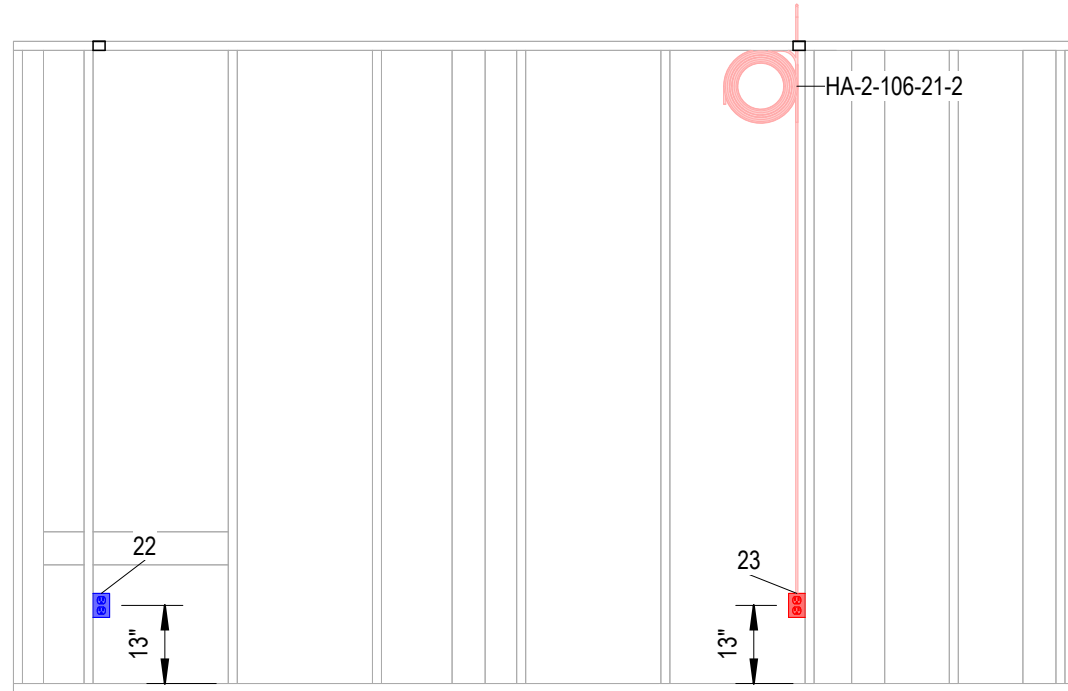

Electrical Fixture Schedule							
Mark	Side	Box	Device-A	Device-B	Device-C	Device-D	Comments
22	A	EZ18SNW	Receptacle: T5320W				
23	A	EZ18SNW	Receptacle: T5320W				

Protection Plate Schedule		
Count	Type	Side

Harness Assembly for TIE-106			
Prefix-Quadrant-Wall-Circuit-Whip-Index	Type	Total Length	Pull To
HA-2-106-21-2	14/2	26' - 11"	JB2-5

SUMMERSTONE
1550P
 LOT 60
 ELEV-B-LEFT

1 Electrical Side A
 3/8" = 1'-0"

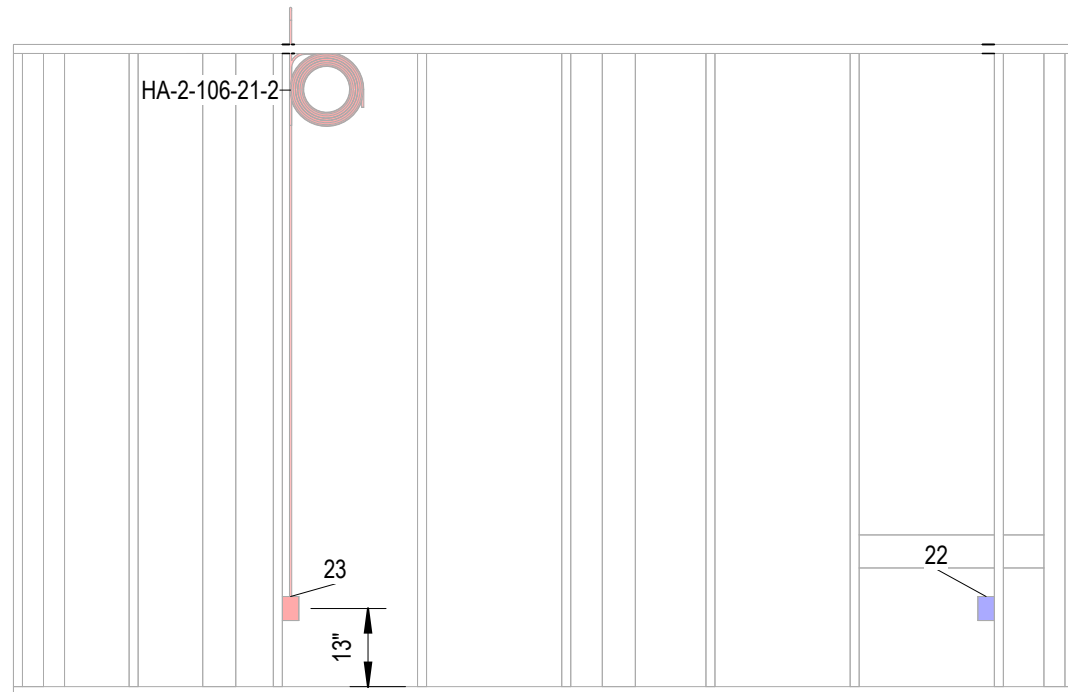

2 Electrical Side B
 3/8" = 1'-0"

11/7/2025 For Review					NOT FOR CONSTRUCTION

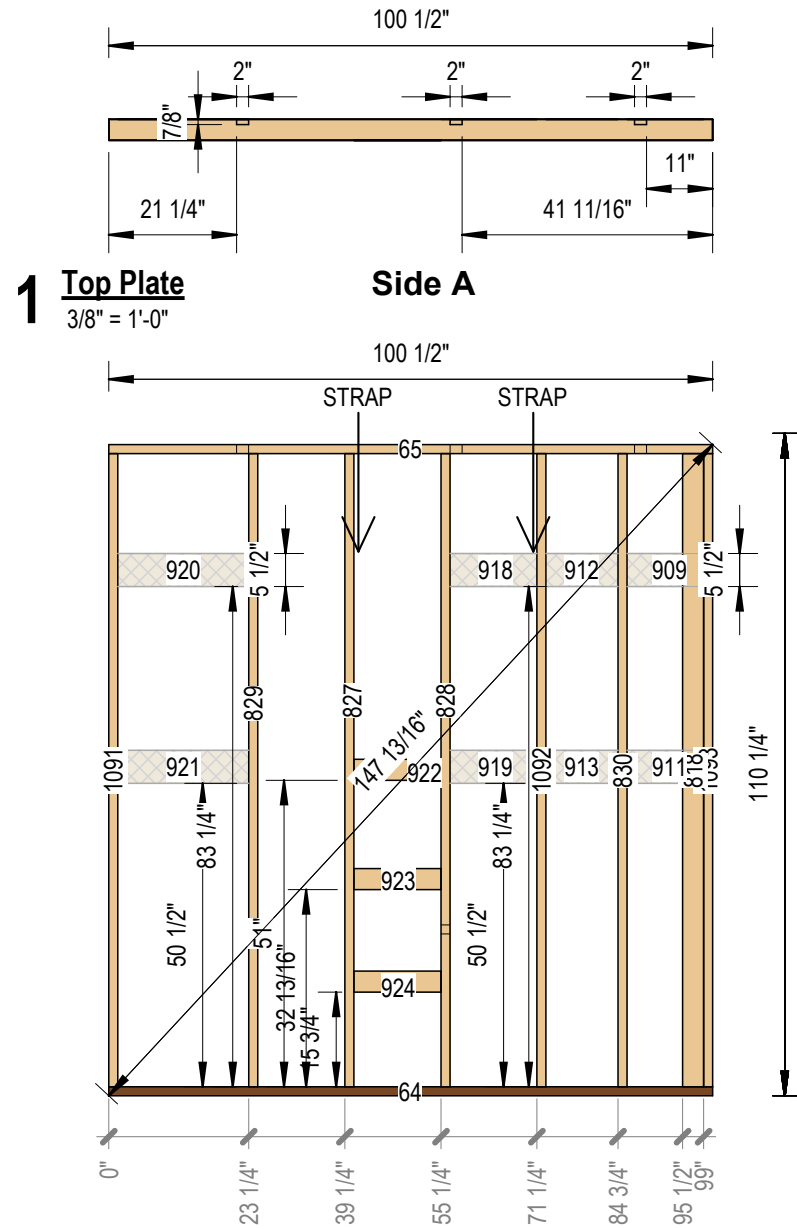

1 Top Plate
3/8" = 1'-0"

Side A

2 Framing Side A
3/8" = 1'-0"

Side A

3 Bottom Plate
3/8" = 1'-0"

Structural Horizontal Framing Schedule

Mark	Piece Type	Description	Structural Material	Side	Cut Length
64	Bottom Plate	2x4	Pressure Treated SPF Standard		100 1/2"
65	Top Plate	2x4	SPF #1/#2		100 1/2"
909 - B	Flat Blocking	2x6	SPF #1/#2	B	12 3/4"
911 - B	Flat Blocking	2x6	SPF #1/#2	B	12 3/4"
912 - B	Flat Blocking	2x6	SPF #1/#2	B	12"
913 - B	Flat Blocking	2x6	SPF #1/#2	B	12"
916 - B	Flat Blocking	2x6	SPF #1/#2	B	14 117/256"
919 - B	Flat Blocking	2x6	SPF #1/#2	B	14 117/256"
920 - B	Flat Blocking	2x6	SPF #1/#2	B	21 203/256"
921 - B	Flat Blocking	2x6	SPF #1/#2	B	21 203/256"
922 - A	Flat Blocking	2x4	SPF #1/#2	A	14 1/2"
923 - A	Flat Blocking	2x4	SPF #1/#2	A	14 1/2"
924 - A	Flat Blocking	2x4	SPF #1/#2	A	14 1/2"

Structural Stud Schedule

Mark	Piece Type	Description	Structural Material	Side	Length
818 - A	FlatStud	2x4	SPF #1/#2	A	105 3/8"
827	Stud	2x4	SPF #1/#2		105 3/8"
828	Stud	2x4	SPF #1/#2		105 3/8"
829	Stud	2x4	SPF #1/#2		105 3/8"
830	Stud	2x4	SPF #1/#2		105 3/8"
1091	Stud	2x4	SPF #1/#2		105 3/8"
1092	Stud	2x4	SPF #1/#2		105 3/8"
1093	Stud	2x4	SPF #1/#2		105 3/8"

Structural Connection Schedule

Type	Count	Side
------	-------	------

SUMMERSTONE
1550P
LOT 60
ELEV-B-LEFT

11/7/2025 For Review					NOT FOR CONSTRUCTION

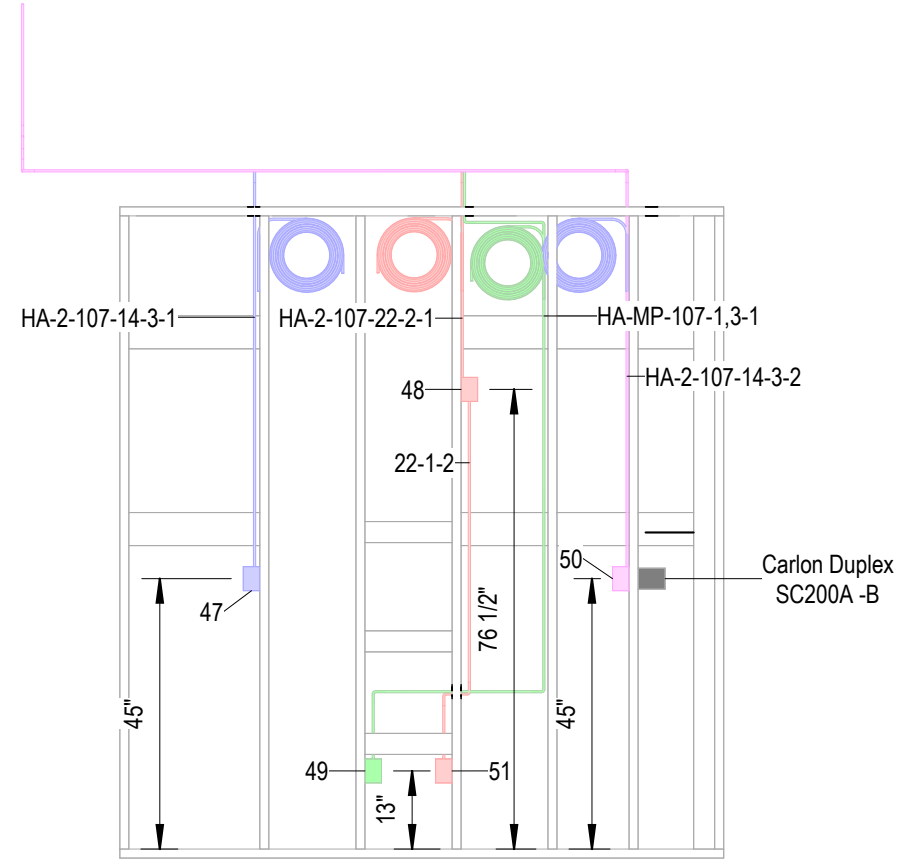

1 Electrical Side A
3/8" = 1'-0"

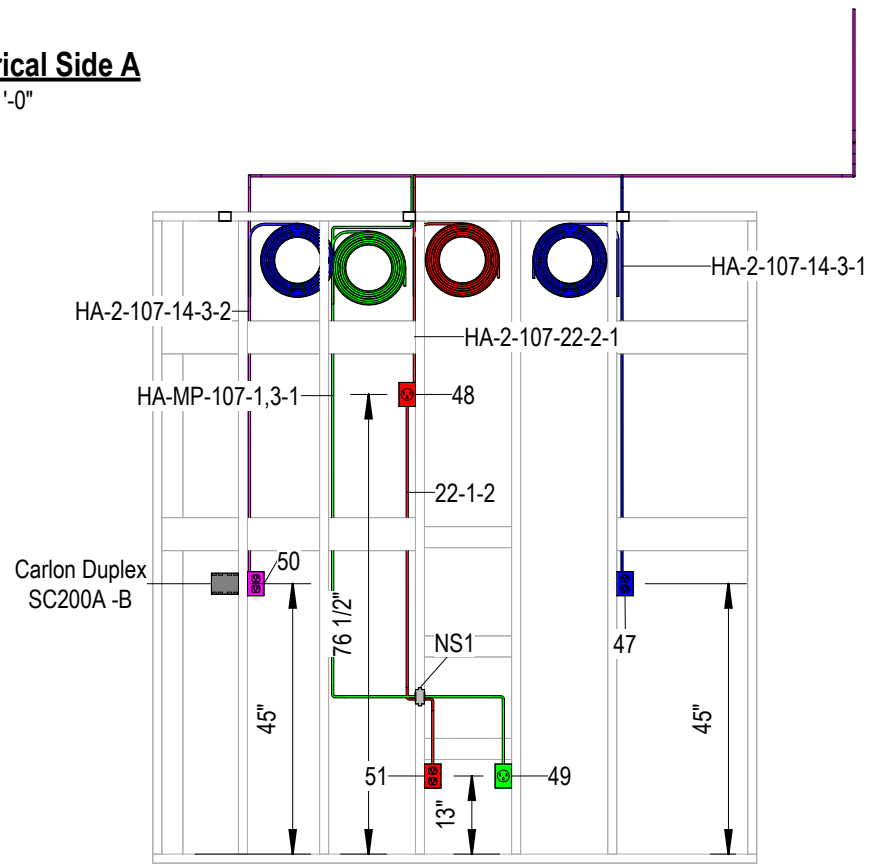

2 Electrical Side B
3/8" = 1'-0"

Electrical Fixture Schedule							
Mark	Side	Box	Device-A	Device-B	Device-C	Device-D	Comments
47	B	EZ18SNW	Receptacle: T5320W				Kitch Counter
48	B	EZ18SNW	Receptacle: T5020WS				Stove Vent
49	B	A52171E	279S00				
50	B	EZ18SNW	Receptacle: T5320W				Kitch Counter
51	B	EZ18SNW	Receptacle: T5320W				

Protection Plate Schedule		
Count	Type	Side
1	NS1	B

Whip for TIPE-107			
Prefix-Quadrant-Wall-Circuit-Whip-Index	Type	Total Length	Pull To
HA-2-107-14-3-1	14/2	18' - 9"	JBA-2.6
HA-2-107-14-3-2	14/2	24' - 0"	JBA-2.6
HA-2-107-16-1	12/2 UF	59' - 5"	JBA-2.2 (Underground: Panel 133, Box 134, Device A)
HA-2-107-16-5	12/2	5' - 10"	JBA-2.2 (Underground: Panel 133, Box 134, Device A)
HA-2-107-22-2-1	<varies>	72' - 1"	JBA-2.3
HA-MP-107-1,3-1	<varies>	80' - 3"	JBA-2.8

SUMMERSTONE
1550P
LOT 60
ELEV-B-LEFT

11/7/2025	For Review	NOT FOR CONSTRUCTION
-----------	------------	-----------------------------

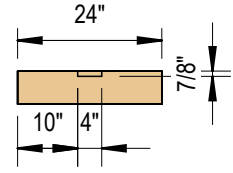

1 Top Plate
3/8" = 1'-0"

Side A

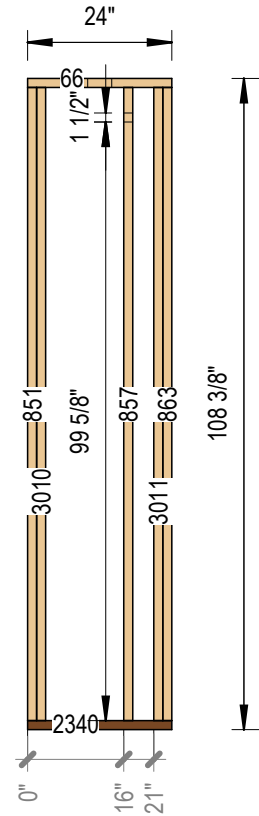

2 Framing Side A
3/8" = 1'-0"

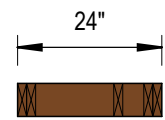

Side A

3 Bottom Plate
3/8" = 1'-0"

Structural Horizontal Framing Schedule

Mark	Piece Type	Description	Structural Material	Side	Cut Length
66	Top Plate	2x6	SPF #1/#2		24"
2340	Bottom Plate	2x6	Pressure Treated SPF Standard		24"

Structural Stud Schedule

Mark	Piece Type	Description	Structural Material	Side	Length
851	Stud	2x6	SPF #1/#2		105 3/8"
857	Stud	2x6	SPF #1/#2		105 3/8"
863	Stud	2x6	SPF #1/#2		105 3/8"
3010	Stud	2x6	SPF #1/#2		105 3/8"
3011	Stud	2x6	SPF #1/#2		105 3/8"

Structural Connection Schedule

Type	Count	Side
------	-------	------



SUMMERSTONE
1550P
LOT 60
ELEV-B-LEFT

11/7/2025	For Review					NOT FOR CONSTRUCTION

Structural Framing
108.1-TIE

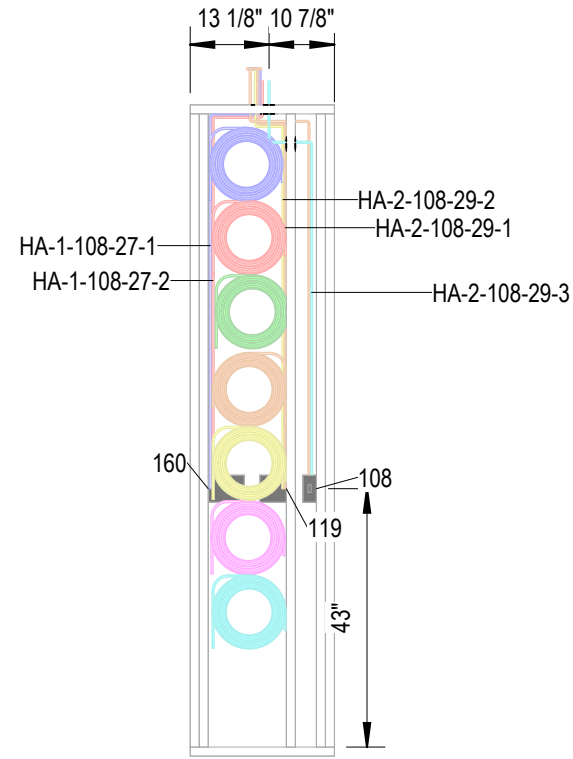

1 Electrical Side A
3/8" = 1'-0"

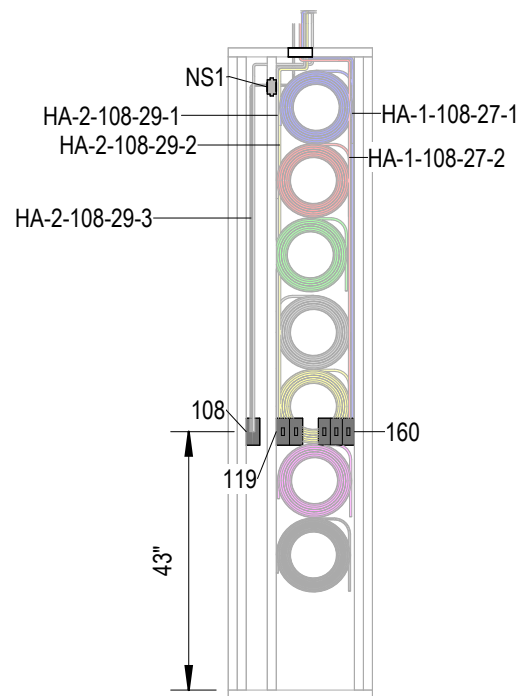

2 Electrical Side B
3/8" = 1'-0"

Electrical Fixture Schedule

Mark	Side	Box	Device-A	Device-B	Device-C	Device-D	Comments
108	B	EZ18SNW	4-Way Switch: 5604-SWS				
119	B	EZ32DN	Standard Switch: 14512W	3-Way Switch: 56032W			
160	B	EZ44TN	Standard Switch: 14512W	Standard Switch: 14512W	Standard Switch: 14512W		

Harness Assembly for TIE-108

Prefix-Quadrant-Wall-Circuit-Whip-Index	Type	Total Length	Pull To
HA-1-108-27-1	14/2	25' - 10"	JB1-4
HA-1-108-27-2	14/3	32' - 1"	Ceiling Box Fan 8
HA-1-108-27-4	14/3	47' - 4"	Panel 108, Box 119, Device B
HA-2-108-29-1	14/2	17' - 3"	JB2-1
HA-2-108-29-2	14/2	20' - 6"	Ceiling Box 59
HA-2-108-29-3	14/3	33' - 5"	Panel 124, Box 109, Device A

Protection Plate Schedule

Count	Type	Side
1	NS1	B



SUMMERSTONE
1550P
LOT 60
ELEV-B-LEFT

11/7/2025	For Review					NOT FOR CONSTRUCTION
-----------	------------	--	--	--	--	-----------------------------

Electrical
108.4-TIE

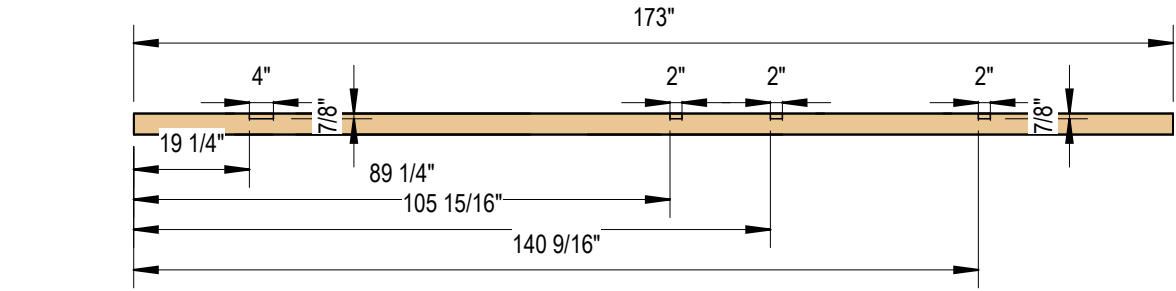

1 Top Plate
3/8" = 1'-0"

Side A

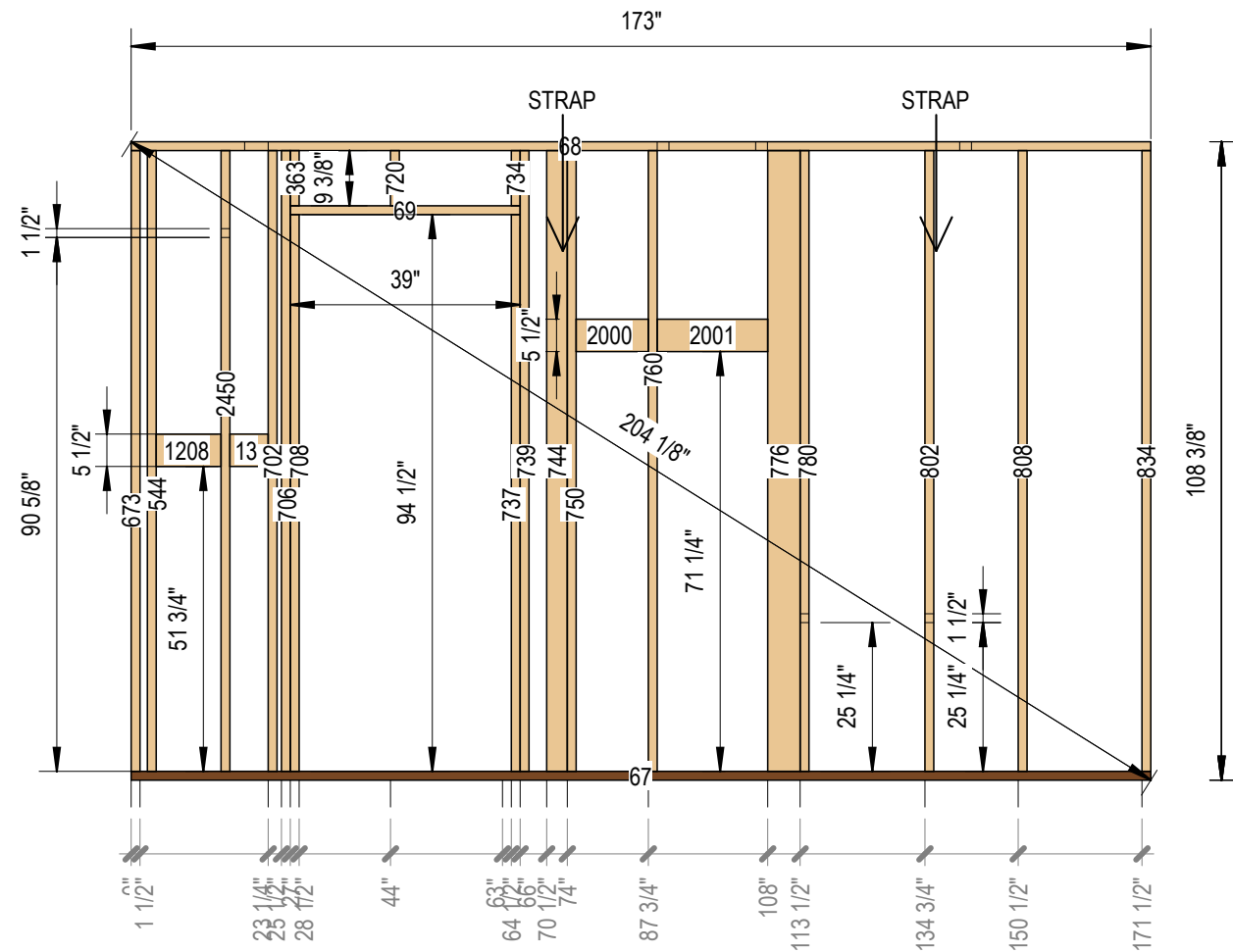

2 Framing Side A
3/8" = 1'-0"

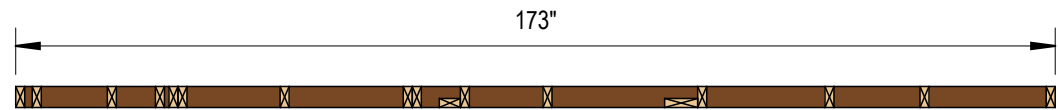

Side A

4 Bottom Plate
3/8" = 1'-0"

Structural Horizontal Framing Schedule					
Mark	Piece Type	Description	Structural Material	Side	Cut Length
13 - A	Flat Blocking	2x6	SPF #1/#2	A	6 1/2"
67	Bottom Plate	2x4	Pressure Treated SPF Standard		173"
68	Top Plate	2x4	SPF #1/#2		173"
69	Header	2x4	SPF #1/#2		39"
1208 - A	Flat Blocking	2x6	SPF #1/#2	A	11"
2000	Flat Blocking	2x6	SPF #1/#2	A	12 1/4"
2001	Flat Blocking	2x6	SPF #1/#2	A	18 3/4"

Structural Stud Schedule					
Mark	Piece Type	Description	Structural Material	Side	Length
363	HeaderCripple	2x4	SPF #1/#2		9 3/8"
544	Stud	2x4	SPF #1/#2		105 3/8"
673	Stud	2x4	SPF #1/#2		105 3/8"
702	Stud	2x4	SPF #1/#2		105 3/8"
706	KingStud	2x4	SPF #1/#2		105 3/8"
708	Trimmer	2x4	SPF #1/#2		94 1/2"
720	HeaderCripple	2x4	SPF #1/#2		9 3/8"
734	HeaderCripple	2x4	SPF #1/#2		9 3/8"
737	Trimmer	2x4	SPF #1/#2		94 1/2"
739	KingStud	2x4	SPF #1/#2		105 3/8"
744 - A	FlatStud	2x4	SPF #1/#2	A	105 3/8"
750	Stud	2x4	SPF #1/#2		105 3/8"
760	Stud	2x4	SPF #1/#2		105 3/8"
776 - A	FlatStud	2x6	SPF #1/#2	A	105 3/8"
780	Stud	2x4	SPF #1/#2		105 3/8"
802	Stud	2x4	SPF #1/#2		105 3/8"
808	Stud	2x4	SPF #1/#2		105 3/8"
834	Stud	2x4	SPF #1/#2		105 3/8"
2450	Stud	2x4	SPF #1/#2		105 3/8"

Structural Connection Schedule		
Type	Count	Side

SUMMERSTONE
1550P
LOT 60
ELEV-B-LEFT

11/7/2025 For Review

NOT FOR CONSTRUCTION

Structural Framing
109.1-TIE

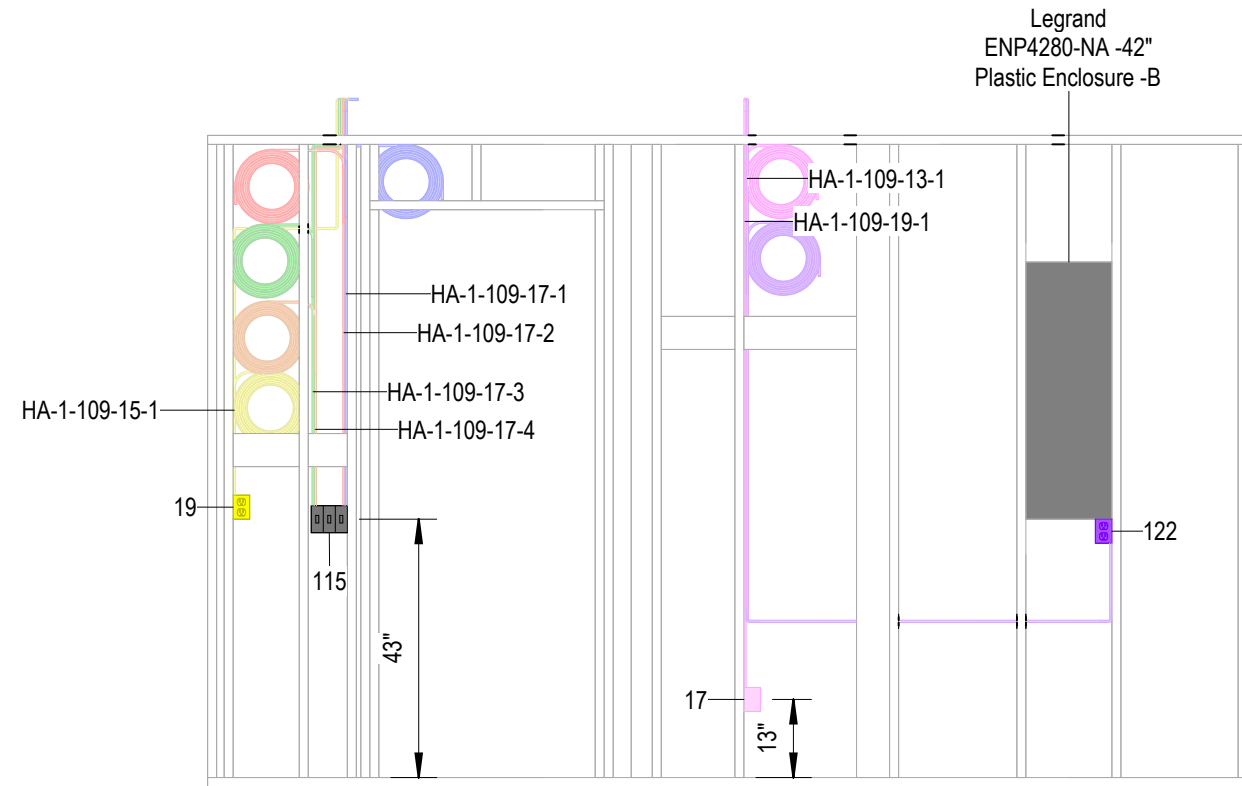

1 Electrical Side A
3/8" = 1'-0"

Electrical Fixture Schedule							
Mark	Side	Box	Device-A	Device-B	Device-C	Device-D	Comments
17	B	EZ18SNW	Receptacle: T5320W				
19	A	EZ18SNW	Receptacle: T5320W				Bath Counter
78	B	ENP4280-NA					
115	A	EZ44TN	Standard Switch: 14512W	Exhaust Fan Switch: 14512W	Standard Switch: 14512W		
122	A	EZ18SNW	Receptacle: T5320W				

Protection Plate Schedule		
Count	Type	Side
2	NS1	B

Harness Assembly for TIE-109			
Prefix-Quadrant-Wall-Circuit-Whip-Index	Type	Total Length	Pull To
HA-1-109-13-1	14/2	26' - 9"	JB1-5
HA-1-109-15-1	12/2	35' - 7"	JB1-1
HA-1-109-17-1	14/2	21' - 8"	JB1-10
HA-1-109-17-2	14/2	14' - 1"	Lighting Fixtures 28-29
HA-1-109-17-3	14/2	20' - 0"	Lighting Fixture 59
HA-1-109-17-4	14/2	17' - 9"	Ceiling Box 199
HA-1-109-19-1	14/2	19' - 9"	JBA-1.8

SUMMERSTONE
1550P
LOT 60
ELEV-B-LEFT

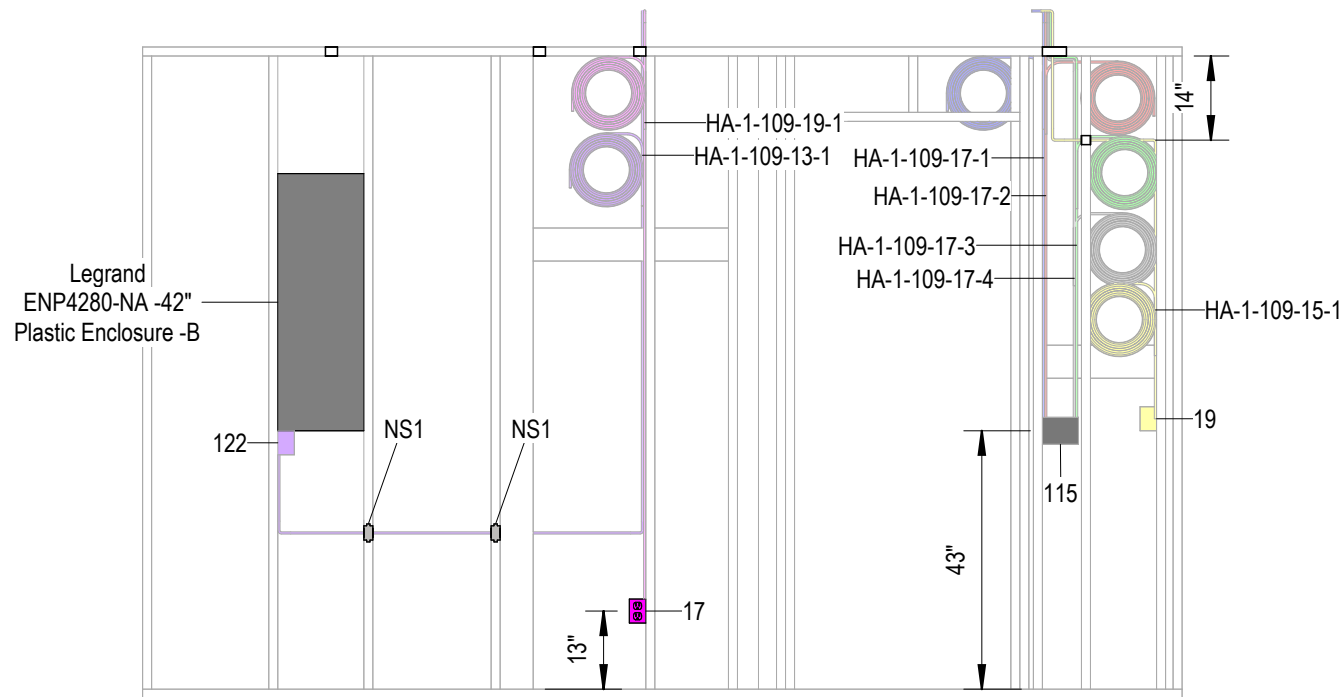

2 Electrical Side B
3/8" = 1'-0"

11/7/2025	For Review	NOT FOR CONSTRUCTION

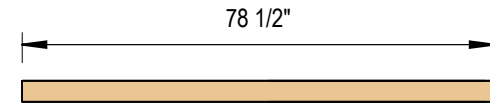

Side A

1 Top Plate
3/8" = 1'-0"

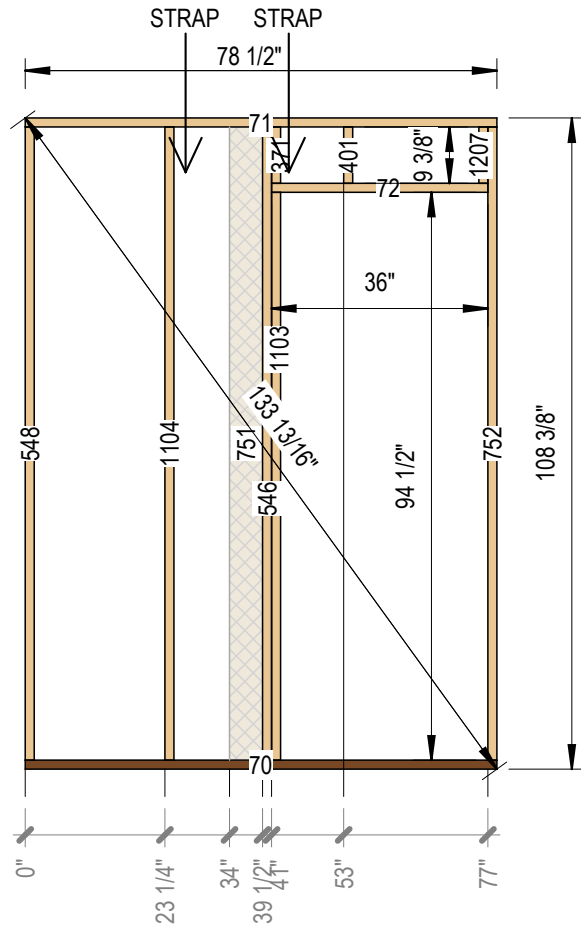

2 Framing Side A
3/8" = 1'-0"



Side A

4 Bottom Plate
3/8" = 1'-0"

Structural Horizontal Framing Schedule

Mark	Piece Type	Description	Structural Material	Side	Cut Length
70	Bottom Plate	2x4	Pressure Treated SPF Standard		78 1/2"
71	Top Plate	2x4	SPF #1/#2		78 1/2"
72	Header	2x4	SPF #1/#2		36"

Structural Stud Schedule

Mark	Piece Type	Description	Structural Material	Side	Length
371	HeaderCripple	2x4	SPF #1/#2		9 3/8"
401	HeaderCripple	2x4	SPF #1/#2		9 3/8"
546	KingStud	2x4	SPF #1/#2		105 3/8"
548	Stud	2x4	SPF #1/#2		105 3/8"
751 - B	FlatStud	2x6	SPF #1/#2	B	105 3/8"
752	Sacrificial	2x4	SPF #1/#2		105 3/8"
1103	Trimmer	2x4	SPF #1/#2		94 1/2"
1104	Stud	2x4	SPF #1/#2		105 3/8"
1207	HeaderCripple	2x4	SPF #1/#2		9 3/8"

Structural Connection Schedule

Type	Count	Side



SUMMERSTONE
1550P
LOT 60
ELEV-B-LEFT

11/7/2025 For Review				NOT FOR CONSTRUCTION

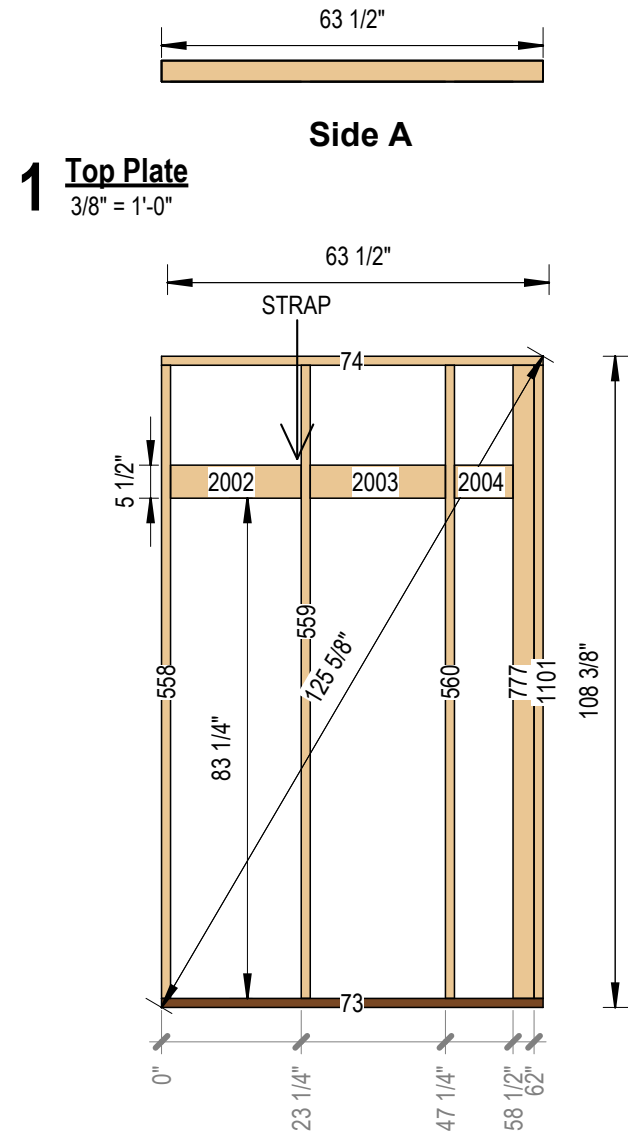

1 Top Plate
3/8" = 1'-0"

2 Framing Side A
3/8" = 1'-0"

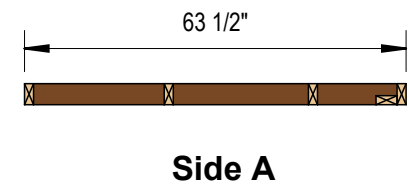

4 Bottom Plate
3/8" = 1'-0"

Structural Horizontal Framing Schedule

Mark	Piece Type	Description	Structural Material	Side	Cut Length
73	Bottom Plate	2x4	Pressure Treated SPF Standard		63 1/2"
74	Top Plate	2x4	SPF #1/#2		63 1/2"
2002	Flat Blocking	2x6	SPF #1/#2	A	21 3/4"
2003	Flat Blocking	2x6	SPF #1/#2	A	22 1/2"
2004	Flat Blocking	2x6	SPF #1/#2	A	9 3/4"

Structural Stud Schedule

Mark	Piece Type	Description	Structural Material	Side	Length
558	Stud	2x4	SPF #1/#2		105 3/8"
559	Stud	2x4	SPF #1/#2		105 3/8"
560	Stud	2x4	SPF #1/#2		105 3/8"
777 - A	FlatStud	2x4	SPF #1/#2	A	105 3/8"
1101	Stud	2x4	SPF #1/#2		105 3/8"

Structural Connection Schedule

Type	Count	Side
------	-------	------

SUMMERSTONE
1550P
LOT 60
ELEV-B-LEFT

11/7/2025 For Review					NOT FOR CONSTRUCTION

1 Top Plate
3/8" = 1'-0"

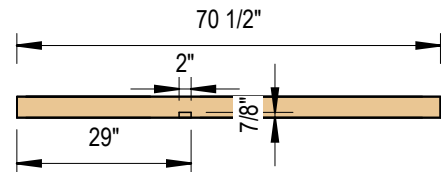

Side A

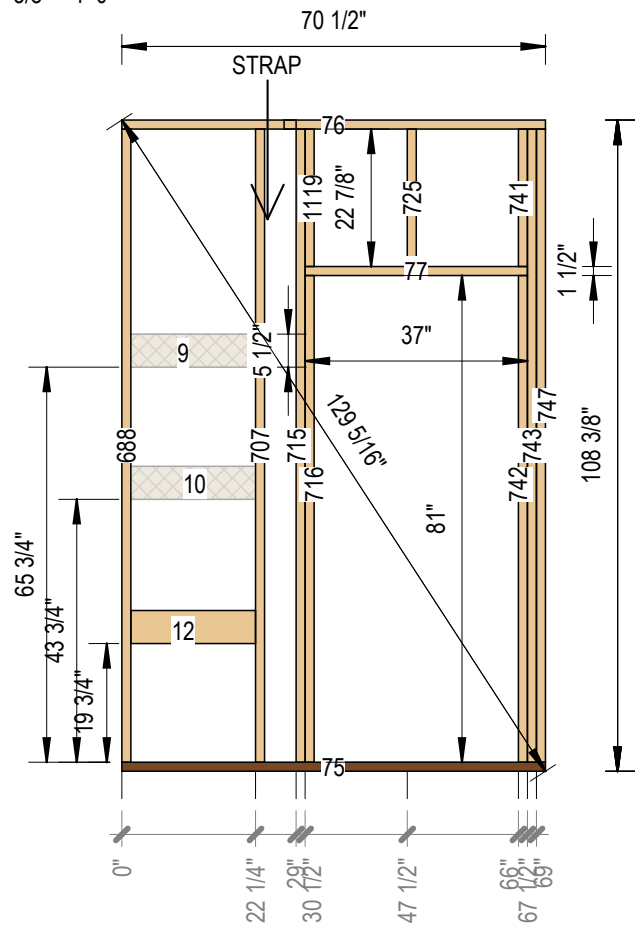

2 Framing Side A
3/8" = 1'-0"

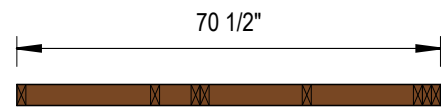

Side A

3 Bottom Plate
3/8" = 1'-0"

Structural Horizontal Framing Schedule

Mark	Piece Type	Description	Structural Material	Side	Cut Length
9 - B	Flat Blocking	2x6	SPF #1/#2	B	20 3/4"
10 - B	Flat Blocking	2x6	SPF #1/#2	B	20 3/4"
12 - A	Flat Blocking	2x6	SPF #1/#2	A	20 3/4"
75	Bottom Plate	2x4	Pressure Treated SPF Standard		70 1/2"
76	Top Plate	2x4	SPF #1/#2		70 1/2"
77	Header	2x4	SPF #1/#2		37"

Structural Stud Schedule

Mark	Piece Type	Description	Structural Material	Side	Length
688	Stud	2x4	SPF #1/#2		105 3/8"
707	Stud	2x4	SPF #1/#2		105 3/8"
715	KingStud	2x4	SPF #1/#2		105 3/8"
716	Trimmer	2x4	SPF #1/#2		81"
725	HeaderCripple	2x4	SPF #1/#2		22 7/8"
741	HeaderCripple	2x4	SPF #1/#2		22 7/8"
742	Trimmer	2x4	SPF #1/#2		81"
743	Trimmer	2x4	SPF #1/#2		105 3/8"
747	Stud	2x4	SPF #1/#2		105 3/8"
1119	HeaderCripple	2x4	SPF #1/#2		22 7/8"

Structural Connection Schedule

Type	Count	Side
------	-------	------

11/7/2025 For Review				NOT FOR CONSTRUCTION

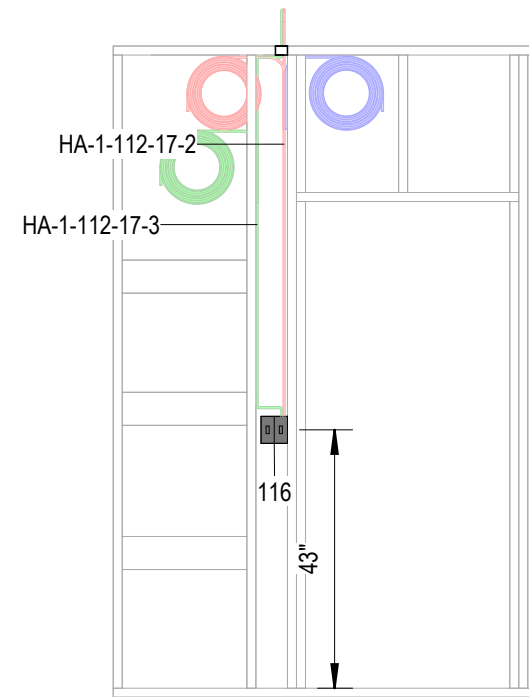

1 Electrical Side A
3/8" = 1'-0"

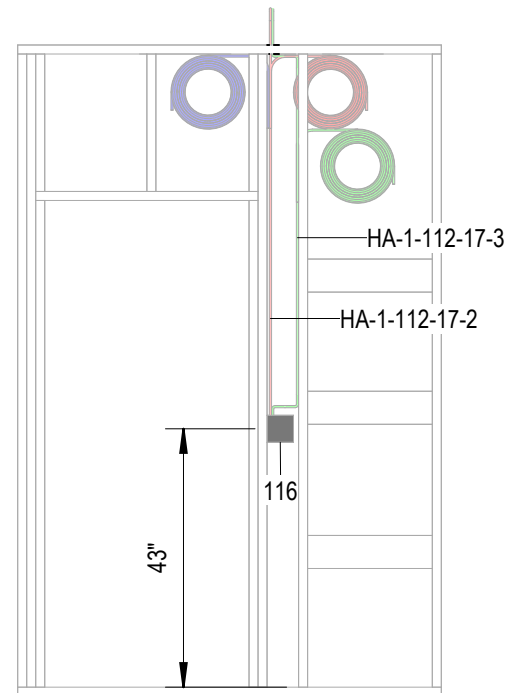

2 Electrical Side B
3/8" = 1'-0"

Electrical Fixture Schedule							
Mark	Side	Box	Device-A	Device-B	Device-C	Device-D	Comments
116	A	EZ32DN	Standard Switch: 14512W	Fan Switch: 14512W			

Protection Plate Schedule		
Count	Type	Side

Harness Assembly for TIE-112			
Prefix-Quadrant-Wall-Circuit-Whip-Index	Type	Total Length	Pull To
HA-1-112-17-1	14/2	29' - 8"	JB1-10
HA-1-112-17-2	14/2	12' - 0"	Lighting Fixture 11
HA-1-112-17-3	14/2	13' - 11"	Ceiling Box 200

SUMMERSTONE
1550P
LOT 60
ELEV-B-LEFT

11/7/2025	For Review						NOT FOR CONSTRUCTION
-----------	------------	--	--	--	--	--	-----------------------------

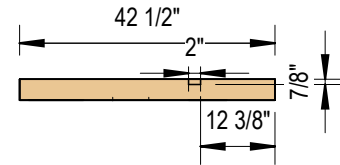

Side A

1 Top Plate
3/8" = 1'-0"

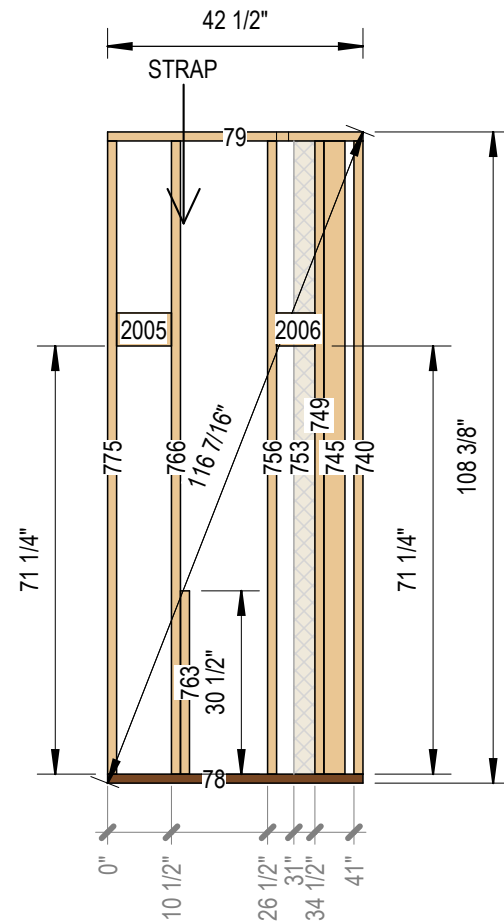

2 Framing Side A
3/8" = 1'-0"

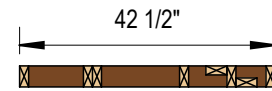

Side A

4 Bottom Plate
3/8" = 1'-0"

Structural Horizontal Framing Schedule

Mark	Piece Type	Description	Structural Material	Side	Cut Length
78	Bottom Plate	2x4	Pressure Treated SPF Standard		42 1/2"
79	Top Plate	2x4	SPF #1/#2		42 1/2"
2005	Flat Blocking	2x6	SPF #1/#2	A	9 1/8"
2006	Flat Blocking	2x6	SPF #1/#2	A	6 3/8"

Structural Stud Schedule

Mark	Piece Type	Description	Structural Material	Side	Length
740	Stud	2x4	SPF #1/#2		105 3/8"
745 - A	FlatStud	2x4	SPF #1/#2	A	105 3/8"
749	Stud	2x4	SPF #1/#2		105 3/8"
753 - B	FlatStud	2x4	SPF #1/#2	B	105 3/8"
756	Stud	2x4	SPF #1/#2		105 3/8"
763	Stud	2x4	SPF #1/#2		30 1/2"
766	Stud	2x4	SPF #1/#2		105 3/8"
775	Stud	2x4	SPF #1/#2		105 3/8"

Structural Connection Schedule

Type	Count	Side
------	-------	------



SUMMERSTONE
1550P
LOT 60
ELEV-B-LEFT

11/7/2025 For Review				NOT FOR CONSTRUCTION

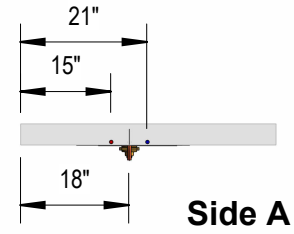

1 Top Plumbing View
3/8" = 1'-0"

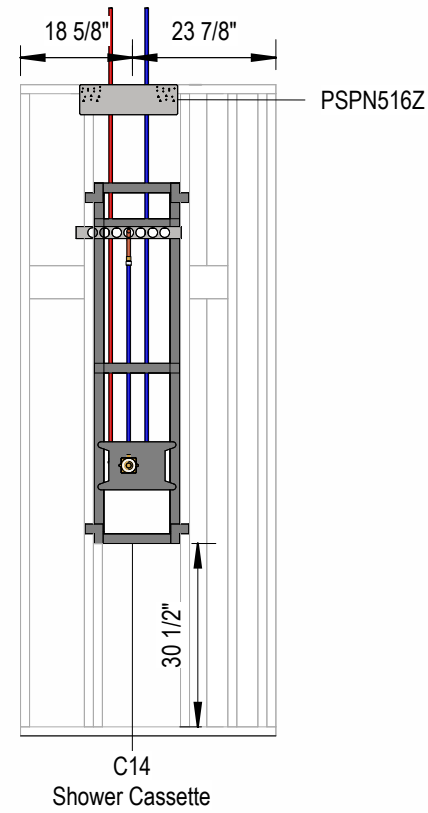

2 Plumbing Side A
3/8" = 1'-0"

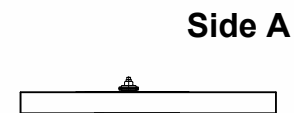

3 Bottom Plumbing View
3/8" = 1'-0"

Plumbing Fixtures Schedule		
Cassette ID	Type	.Side
C14	Shower Cassette	A

Protection Plate schedule		
Count	Type	Side
1	PSPN516Z	A



SUMMERSTONE
1550P
LOT 60
ELEV-B-LEFT

11/7/2025	For Review						NOT FOR CONSTRUCTION
-----------	------------	--	--	--	--	--	-----------------------------

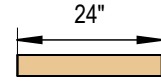

1 Top Plate
3/8" = 1'-0"

Side A

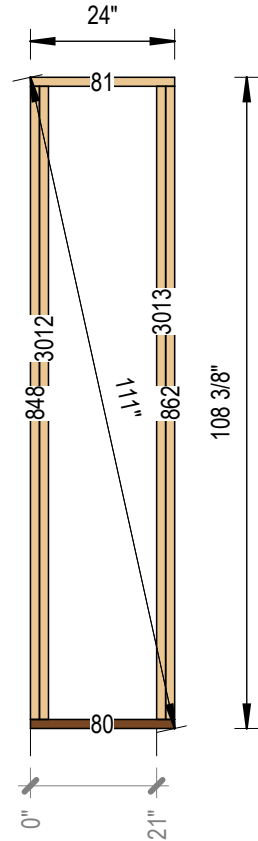

2 Framing Side A
3/8" = 1'-0"

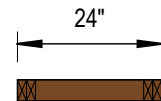

Side A

3 Bottom Plate
3/8" = 1'-0"

Structural Horizontal Framing Schedule

Mark	Piece Type	Description	Structural Material	Side	Cut Length
80	Bottom Plate	2x4	Pressure Treated SPF Standard		24"
81	Top Plate	2x4	SPF #1/#2		24"

Structural Stud Schedule

Mark	Piece Type	Description	Structural Material	Side	Length
848	Stud	2x4	SPF #1/#2		105 3/8"
862	Stud	2x4	SPF #1/#2		105 3/8"
3012	Stud	2x4	SPF #1/#2		105 3/8"
3013	Stud	2x4	SPF #1/#2		105 3/8"

Structural Connection Schedule

Type	Count	Side
------	-------	------



SUMMERSTONE
1550P
LOT 60
ELEV-B-LEFT

11/7/2025 For Review					NOT FOR CONSTRUCTION

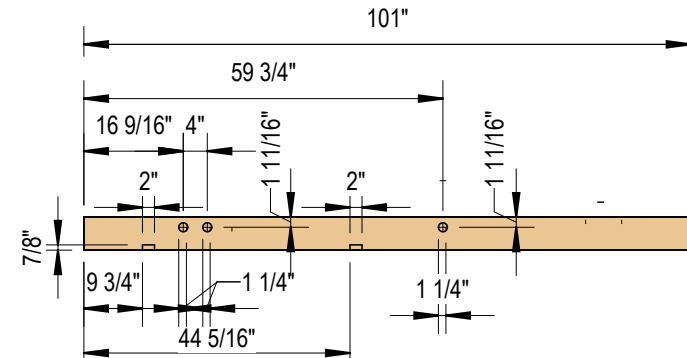

1 Top Plate
3/8" = 1'-0"

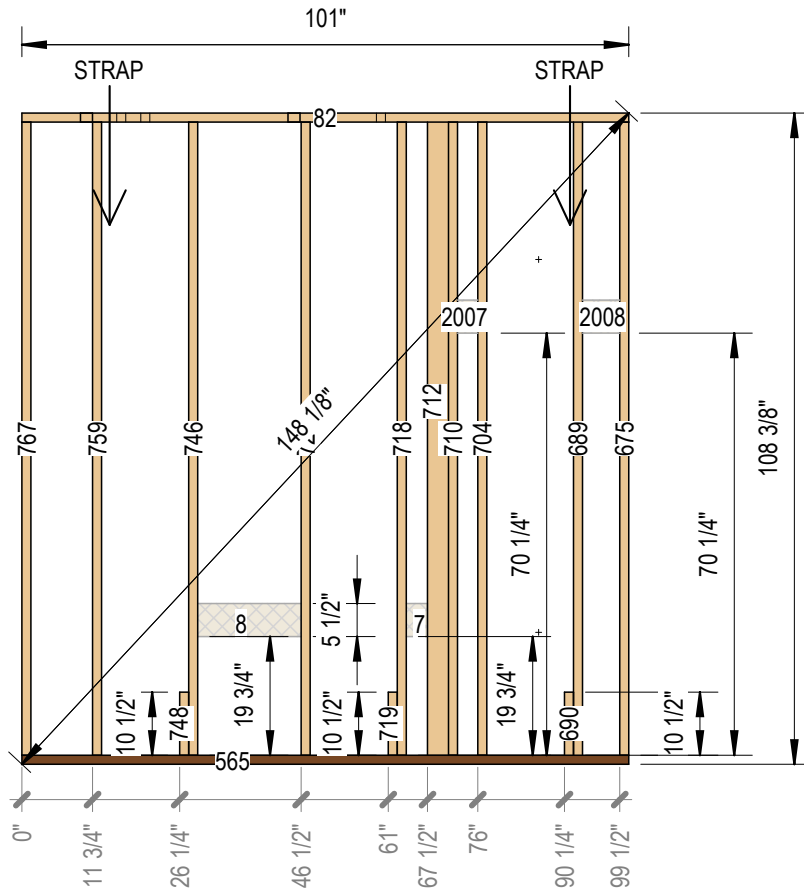

2 Framing Side A
3/8" = 1'-0"

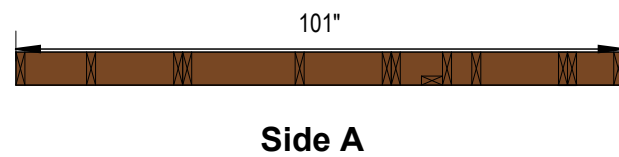

3 Bottom Plate
3/8" = 1'-0"

Structural Horizontal Framing Schedule

Mark	Piece Type	Description	Structural Material	Side	Cut Length
7 - B	Flat Blocking	2x6	SPF #1/#2	B	3 135/256"
8 - B	Flat Blocking	2x6	SPF #1/#2	B	17 55/256"
82	Top Plate	2x6	SPF #1/#2		101"
565	Bottom Plate	2x6	Pressure Treated SPF Standard		101"
2007	Flat Blocking	2x6	SPF #1/#2	B	3 3/8"
2008	Flat Blocking	2x6	SPF #1/#2	B	6 51/256"

Structural Stud Schedule

Mark	Piece Type	Description	Structural Material	Side	Length
675	Stud	2x6	SPF #1/#2		105 3/8"
689	Stud	2x6	SPF #1/#2		105 3/8"
690	Stud	2x6	SPF #1/#2		10 1/2"
704	Stud	2x6	SPF #1/#2		105 3/8"
710	Stud	2x6	SPF #1/#2		105 3/8"
712	Stud	2x4	SPF #1/#2		105 3/8"
718	Stud	2x6	SPF #1/#2		105 3/8"
719	Stud	2x6	SPF #1/#2		10 1/2"
726	Stud	2x6	SPF #1/#2		105 3/8"
746	Stud	2x6	SPF #1/#2		105 3/8"
748	Stud	2x6	SPF #1/#2		10 1/2"
759	Stud	2x6	SPF #1/#2		105 3/8"
767	Stud	2x6	SPF #1/#2		105 3/8"

Structural Connection Schedule

Type	Count	Side
------	-------	------

11/7/2025 For Review				NOT FOR CONSTRUCTION

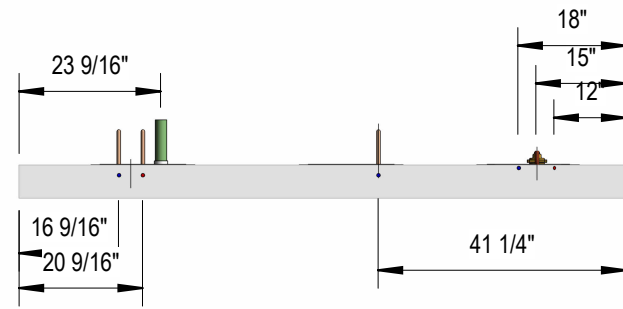

1 Top Plumbing View
3/8" = 1'-0"

Side A

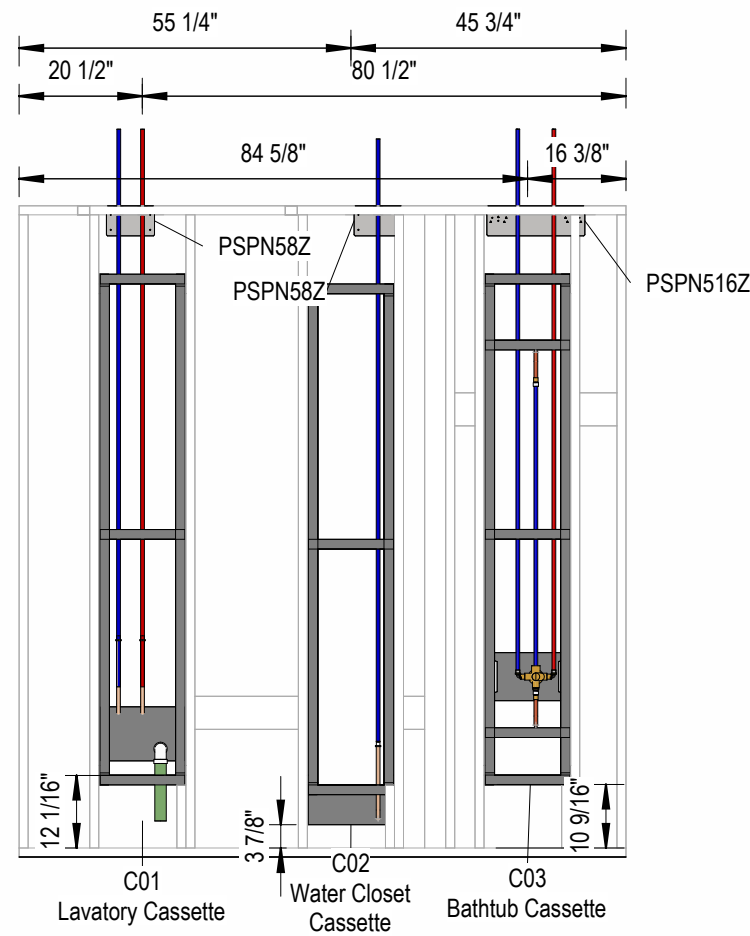

2 Plumbing Side A
3/8" = 1'-0"

Side A

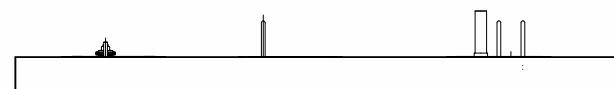

3 Bottom Plumbing View
3/8" = 1'-0"

Plumbing Fixtures Schedule		
Cassette ID	Type	.Side
C03	Bathtub Cassette	A
C02	Water Closet Cassette	A
C01	Lavatory Cassette	A

Protection Plate schedule		
Count	Type	Side
2	PSPN58Z	B
1	PSPN516Z	B



SUMMERSTONE
1550P
LOT 60
ELEV-B-LEFT

11/7/2025 For Review				NOT FOR CONSTRUCTION

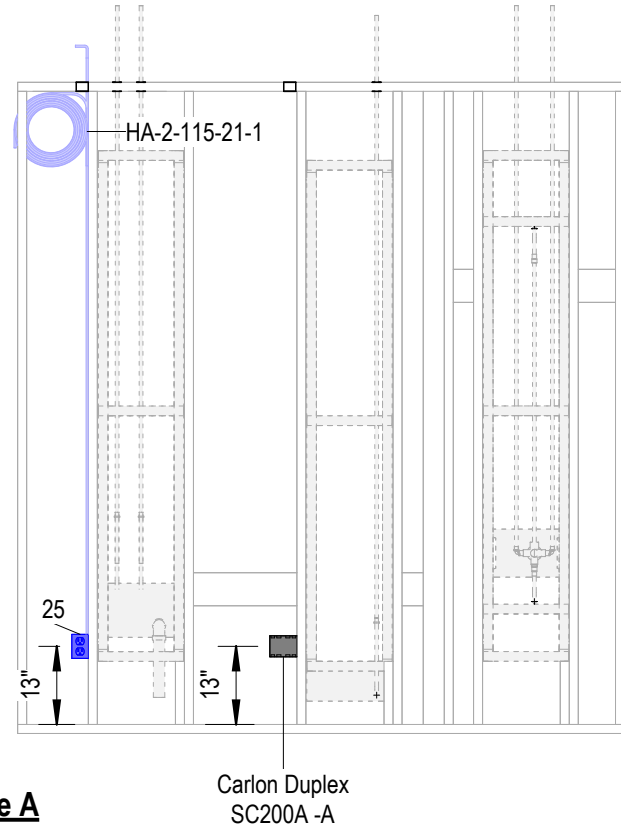

Electrical Fixture Schedule							
Mark	Side	Box	Device-A	Device-B	Device-C	Device-D	Comments
25	A	EZ18SNW	Receptacle: T5320W				

Protection Plate Schedule		
Count	Type	Side

Harness Assembly for TIPE-115			
Prefix-Quadrant-Wall-Circuit-Whip-Index	Type	Total Length	Pull To
HA-2-115-21-1	14/2	21' - 1"	JB2-5

1 Electrical Side A
3/8" = 1'-0"

Carlton Duplex
SC200A -A

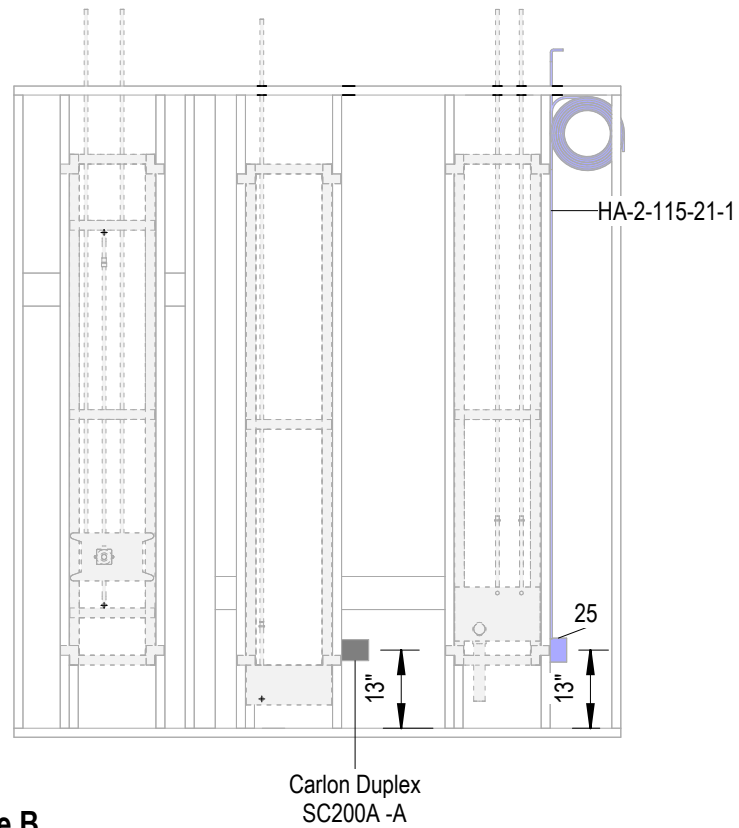

2 Electrical Side B
3/8" = 1'-0"

Carlton Duplex
SC200A -A

SUMMERSTONE
1550P
LOT 60
ELEV-B-LEFT

11/7/2025	For Review	NOT FOR CONSTRUCTION

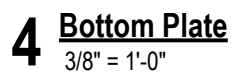
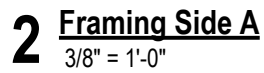
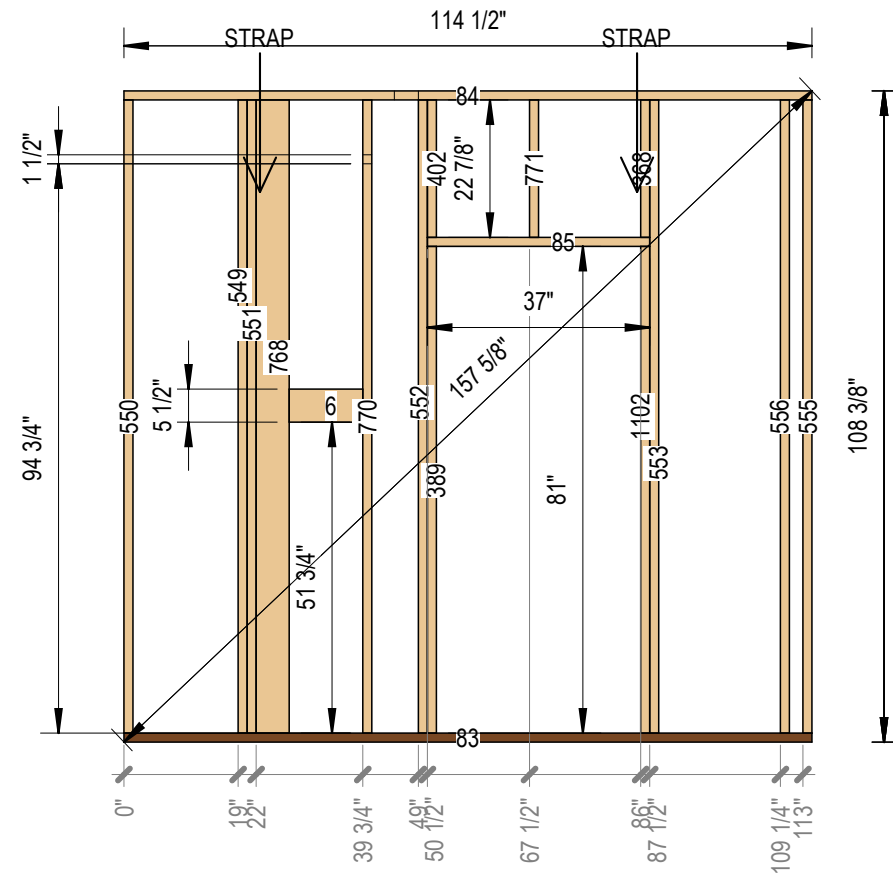
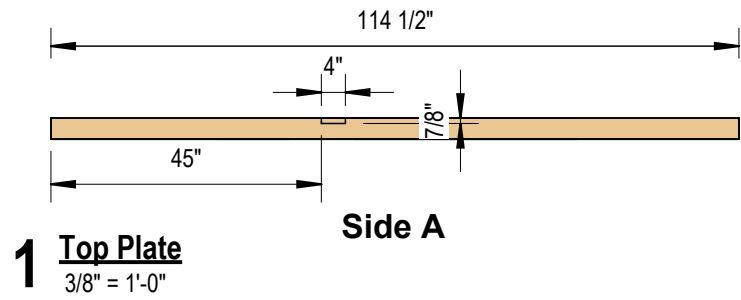

Structural Horizontal Framing Schedule

Mark	Piece Type	Description	Structural Material	Side	Cut Length
6 - A	Flat Blocking	2x6	SPF #1/#2	A	12 1/4"
83	Bottom Plate	2x4	Pressure Treated SPF Standard		114 1/2"
84	Top Plate	2x4	SPF #1/#2		114 1/2"
85	Header	2x4	SPF #1/#2		37"

Structural Stud Schedule

Mark	Piece Type	Description	Structural Material	Side	Length
368	HeaderCripple	2x4	SPF #1/#2		22 7/8"
389	Trimmer	2x4	SPF #1/#2		81"
402	HeaderCripple	2x4	SPF #1/#2		22 7/8"
549	Stud	2x4	SPF #1/#2		105 3/8"
550	Stud	2x4	SPF #1/#2		105 3/8"
551	Stud	2x4	SPF #1/#2		105 3/8"
552	KingStud	2x4	SPF #1/#2		105 3/8"
553	KingStud	2x4	SPF #1/#2		105 3/8"
555	Stud	2x4	SPF #1/#2		105 3/8"
556	Stud	2x4	SPF #1/#2		105 3/8"
768 - A	FlatStud	2x6	SPF #1/#2	A	105 3/8"
770	Stud	2x4	SPF #1/#2		105 3/8"
771	HeaderCripple	2x4	SPF #1/#2		22 7/8"
1102	Trimmer	2x4	SPF #1/#2		81"

Structural Connection Schedule

Type	Count	Side
------	-------	------

11/7/2025	For Review	NOT FOR CONSTRUCTION
-----------	------------	----------------------

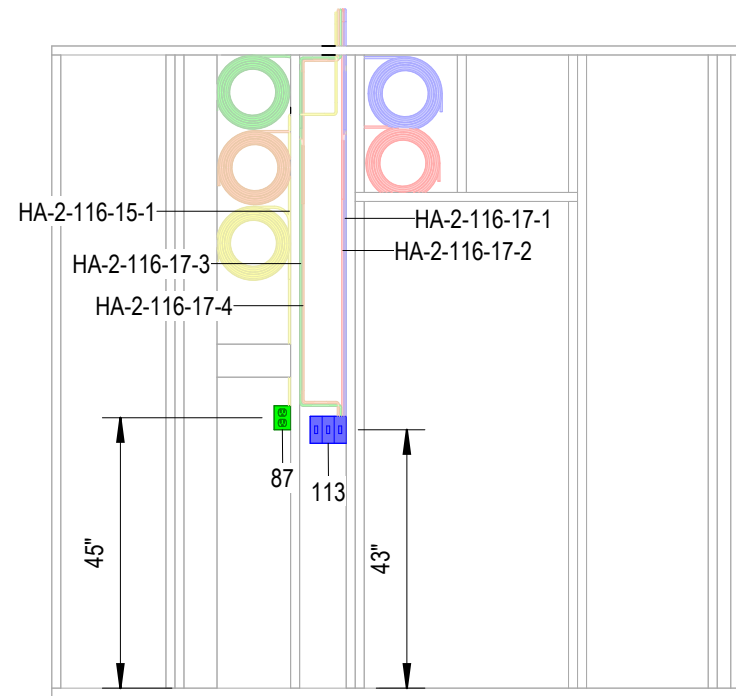

Electrical Fixture Schedule							
Mark	Side	Box	Device-A	Device-B	Device-C	Device-D	Comments
87	A	EZ18SNW	Receptacle: T5320W				Bath Counter
113	A	EZ44TN	Standard Switch: 14512W	Standard Switch: 14512W	Exhaust Fan Switch: 14512W		

Protection Plate Schedule		
Count	Type	Side
1	NS1	B

Harness Assembly for TIE-116			
Prefix-Quadrant-Wall-Circuit-Whip-Index	Type	Total Length	Pull To
HA-2-116-15-1	12/2	28' - 11"	JB2-4
HA-2-116-17-1	14/2	30' - 1"	JB2-9
HA-2-116-17-2	14/2	12' - 1"	Light Fixture 34
HA-2-116-17-3	14/2	18' - 8"	Light Fixture 60
HA-2-116-17-4	14/2	16' - 4"	Exhaust Fan 198

SUMMERSTONE
1550P
 LOT 60
 ELEV-B-LEFT

1 Electrical Side A
 3/8" = 1'-0"

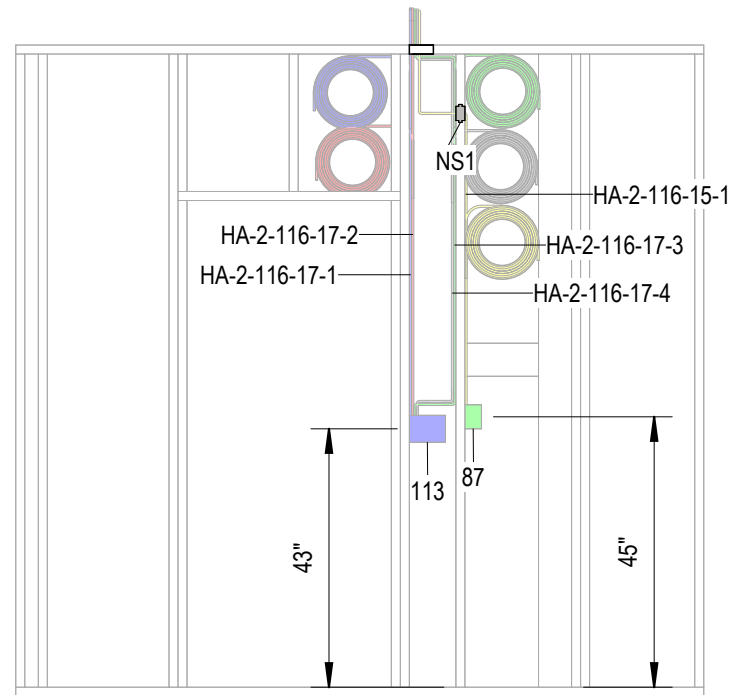

2 Electrical Side B
 3/8" = 1'-0"

11/7/2025	For Review					NOT FOR CONSTRUCTION
-----------	------------	--	--	--	--	-----------------------------

1 Top Plate
3/8" = 1'-0"

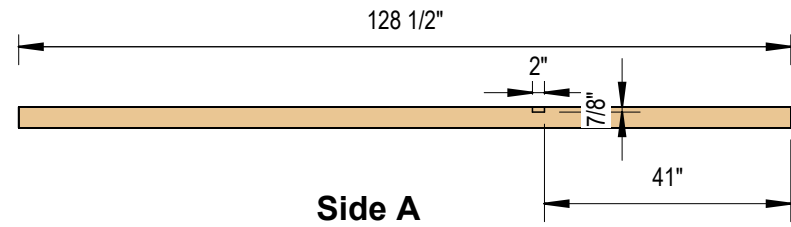

2 Framing Side A
3/8" = 1'-0"

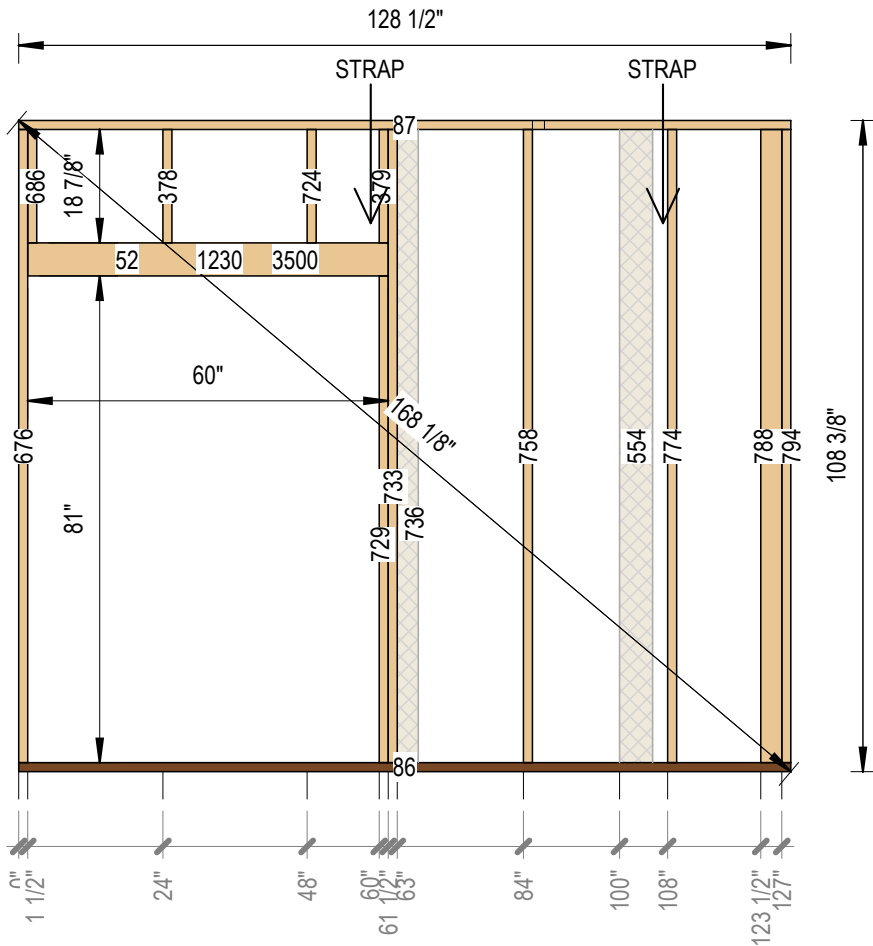

4 Bottom Plate
3/8" = 1'-0"

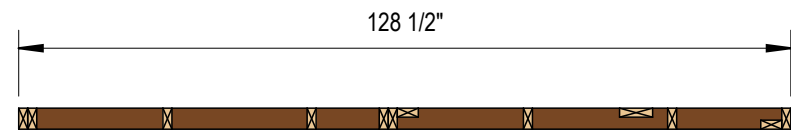

Structural Horizontal Framing Schedule

Mark	Piece Type	Description	Structural Material	Side	Cut Length
52	Header	15/32"x5.5"	15/32" APA-Rated OSB		60"
86	Bottom Plate	2x4	Pressure Treated SPF Standard		128 1/2"
87	Top Plate	2x4	SPF #1/#2		128 1/2"
1230	Header	2x6	SPF #1/#2		60"
3500	Header	2x6	SPF #1/#2		60"

Structural Stud Schedule

Mark	Piece Type	Description	Structural Material	Side	Length
378	HeaderCripple	2x4	SPF #1/#2		18 7/8"
379	HeaderCripple	2x4	SPF #1/#2		18 7/8"
554 - B	FlatStud	2x6	SPF #1/#2	B	105 3/8"
676	KingStud	2x4	SPF #1/#2		105 3/8"
686	HeaderCripple	2x4	SPF #1/#2		18 7/8"
724	HeaderCripple	2x4	SPF #1/#2		18 7/8"
729	KingStud	2x4	SPF #1/#2		81"
733	KingStud	2x4	SPF #1/#2		105 3/8"
736 - B	FlatStud	2x4	SPF #1/#2	B	105 3/8"
758	KingStud	2x4	SPF #1/#2		105 3/8"
774	KingStud	2x4	SPF #1/#2		105 3/8"
788 - A	FlatStud	2x4	SPF #1/#2	A	105 3/8"
794	KingStud	2x4	SPF #1/#2		105 3/8"

Structural Connection Schedule

Type	Count	Side
------	-------	------

11/7/2025 For Review					NOT FOR CONSTRUCTION
----------------------	--	--	--	--	-----------------------------

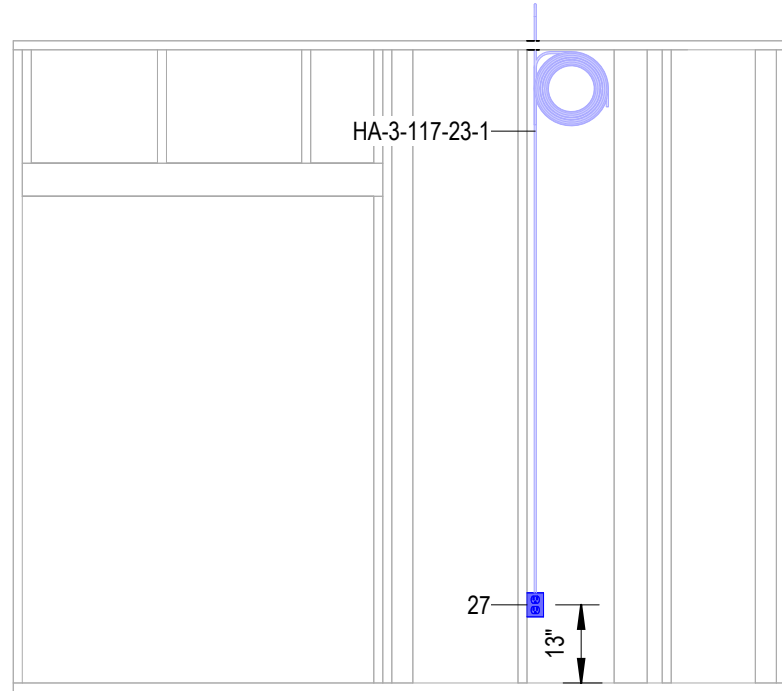

Electrical Fixture Schedule							
Mark	Side	Box	Device-A	Device-B	Device-C	Device-D	Comments
27	A	EZ18SNW	Receptacle: T5320W				

Protection Plate Schedule		
Count	Type	Side

Harness Assembly for TIE-117			
Prefix-Quadrant-Wall-Circuit-Whip-Index	Type	Total Length	Pull To
HA-3-117-23-1	14/2	31' - 3"	JB3-7

1 Electrical Side A
3/8" = 1'-0"

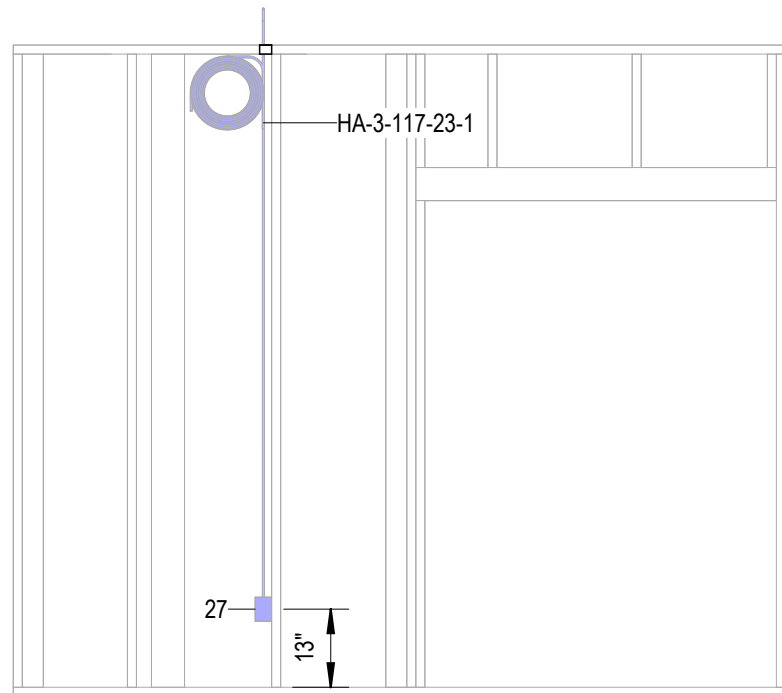

2 Electrical Side B
3/8" = 1'-0"

SUMMERSTONE
1550P
LOT 60
ELEV-B-LEFT

11/7/2025	For Review							NOT FOR CONSTRUCTION
-----------	------------	--	--	--	--	--	--	-----------------------------

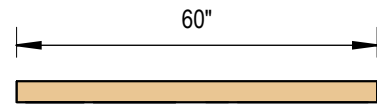

Side A

1 Top Plate
3/8" = 1'-0"

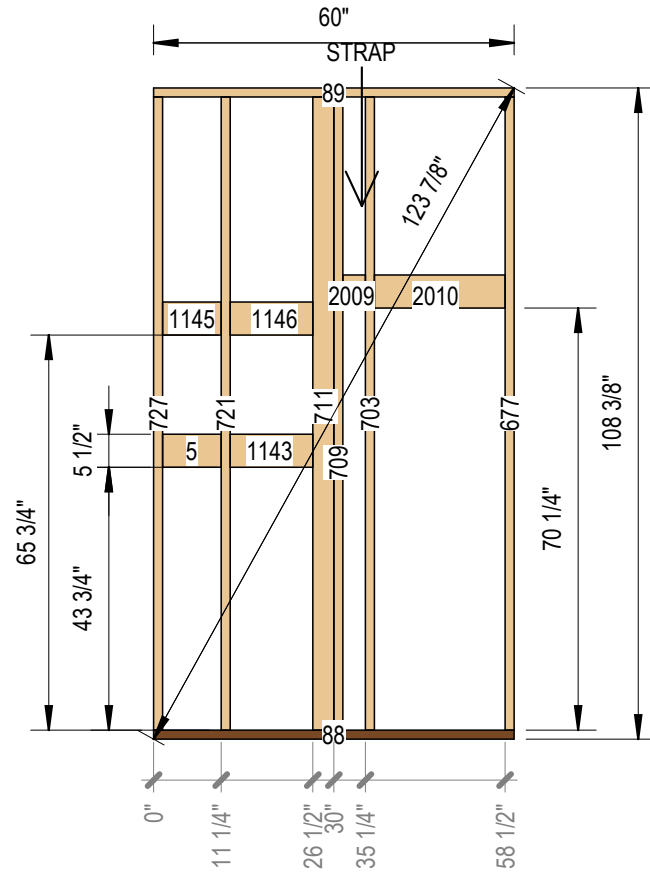

2 Framing Side A
3/8" = 1'-0"



Side A

4 Bottom Plate
3/8" = 1'-0"

Structural Horizontal Framing Schedule

Mark	Piece Type	Description	Structural Material	Side	Cut Length
5 - A	Flat Blocking	2x6	SPF #1/#2	A	9 193/256"
88	Bottom Plate	2x4	Pressure Treated SPF Standard		60"
89	Top Plate	2x4	SPF #1/#2		60"
1143 - A	Flat Blocking	2x6	SPF #1/#2	A	13 191/256"
1145 - A	Flat Blocking	2x6	SPF #1/#2	A	9 193/256"
1146 - A	Flat Blocking	2x6	SPF #1/#2	A	13 191/256"
2009	Flat Blocking	2x6	SPF #1/#2	A	3 3/4"
2010	Flat Blocking	2x6	SPF #1/#2	A	21 3/4"

Structural Stud Schedule

Mark	Piece Type	Description	Structural Material	Side	Length
677	Stud	2x4	SPF #1/#2		105 3/8"
703	Stud	2x4	SPF #1/#2		105 3/8"
709	Stud	2x4	SPF #1/#2		105 3/8"
711 - A	FlatStud	2x4	SPF #1/#2	A	105 3/8"
721	Stud	2x4	SPF #1/#2		105 3/8"
727	Stud	2x4	SPF #1/#2		105 3/8"

Structural Connection Schedule

Type	Count	Side
------	-------	------



SUMMERSTONE
1550P
LOT 60
ELEV-B-LEFT

11/7/2025 For Review					NOT FOR CONSTRUCTION

Structural Framing
118.1-TIS

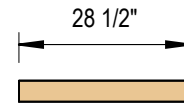

Side A

1 Top Plate
3/8" = 1'-0"

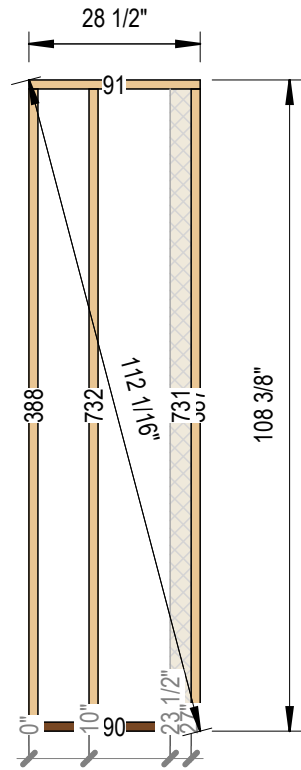

2 Framing Side A
3/8" = 1'-0"

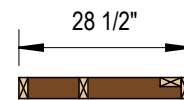

Side A

4 Bottom Plate
3/8" = 1'-0"

Structural Horizontal Framing Schedule

Mark	Piece Type	Description	Structural Material	Side	Cut Length
90	Bottom Plate	2x4	Pressure Treated SPF Standard		28 1/2"
91	Top Plate	2x4	SPF #1/#2		28 1/2"

Structural Stud Schedule

Mark	Piece Type	Description	Structural Material	Side	Length
387	Stud	2x4	SPF #1/#2		105 3/8"
388	Stud	2x4	SPF #1/#2		105 3/8"
731 - B	FlatStud	2x4	SPF #1/#2	B	105 3/8"
732	Stud	2x4	SPF #1/#2		105 3/8"

Structural Connection Schedule

Type	Count	Side
------	-------	------



SUMMERSTONE
1550P
LOT 60
ELEV-B-LEFT

11/7/2025 For Review					NOT FOR CONSTRUCTION

Structural Framing
119.1-TIS

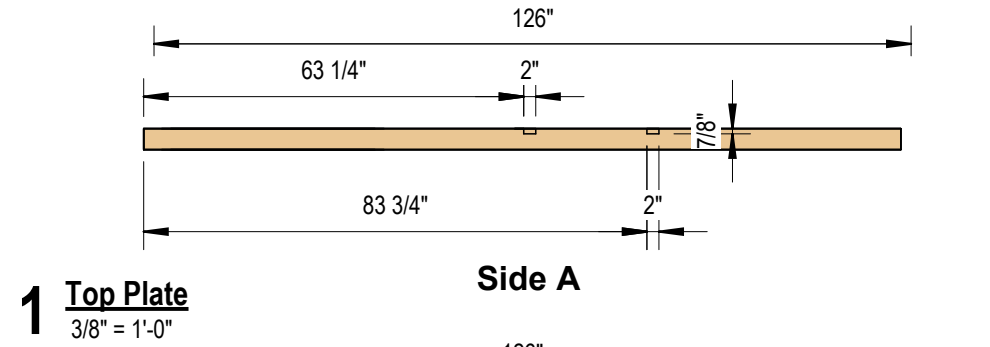

Structural Horizontal Framing Schedule

Mark	Piece Type	Description	Structural Material	Side	Cut Length
92	Bottom Plate	2x4	Pressure Treated SPF Standard		126"
93	Top Plate	2x4	SPF #1/#2		126"
94	Header	2x4	SPF #1/#2		37"
1170	Header	2x4	SPF #1/#2		34"

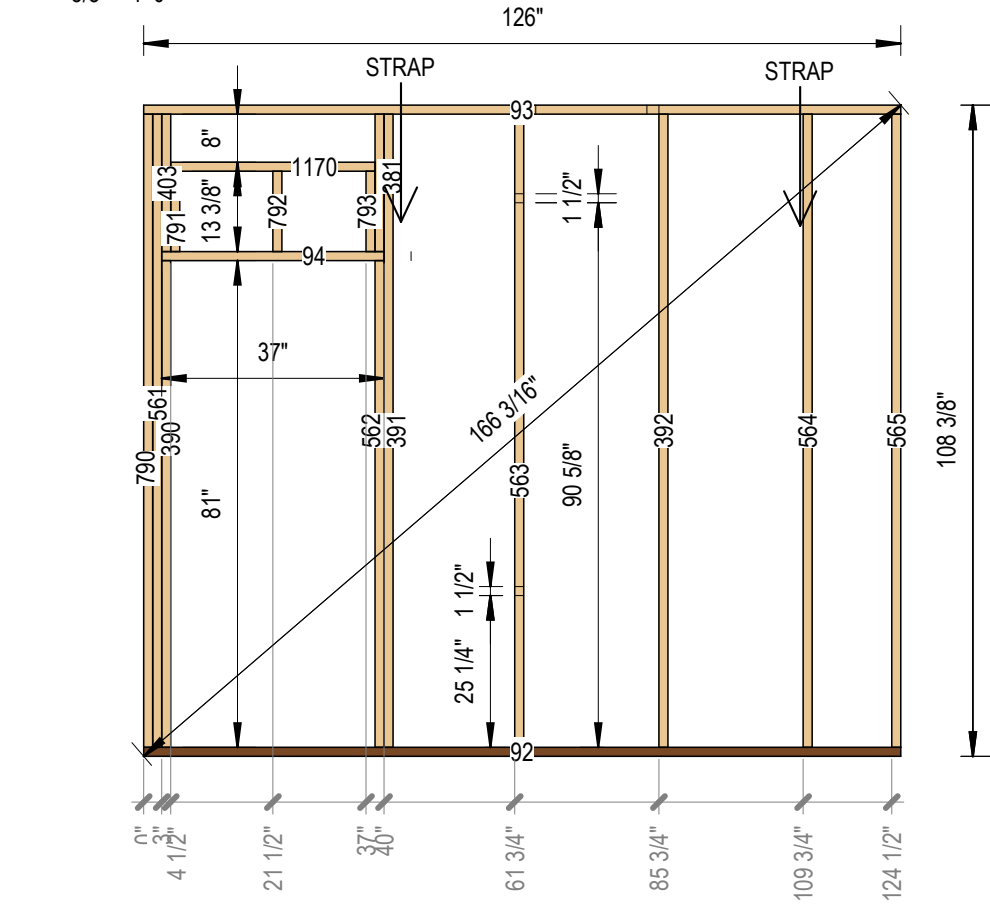

Structural Stud Schedule

Mark	Piece Type	Description	Structural Material	Side	Length
381	HeaderCripple	2x4	SPF #1/#2		22 7/8"
390	Trimmer	2x4	SPF #1/#2		81"
391	KingStud	2x4	SPF #1/#2		105 3/8"
392	Stud	2x4	SPF #1/#2		105 3/8"
403	HeaderCripple	2x4	SPF #1/#2		22 7/8"
561	KingStud	2x4	SPF #1/#2		105 3/8"
562	Trimmer	2x4	SPF #1/#2		81"
563	Stud	2x4	SPF #1/#2		105 3/8"
564	Stud	2x4	SPF #1/#2		105 3/8"
565	Stud	2x4	SPF #1/#2		105 3/8"
790	KingStud	2x4	SPF #1/#2		105 3/8"
791	HeaderCripple	2x4	SPF #1/#2		13 3/8"
792	HeaderCripple	2x4	SPF #1/#2		13 3/8"
793	HeaderCripple	2x4	SPF #1/#2		13 3/8"

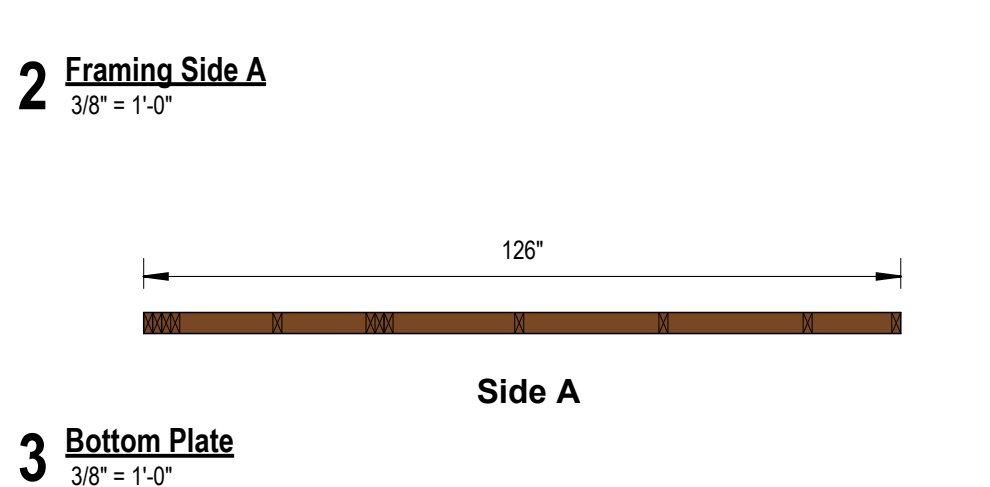

Structural Connection Schedule

Type	Count	Side
------	-------	------

SUMMERSTONE
1550P
LOT 60
ELEV-B-LEFT

11/7/2025	For Review	NOT FOR CONSTRUCTION

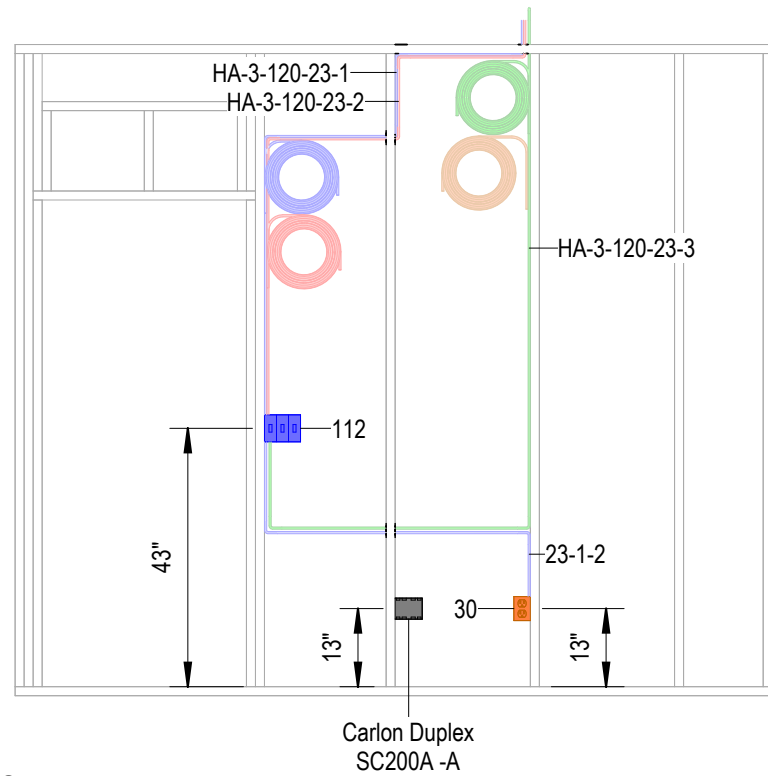

1 Electrical Side A
3/8" = 1'-0"

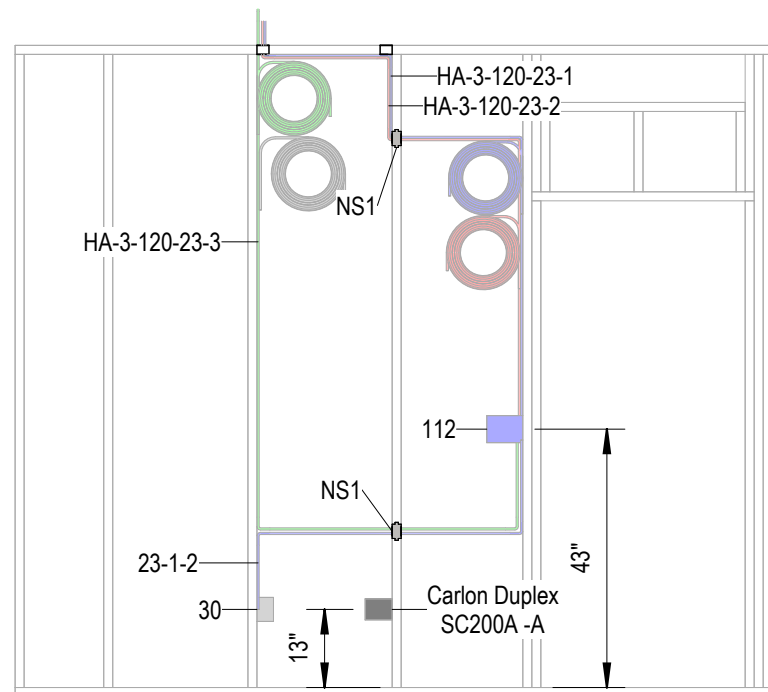

2 Electrical Side B
3/8" = 1'-0"

Electrical Fixture Schedule

Mark	Side	Box	Device-A	Device-B	Device-C	Device-D	Comments
30	A	EZ18SNW	Receptacle: T5320W				
112	A	EZ44TN	Standard Switch: 14512W	Standard Switch: 14512W	Standard Switch: 14512W		

Protection Plate Schedule

Count	Type	Side
2	NS1	B

Harness Assembly for TIE-120

Prefix-Quadrant-Wall-Circuit-Whip-Index	Type	Total Length	Pull To
HA-3-120-23-1	14/2	36' - 2"	JB3-7
HA-3-120-23-1-2	14/2	8' - 0"	
HA-3-120-23-2	14/3	30' - 3"	JB3-7
HA-3-120-23-3	14/3	23' - 9"	Ceiling Box 5

11/7/2025 For Review	NOT FOR CONSTRUCTION
----------------------	-----------------------------

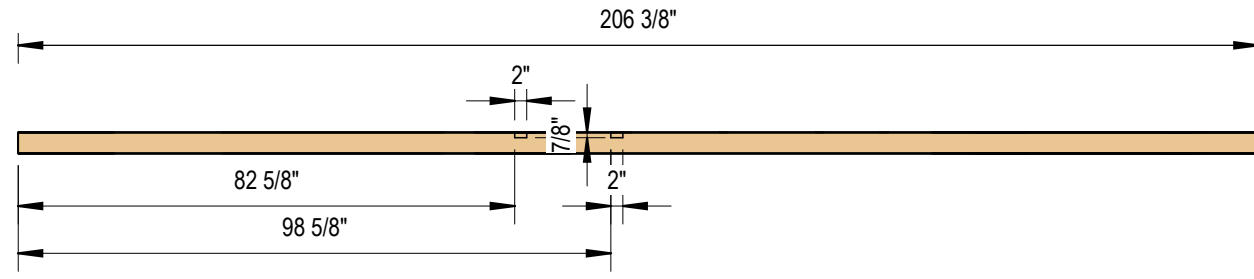

Side A

1 Top Plate
3/8" = 1'-0"

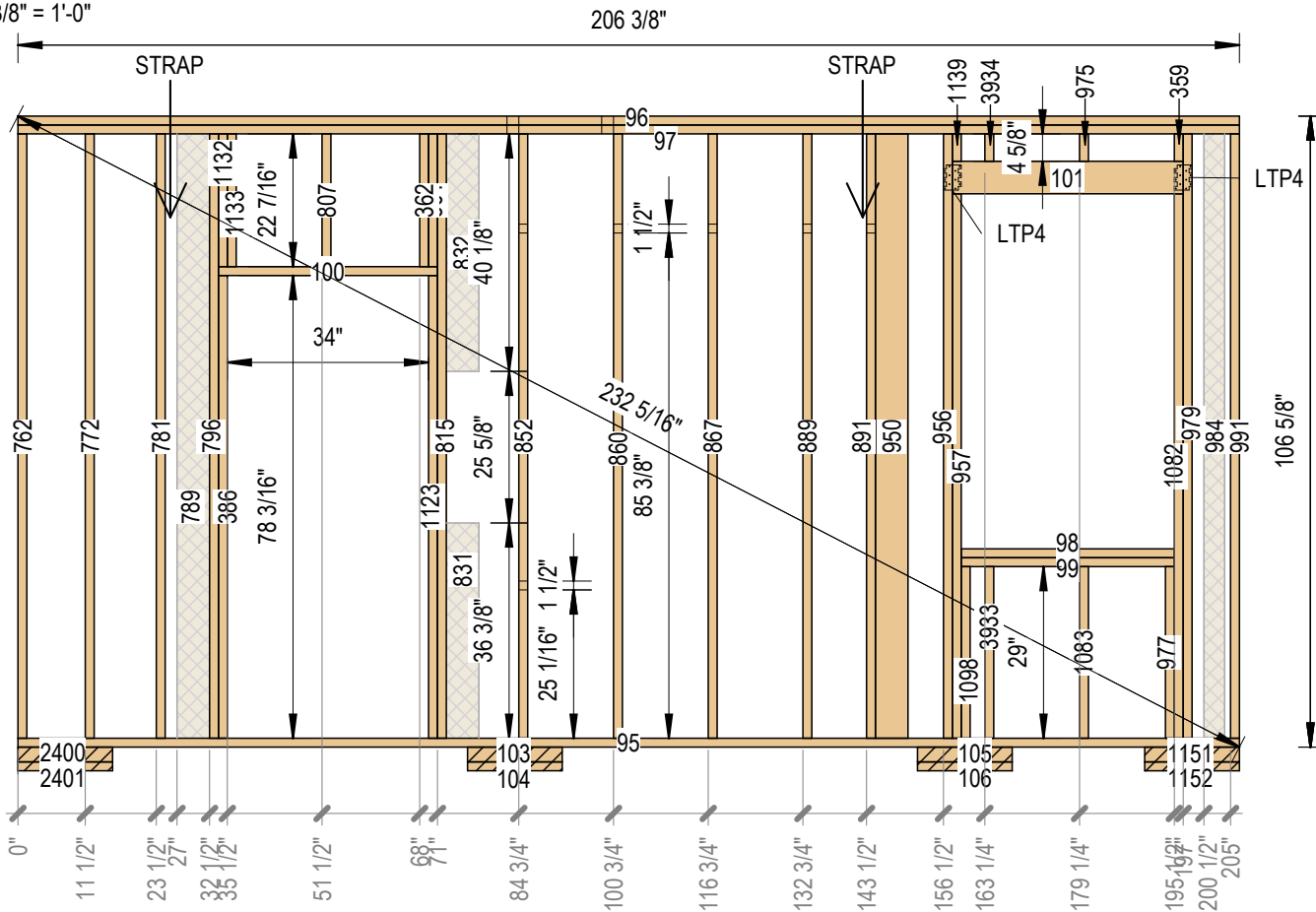

2 Framing Side A
3/8" = 1'-0"

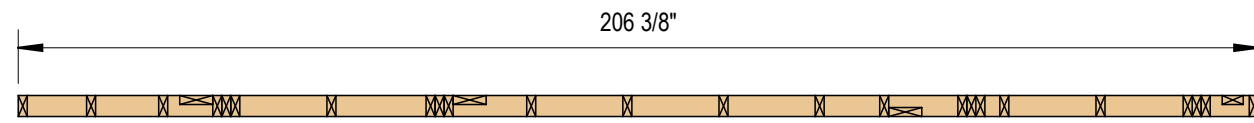

Side A

4 Bottom Plate
3/8" = 1'-0"

Structural Horizontal Framing Schedule

Mark	Piece Type	Description	Structural Material	Side	Cut Length
95	Bottom Plate	2x4	SPF #1/#2		206 3/8"
96	Top Plate	2x4	SPF #1/#2		206 3/8"
97	Top Plate	2x4	SPF #1/#2		206 3/8"
98	Sill	2x4	SPF #1/#2		36"
99	Sill	2x4	SPF #1/#2		36"
100	Header	2x4	SPF #1/#2		37"
101	Header	4x6	DF #2		39"
103	Temporary	3x4	SPF Standard		15 127/128"
104	Temporary	2x4	SPF Standard		15 127/128"
105	Temporary	3x4	SPF Standard		16"
106	Temporary	2x4	SPF Standard		16"
1151	Temporary	3x4	SPF Standard		16"
1152	Temporary	2x4	SPF Standard		16"
2400	Temporary	3x4	SPF Standard		15 125/128"
2401	Temporary	2x4	SPF Standard		15 63/64"

Structural Stud Schedule

Mark	Piece Type	Description	Structural Material	Side	Length
359	HeaderCripple	2x4	SPF #1/#2		4 5/8"
362	HeaderCripple	2x4	SPF #1/#2		22 7/16"
364	HeaderCripple	2x4	SPF #1/#2		22 7/16"
386	Trimmer	2x4	SPF #1/#2		78 3/16"
762	Stud	2x4	SPF #1/#2		102 1/8"
772	Stud	2x4	SPF #1/#2		102 1/8"
781	Stud	2x4	SPF #1/#2		102 1/8"
789 - B	FlatStud	2x6	SPF #1/#2	B	102 1/8"
796	KingStud	2x4	SPF #1/#2		102 1/8"
807	HeaderCripple	2x4	SPF #1/#2		22 7/16"
815	KingStud	2x4	SPF #1/#2		102 1/8"
831 - B	FlatStud	2x6	SPF #1/#2	B	36 3/8"
832 - B	FlatStud	2x6	SPF #1/#2	B	40 1/8"
852	Stud	2x4	SPF #1/#2		102 1/8"
860	Stud	2x4	SPF #1/#2		102 1/8"
867	Stud	2x4	SPF #1/#2		102 1/8"
889	Stud	2x4	SPF #1/#2		102 1/8"
891	Stud	2x4	SPF #1/#2		102 1/8"
950 - A	FlatStud	2x6	SPF #1/#2	A	102 1/8"
956	KingStud	2x4	SPF #1/#2		102 1/8"
957	Trimmer	2x4	SPF #1/#2		92"
975	HeaderCripple	2x4	SPF #1/#2		4 5/8"
977	SillCripple	2x4	SPF #1/#2		29"
979	KingStud	2x4	SPF #1/#2		102 1/8"
984 - B	FlatStud	2x4	SPF #1/#2	B	102 1/8"
991	Stud	2x4	SPF #1/#2		102 1/8"
1082	Trimmer	2x4	SPF #1/#2		92"
1083	SillCripple	2x4	SPF #1/#2		29"
1098	SillCripple	2x4	SPF #1/#2		29"
1123	Trimmer	2x4	SPF #1/#2		78 3/16"
1132	HeaderCripple	2x4	SPF #1/#2		22 7/16"
1133	HeaderCripple	2x4	SPF #1/#2		22 7/16"
1139	HeaderCripple	2x4	SPF #1/#2		4 5/8"
3933	SillCripple	2x4	SPF #1/#2		29"
3934	HeaderCripple	2x4	SPF #1/#2		4 5/8"

Structural Connection Schedule

Type	Count	Side
LTP4	2	B

Vertical Wall Sheathing Schedule				
Mark	Description	Thickness	Length	Height
66	Picasso	1"	39"	33 5/8"
88	Picasso	1"	35 3/8"	108"
89	Picasso	1"	48"	108"
91	Picasso	1"	9 1/2"	108"
92	Picasso	1"	34"	26 11/16"
93	Picasso	1"	39"	11 3/8"
162	Picasso	1"	9 1/2"	108"
170	Picasso	1"	27 1/2"	108"

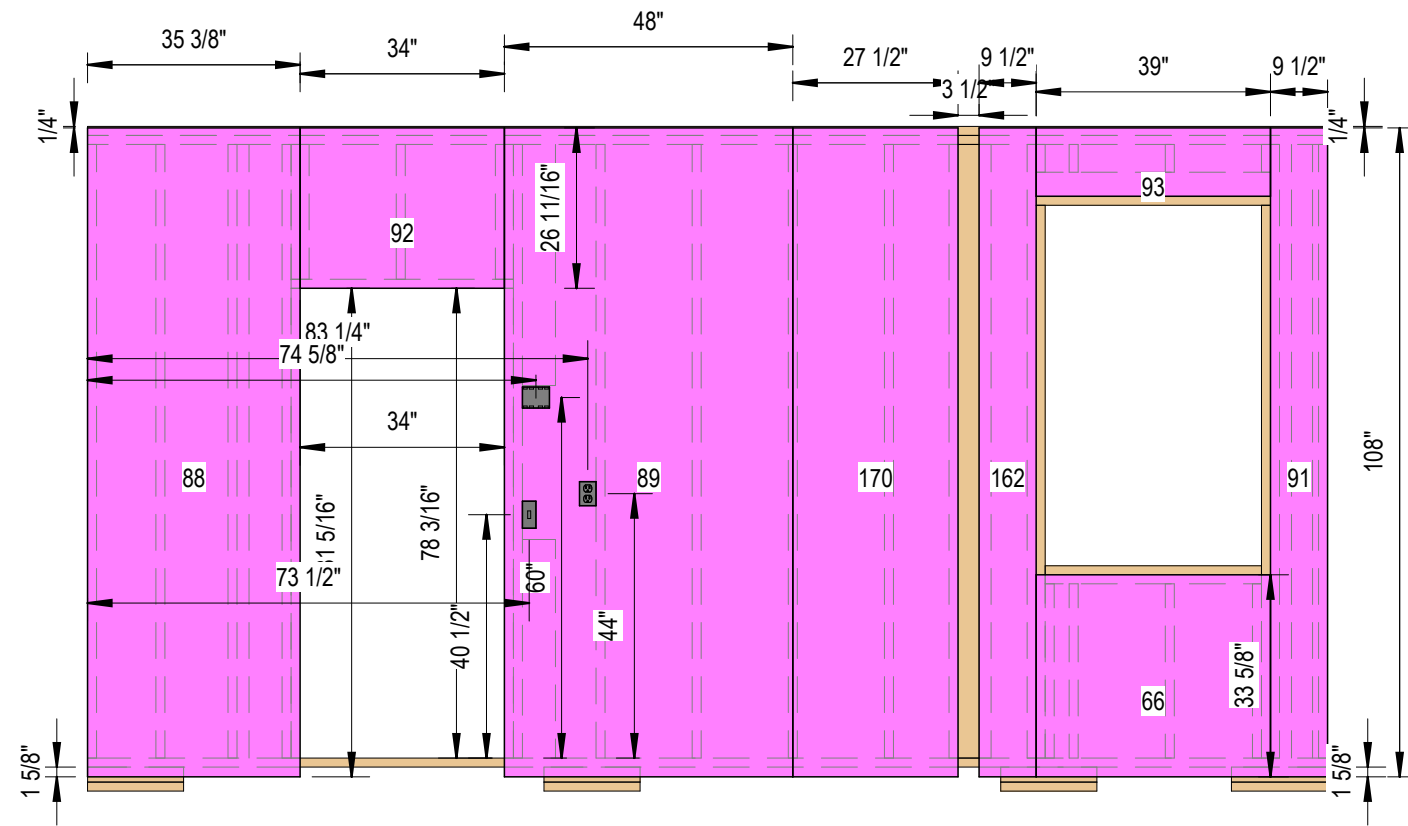

1 Sheathing Side A
3/8" = 1'-0"

SUMMERSTONE
1550P
 LOT 60
 ELEV-B-LEFT

11/7/2025	For Review	NOT FOR CONSTRUCTION

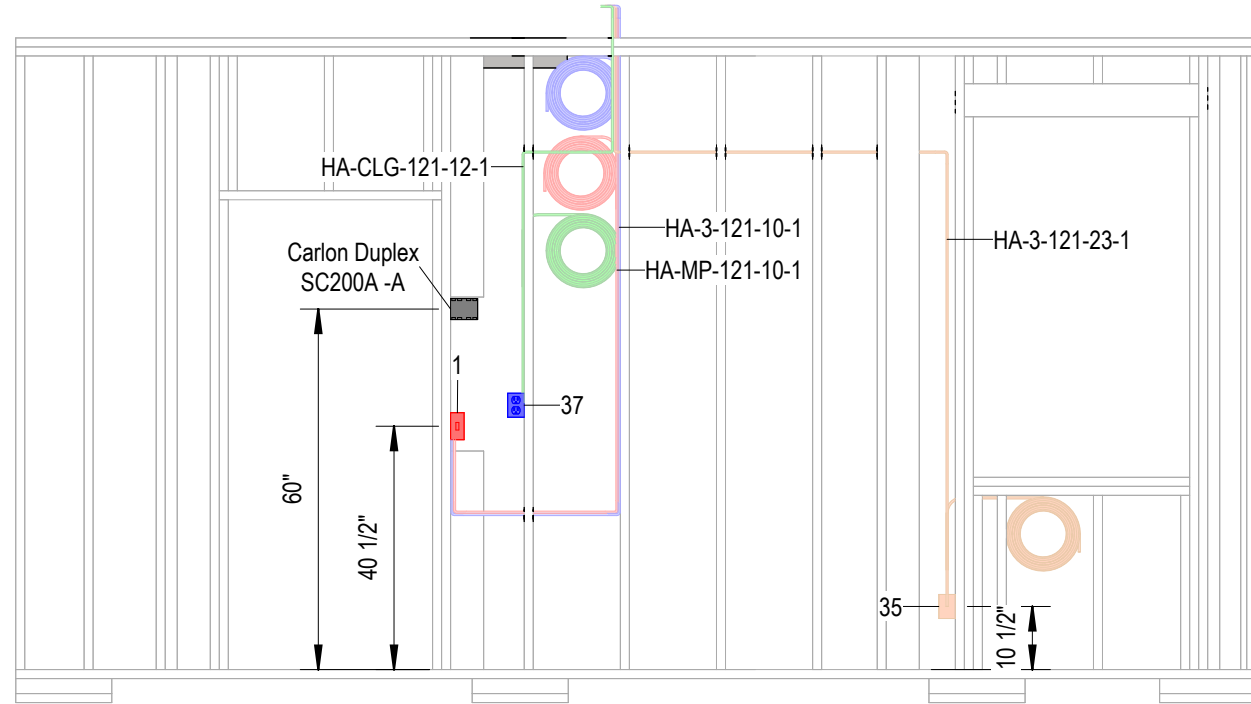

1 Electrical Side A
3/8" = 1'-0"

Electrical Fixture Schedule							
Mark	Side	Box	Device-A	Device-B	Device-C	Device-D	Comments
1	A	EZ18SNW	Standard Switch: 14512W				Provide fire putty
35	B	EZ18SNW	Receptacle: T5320W				
37	A	EZ18SNW	Receptacle: T5320W				Provide fire putty

Protection Plate Schedule		
Count	Type	Side
6	NS1	B
1	PSPN516Z	

Harness Assembly for TEE-121			
Prefix-Quadrant-Wall-Circuit-Whip-Index	Type	Total Length	Pull To
HA-3-121-10-1	14/2	36' - 5"	Light Fixtures 50-51
HA-3-121-23-1	14/2	49' - 5"	JB3-7
HA-CLG-121-12-1	12/2	29' - 10"	Ceiling Box 13
HA-MP-121-10-1	14/2	56' - 1"	Panel 145, MP

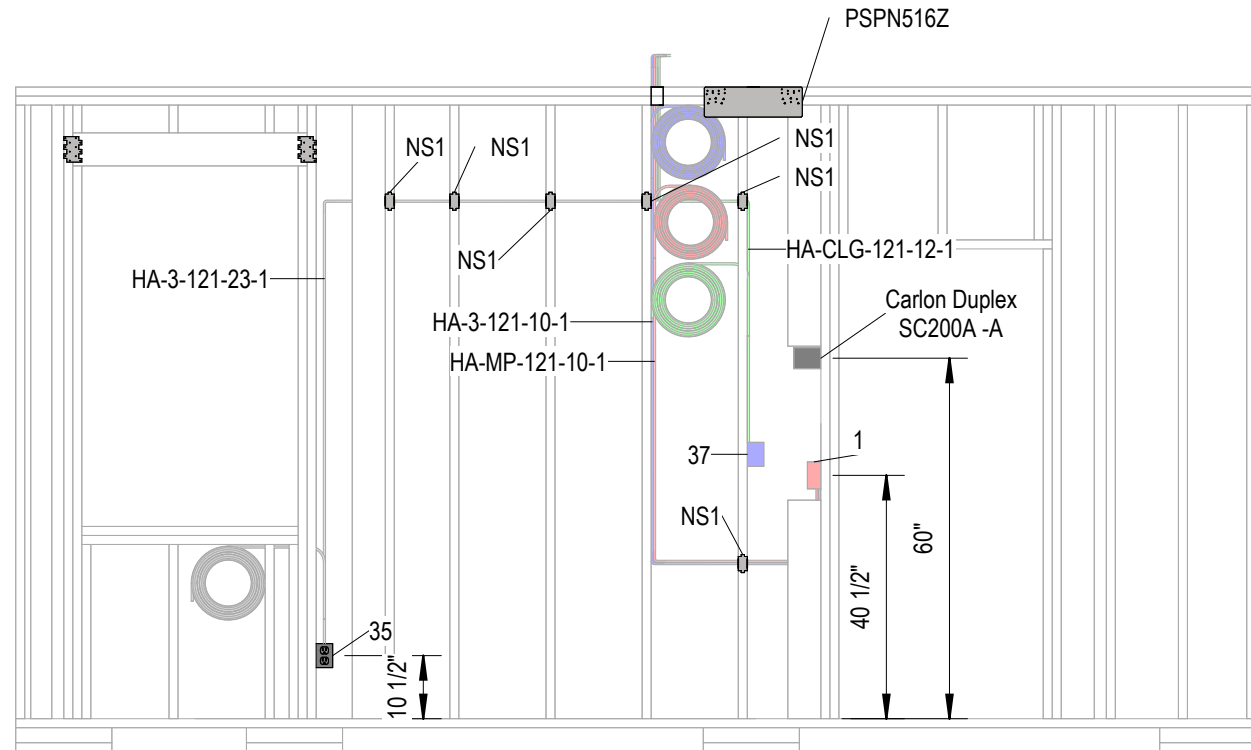

2 Electrical Side B
3/8" = 1'-0"

SUMMERSTONE
1550P
LOT 60
ELEV-B-LEFT

11/7/2025	For Review	NOT FOR CONSTRUCTION

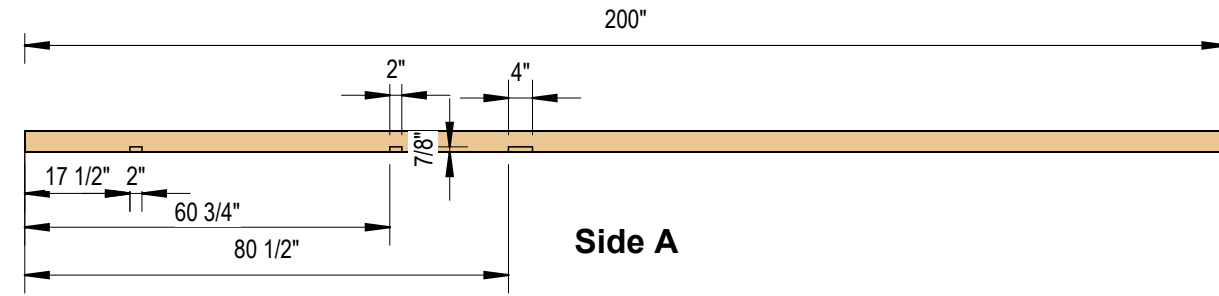

1 Top Plate
3/8" = 1'-0"

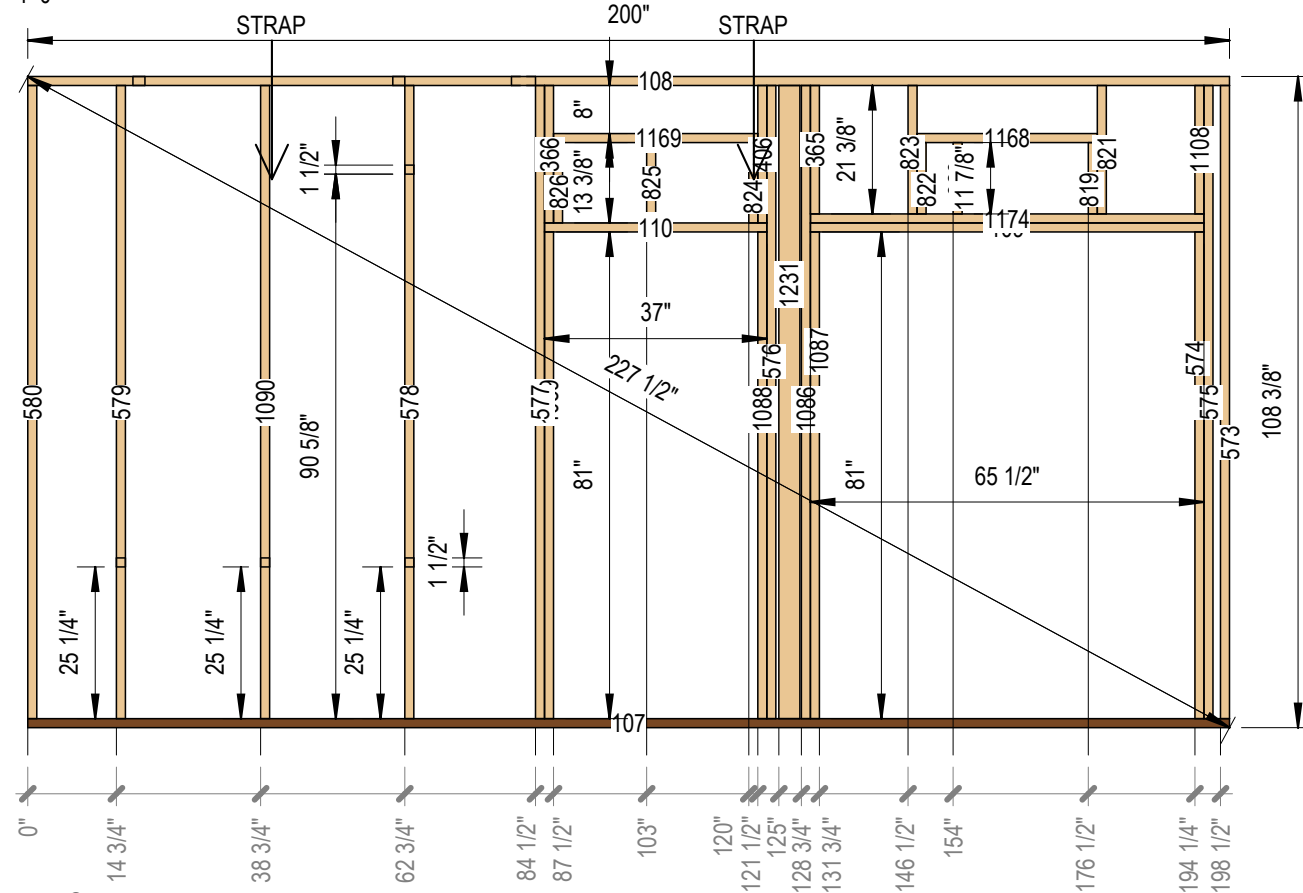

2 Framing Side A
3/8" = 1'-0"

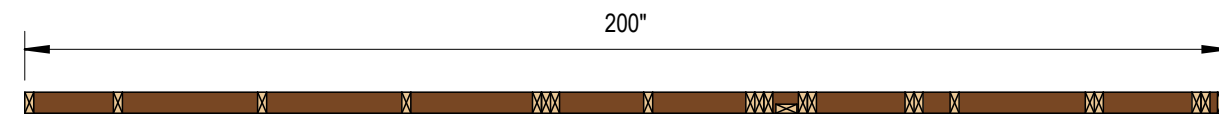

4 Bottom Plate
3/8" = 1'-0"

Structural Horizontal Framing Schedule

Mark	Piece Type	Description	Structural Material	Side	Cut Length
107	Bottom Plate	2x4	Pressure Treated SPF Standard		200"
108	Top Plate	2x4	SPF #1/#2		200"
109	Header	2x4	SPF #1/#2		65 1/2"
110	Header	2x4	SPF #1/#2		37"
1168	Header	2x4	SPF #1/#2		30"
1169	Header	2x4	SPF #1/#2		34"
1174	Header	2x4	SPF #1/#2		65 61/128"

Structural Stud Schedule

Mark	Piece Type	Description	Structural Material	Side	Length
365	HeaderCripple	2x4	SPF #1/#2		21 3/8"
366	HeaderCripple	2x4	SPF #1/#2		22 7/8"
406	HeaderCripple	2x4	SPF #1/#2		22 7/8"
573	Stud	2x4	SPF #1/#2		105 3/8"
574	Trimmer	2x4	SPF #1/#2		81"
575	KingStud	2x4	SPF #1/#2		105 3/8"
576	KingStud	2x4	SPF #1/#2		105 3/8"
577	KingStud	2x4	SPF #1/#2		105 3/8"
578	Stud	2x4	SPF #1/#2		105 3/8"
579	Stud	2x4	SPF #1/#2		105 3/8"
580	Stud	2x4	SPF #1/#2		105 3/8"
819	HeaderCripple	2x4	SPF #1/#2		11 7/8"
820	HeaderCripple	2x4	SPF #1/#2		11 7/8"
821	HeaderCripple	2x4	SPF #1/#2		21 3/8"
822	HeaderCripple	2x4	SPF #1/#2		11 7/8"
823	HeaderCripple	2x4	SPF #1/#2		21 3/8"
824	HeaderCripple	2x4	SPF #1/#2		13 3/8"
825	HeaderCripple	2x4	SPF #1/#2		13 3/8"
826	HeaderCripple	2x4	SPF #1/#2		13 3/8"
1086	KingStud	2x4	SPF #1/#2		105 3/8"
1087	Trimmer	2x4	SPF #1/#2		81"
1088	Trimmer	2x4	SPF #1/#2		81"
1089	Trimmer	2x4	SPF #1/#2		81"
1090	Stud	2x4	SPF #1/#2		105 3/8"
1108	HeaderCripple	2x4	SPF #1/#2		21 3/8"
1231 - A	FlatStud	2x4	SPF Standard	A	105 3/8"

Structural Connection Schedule

Type	Count	Side
------	-------	------

SUMMERSTONE
1550P
LOT 60
ELEV-B-LEFT

11/7/2025 For Review

NOT FOR CONSTRUCTION

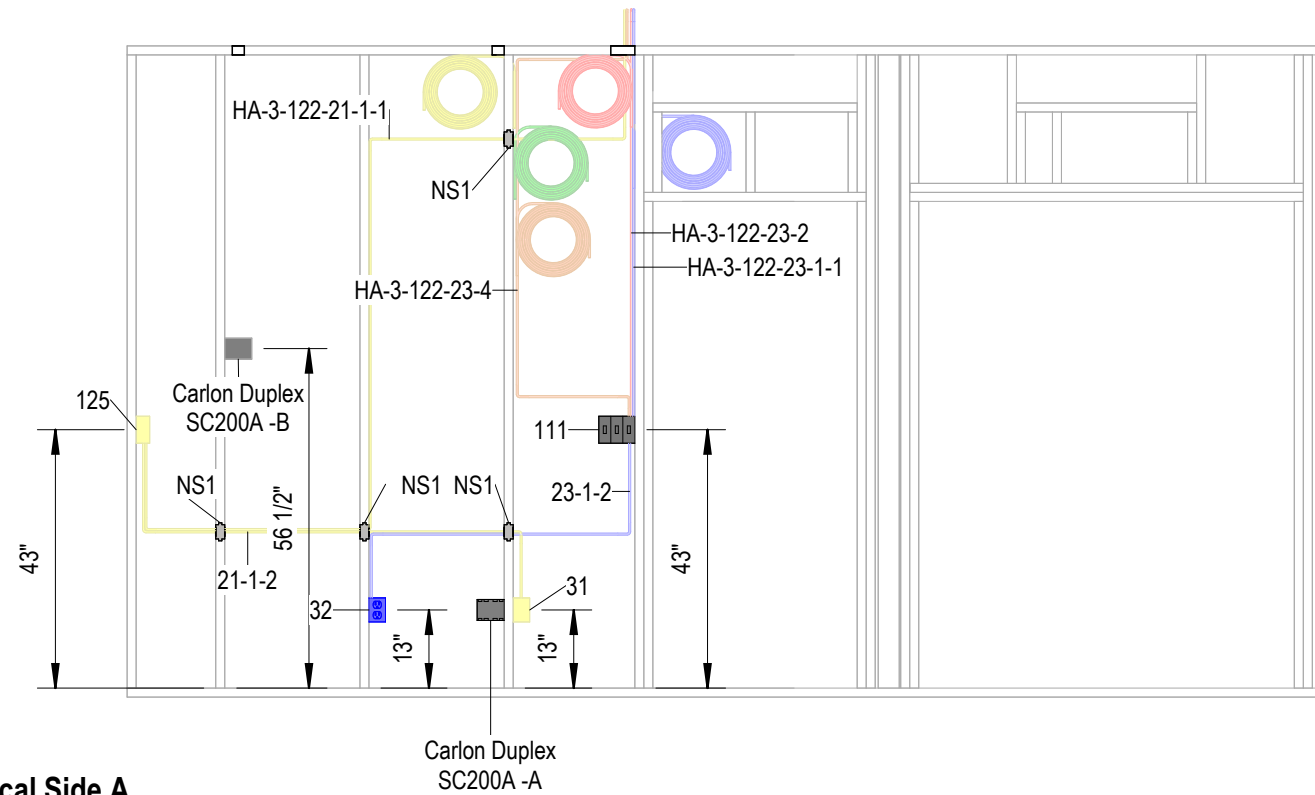

1 Electrical Side A
3/8" = 1'-0"

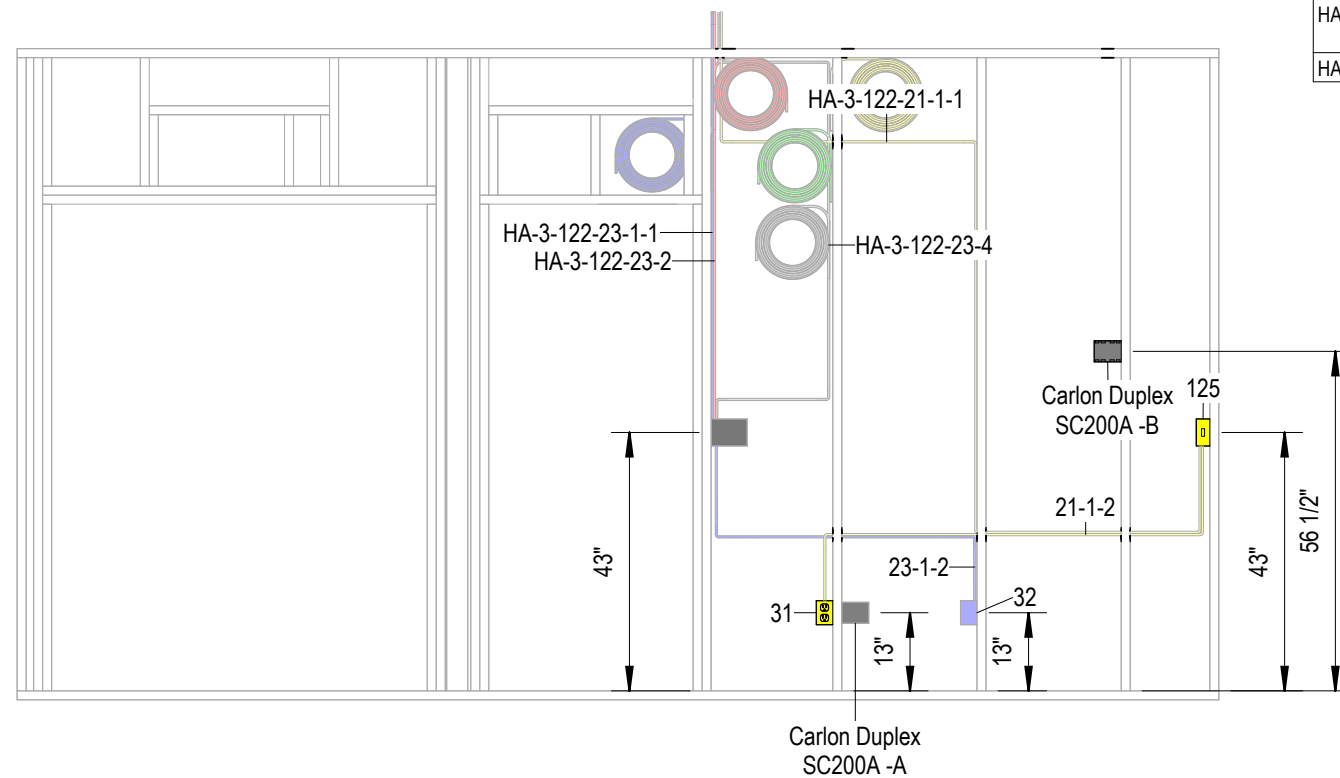

2 Electrical Side B
3/8" = 1'-0"

Electrical Fixture Schedule							
Mark	Side	Box	Device-A	Device-B	Device-C	Device-D	Comments
31	B	EZ18SNW	Receptacle: T5320W				
32	A	EZ18SNW	Receptacle: T5320W				
111	A	EZ44TN	Standard Switch: 14512W	Standard Switch: 14512W	Standard Switch: 14512W		
125	B	EZ18SNW	Standard Switch: 14512W				

Protection Plate Schedule		
Count	Type	Side
4	NS1	A

Harness Assembly for TIE-122			
Prefix-Quadrant-Wall-Circuit-Whip-Index	Type	Total Length	Pull To
HA-3-122-21-1-1	14/3	40' - 2"	Panel 124, Box 109, Device A
HA-3-122-21-1-2	14/2	9' - 6"	
HA-3-122-23-1-1	14/2	31' - 8"	JB3-7
HA-3-122-23-1-2	12/2	7' - 11"	
HA-3-122-23-2	14/3	32' - 7"	Panel 126, Box 34, Device A
HA-3-122-23-4	14/3	20' - 4"	Ceiling Box 6

SUMMERSTONE
1550P
LOT 60
ELEV-B-LEFT

11/7/2025 For Review
NOT FOR CONSTRUCTION

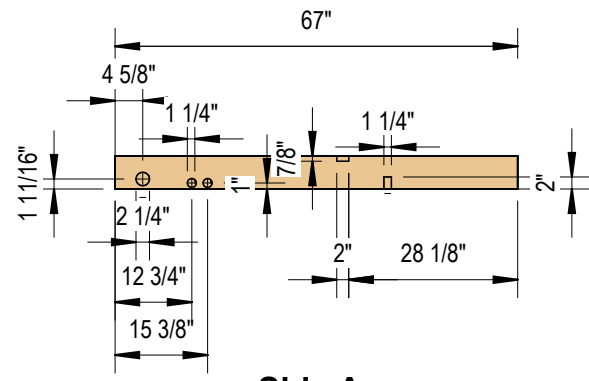

1 Top Plate
3/8" = 1'-0"

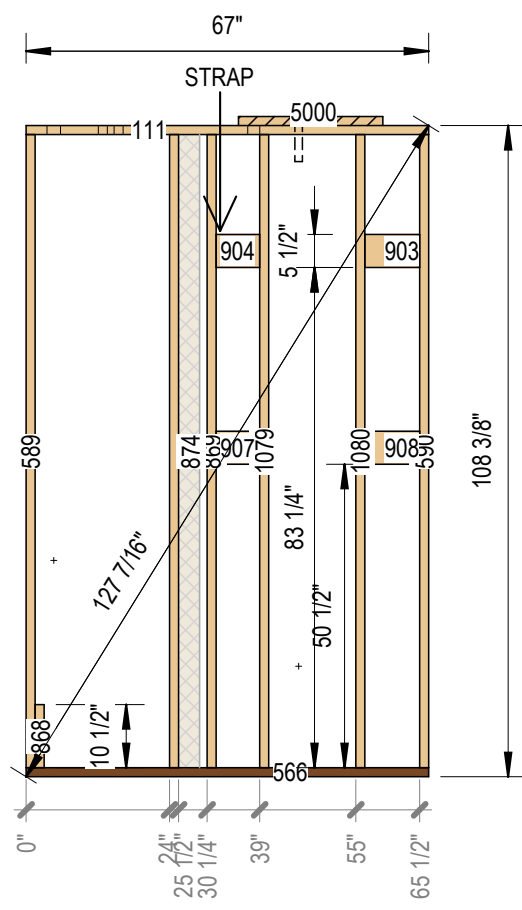

2 Framing Side A
3/8" = 1'-0"



Side A

4 Bottom Plate
3/8" = 1'-0"

Structural Horizontal Framing Schedule

Mark	Piece Type	Description	Structural Material	Side	Cut Length
111	Top Plate	2x6	SPF #1/#2		67"
566	Bottom Plate	2x6	Pressure Treated SPF Standard		67"
903 - A	Flat Blocking	2x6	SPF #1/#2	A	9 1/8"
904 - A	Flat Blocking	2x6	SPF #1/#2	A	7 1/4"
907 - A	Flat Blocking	2x6	SPF #1/#2	A	7 1/4"
908 - A	Flat Blocking	2x6	SPF #1/#2	A	9 1/8"
5000	Temporary	2x4	SPF #1/#2		24 7/256"

Structural Stud Schedule

Mark	Piece Type	Description	Structural Material	Side	Length
589	Stud	2x6	SPF #1/#2		105 3/8"
590	Stud	2x6	SPF #1/#2		105 3/8"
868	Stud	2x6	SPF #1/#2		10 1/2"
869	Stud	2x6	SPF #1/#2		105 3/8"
874 - B	FlatStud	2x4	SPF #1/#2	B	105 3/8"
1078	Stud	2x6	SPF #1/#2		105 3/8"
1079	Stud	2x6	SPF #1/#2		105 3/8"
1080	Stud	2x6	SPF #1/#2		105 3/8"

Structural Connection Schedule

Type	Count	Side



SUMMERSTONE
1550P
LOT 60
ELEV-B-LEFT

11/7/2025 For Review				NOT FOR CONSTRUCTION

Structural Framing
123.1-TIPE

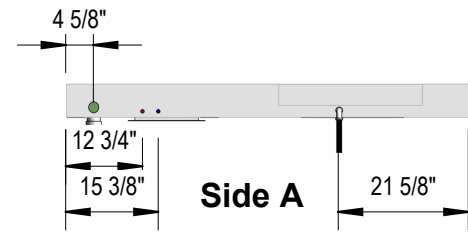

1 Top Plumbing View
3/8" = 1'-0"

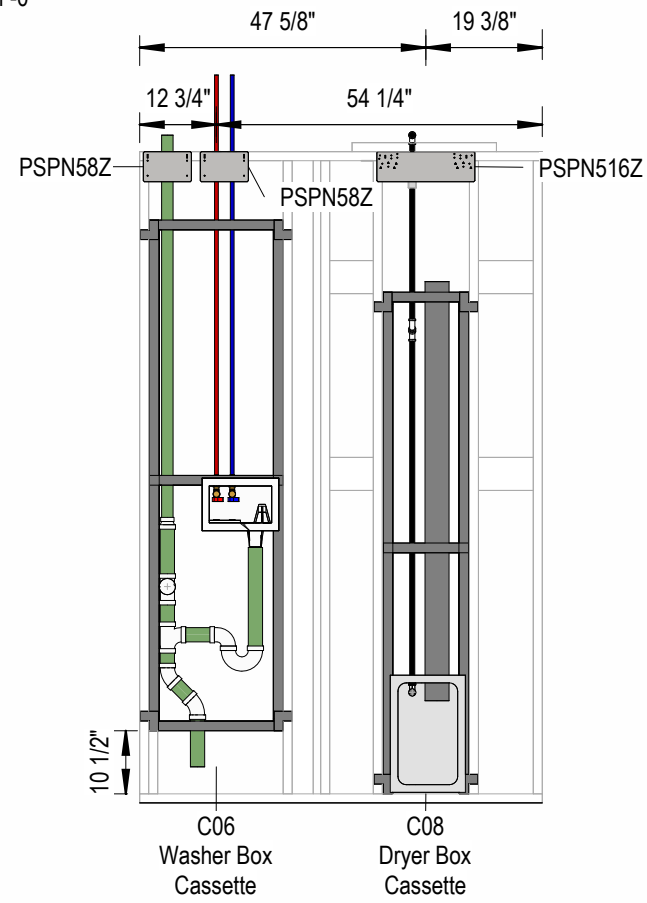

2 Plumbing Side A
3/8" = 1'-0"

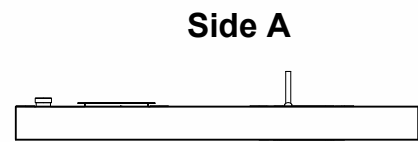

3 Bottom Plumbing View
3/8" = 1'-0"

Plumbing Fixtures Schedule		
Cassette ID	Type	.Side
C06	Washer Box Cassette	A
C08	Dryer Box Cassette	A

Protection Plate schedule		
Count	Type	Side
2	PSPN58Z	A
1	PSPN516Z	A



SUMMERSTONE
1550P
LOT 60
ELEV-B-LEFT

11/7/2025 For Review				NOT FOR CONSTRUCTION

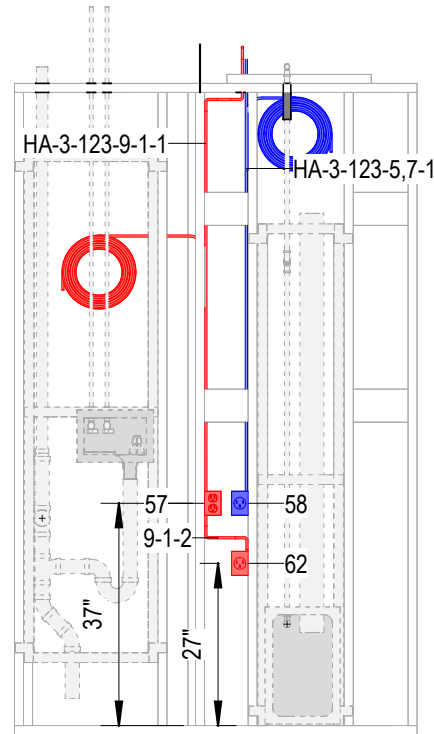

1 Electrical Side A
3/8" = 1'-0"

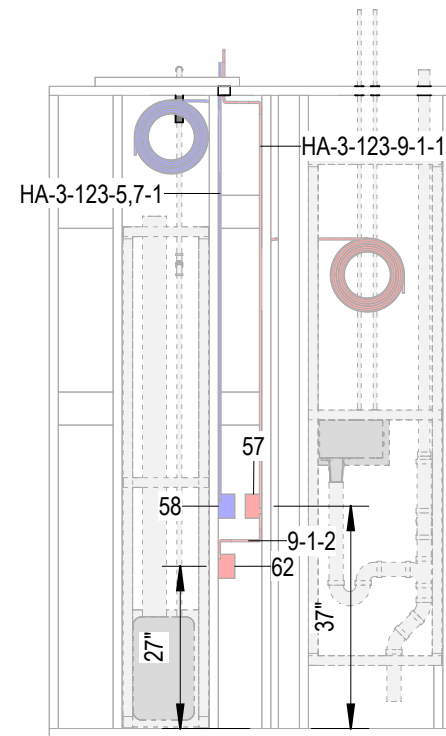

2 Electrical Side B
3/8" = 1'-0"

Electrical Fixture Schedule

Mark	Side	Box	Device-A	Device-B	Device-C	Device-D	Comments
57	A	EZ18SNW	Receptacle: T5320W				Washer
58	A	EZ32DN	278S00				Dryer 240V
62	A	EZ18SNW	Receptacle: T5020WS				Dryer 120V

Protection Plate Schedule

Count	Type	Side
-------	------	------

Harness Assembly for TIPE-123

Prefix-Quadrant-Wall-Circuit-Whip-Index	Type	Total Length	Pull To
HA-3-123-5,7-1	<varies>	79' - 7"	JB3-6
HA-3-123-9-1-1	12/2	29' - 2"	JB3-4
HA-3-123-9-1-2	12/2	3' - 2"	

11/7/2025	For Review					NOT FOR CONSTRUCTION
-----------	------------	--	--	--	--	-----------------------------

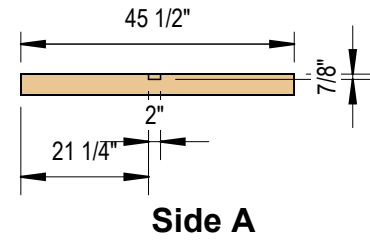

1 Top Plate
3/8" = 1'-0"

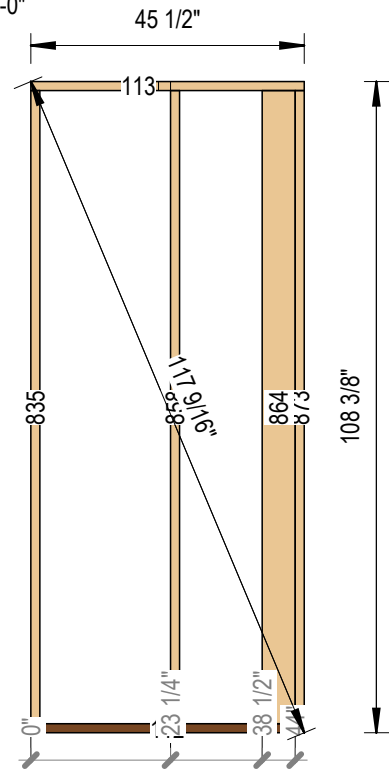

2 Framing Side A
3/8" = 1'-0"

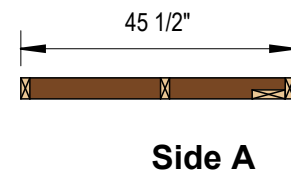

4 Bottom Plate
3/8" = 1'-0"

Structural Horizontal Framing Schedule

Mark	Piece Type	Description	Structural Material	Side	Cut Length
112	Bottom Plate	2x4	Pressure Treated SPF Standard		45 1/2"
113	Top Plate	2x4	SPF #1/#2		45 1/2"

Structural Stud Schedule

Mark	Piece Type	Description	Structural Material	Side	Length
835	Stud	2x4	SPF #1/#2		105 3/8"
858	Stud	2x4	SPF #1/#2		105 3/8"
864 - A	FlatStud	2x6	SPF #1/#2	A	105 3/8"
873	Stud	2x4	SPF #1/#2		105 3/8"

Structural Connection Schedule

Type	Count	Side
------	-------	------

11/7/2025 For Review					NOT FOR CONSTRUCTION

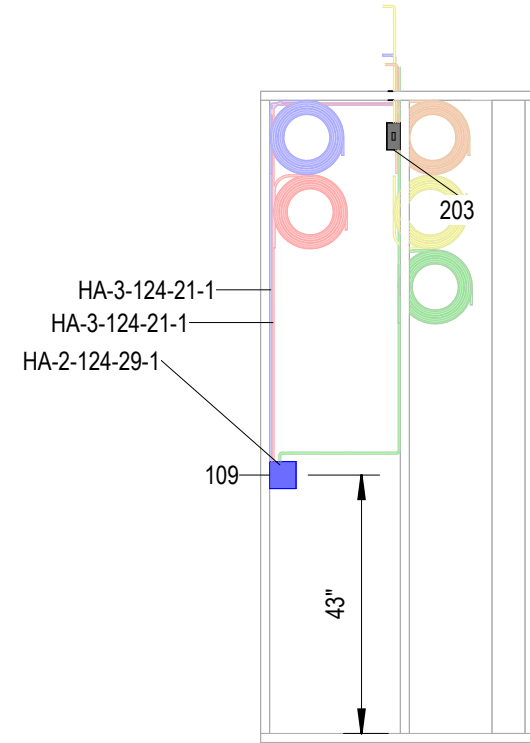

1 Electrical Side A
3/8" = 1'-0"

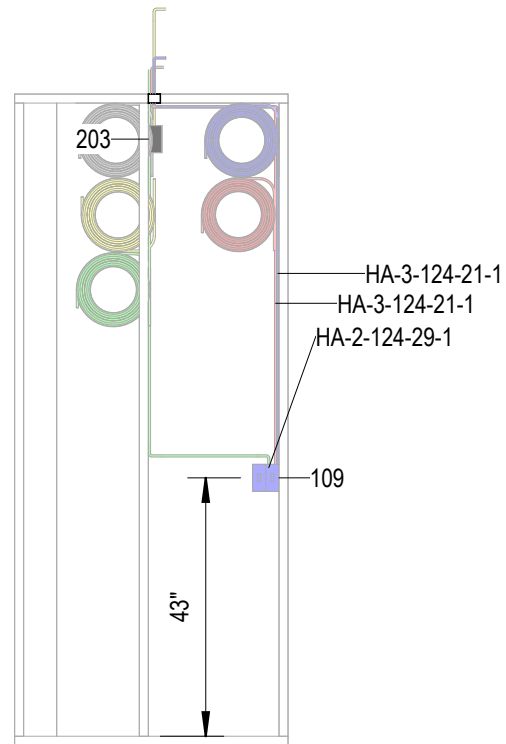

2 Electrical Side B
3/8" = 1'-0"

Electrical Fixture Schedule							
Mark	Side	Box	Device-A	Device-B	Device-C	Device-D	Comments
109	A	EZ32DN	3-Way Switch: 56032W	4-Way Switch: 5604-SWS			
203	A	EZ18SNW	Standard Switch: 14512W				

Protection Plate Schedule		
Count	Type	Side

Harness Assembly for TIE-124			
Prefix-Quadrant-Wall-Circuit-Whip-Index	Type	Total Length	Pull To
HA-1-124-27-1	<varies>	36' - 4"	JB1-4
HA-1-124-27-2	<varies>	33' - 7"	ATTC Fixture 193
HA-2-124-29-1	14/3	33' - 5"	Panel 126, Box 107 , Device B
HA-3-124-21-1	14/2	51' - 3"	<varies>

SUMMERSTONE
1550P
LOT 60
ELEV-B-LEFT

11/7/2025	For Review					NOT FOR CONSTRUCTION
-----------	------------	--	--	--	--	-----------------------------

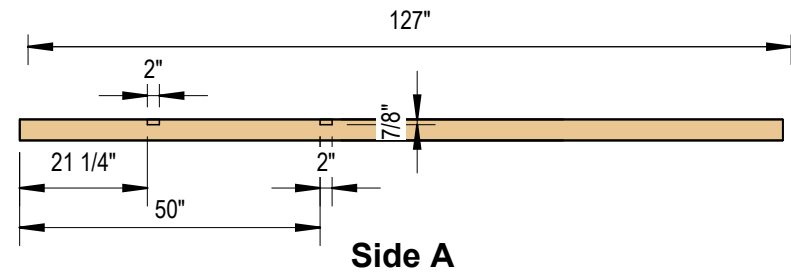

1 Top Plate
3/8" = 1'-0"

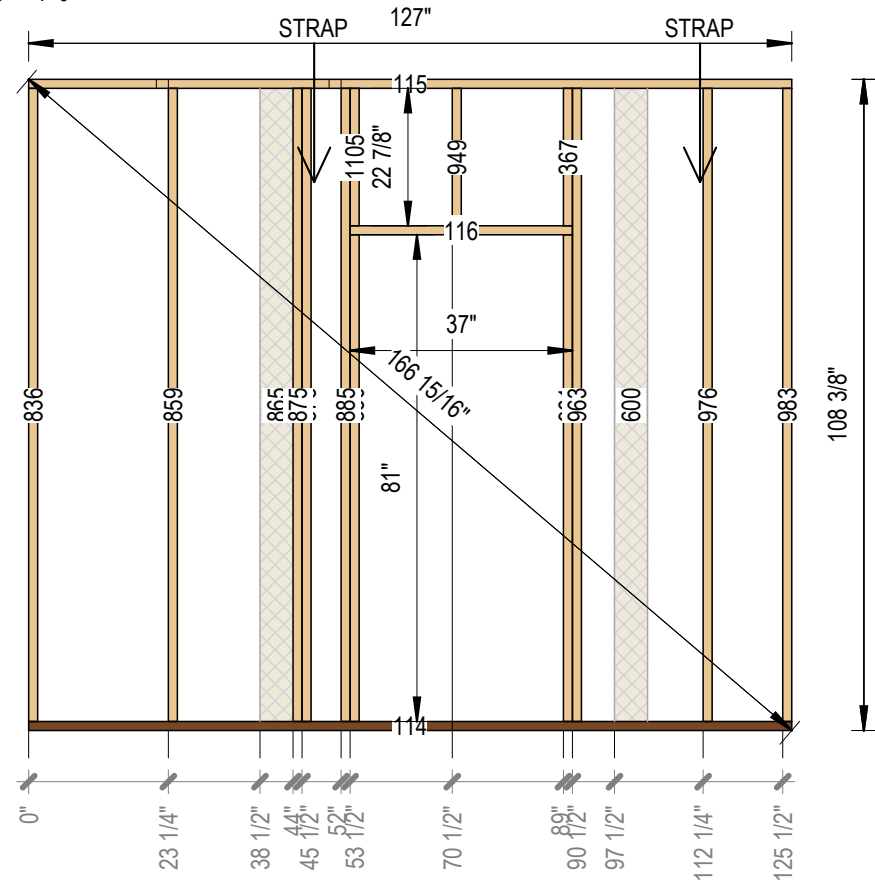

2 Framing Side A
3/8" = 1'-0"

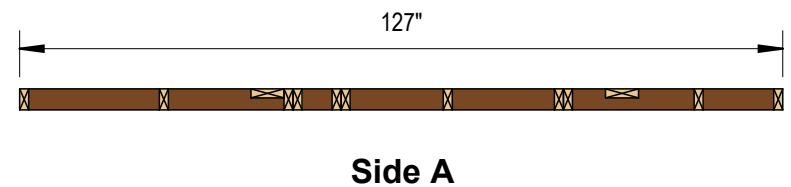

4 Bottom Plate
3/8" = 1'-0"

Structural Horizontal Framing Schedule

Mark	Piece Type	Description	Structural Material	Side	Cut Length
114	Bottom Plate	2x4	Pressure Treated SPF Standard		127"
115	Top Plate	2x4	SPF #1/#2		127"
116	Header	2x4	SPF #1/#2		37"

Structural Stud Schedule

Mark	Piece Type	Description	Structural Material	Side	Length
367	HeaderCripple	2x4	SPF #1/#2		22 7/8"
600 - B	FlatStud	2x6	SPF #1/#2	B	105 3/8"
836	Stud	2x4	SPF #1/#2		105 3/8"
859	Stud	2x4	SPF #1/#2		105 3/8"
865 - B	FlatStud	2x6	SPF #1/#2	B	105 3/8"
875	Stud	2x4	SPF #1/#2		105 3/8"
878	Stud	2x4	SPF #1/#2		105 3/8"
885	KingStud	2x4	SPF #1/#2		105 3/8"
886	Trimmer	2x4	SPF #1/#2		81"
949	HeaderCripple	2x4	SPF #1/#2		22 7/8"
961	Trimmer	2x4	SPF #1/#2		81"
963	KingStud	2x4	SPF #1/#2		105 3/8"
976	Stud	2x4	SPF #1/#2		105 3/8"
983	Stud	2x4	SPF #1/#2		105 3/8"
1105	HeaderCripple	2x4	SPF #1/#2		22 7/8"

Structural Connection Schedule

Type	Count	Side
------	-------	------

11/7/2025	For Review					NOT FOR CONSTRUCTION
-----------	------------	--	--	--	--	-----------------------------

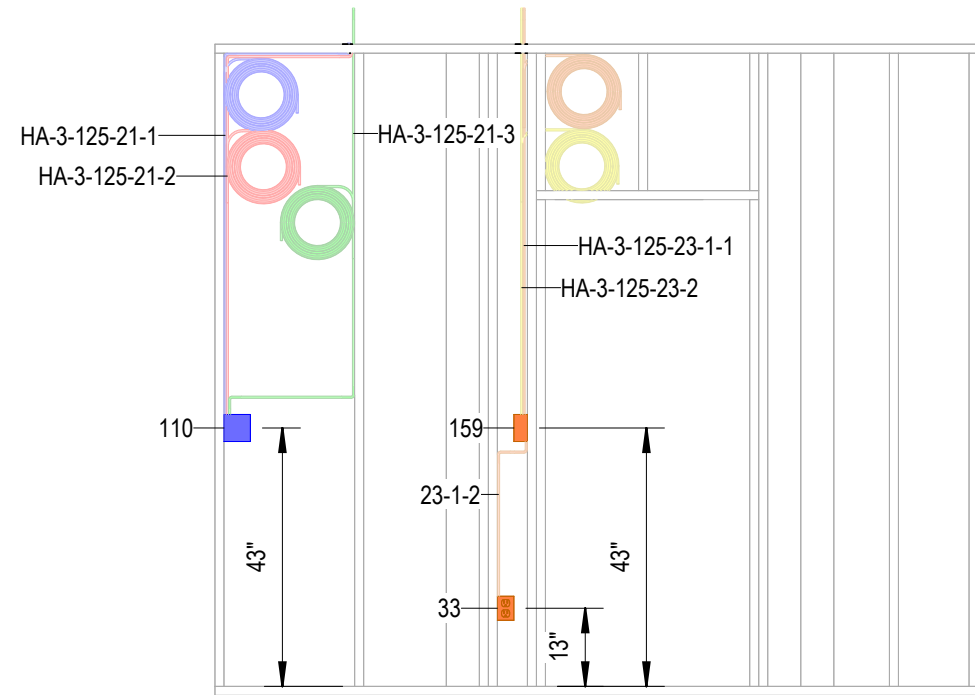

1 Electrical Side A
3/8" = 1'-0"

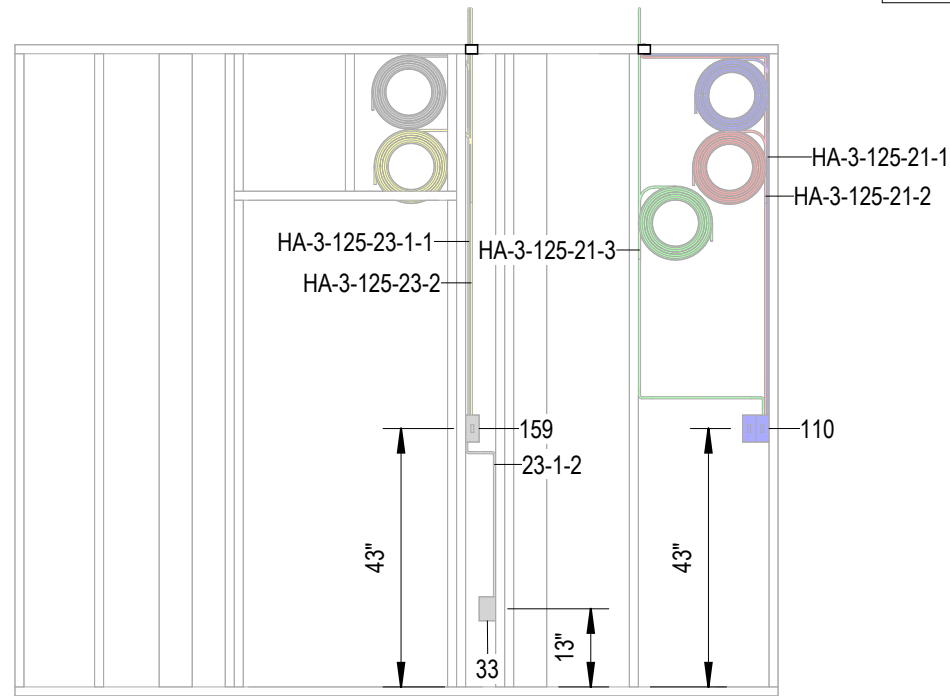

2 Electrical Side B
3/8" = 1'-0"

Electrical Fixture Schedule

Mark	Side	Box	Device-A	Device-B	Device-C	Device-D	Comments
33	A	EZ18SNW	Receptacle: T5320W				
110	A	EZ32DN	Standard Switch: 14512W	Fan Switch: 14512W			
159	A	EZ18SNW	Standard Switch: 14512W				

Protection Plate Schedule

Count	Type	Side

Harness Assembly for TIE-125

Prefix-Quadrant-Wall-Circuit-Whip-Index	Type	Total Length	Pull To
HA-3-125-21-1	14/2	28' - 4"	JB3-1
HA-3-125-21-2	14/2	14' - 4"	Light Fixture 36
HA-3-125-21-3	14/2	13' - 11"	Ceiling Box 201
HA-3-125-23-1-1	14/2	31' - 6"	JB3-7
HA-3-125-23-1-2	14/2	4' - 11"	
HA-3-125-23-2	14/2	13' - 1"	Light Fixture 52

SUMMERSTONE
1550P
LOT 60
ELEV-B-LEFT

11/7/2025 For Review
NOT FOR CONSTRUCTION

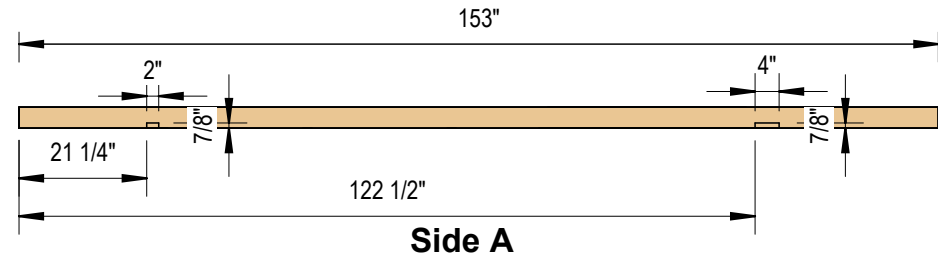

1 Top Plate
3/8" = 1'-0"

Structural Horizontal Framing Schedule

Mark	Piece Type	Description	Structural Material	Side	Cut Length
117	Bottom Plate	2x4	Pressure Treated SPF Standard		153"
118	Top Plate	2x4	SPF #1/#2		153"
119	Header	2x4	SPF #1/#2		33"

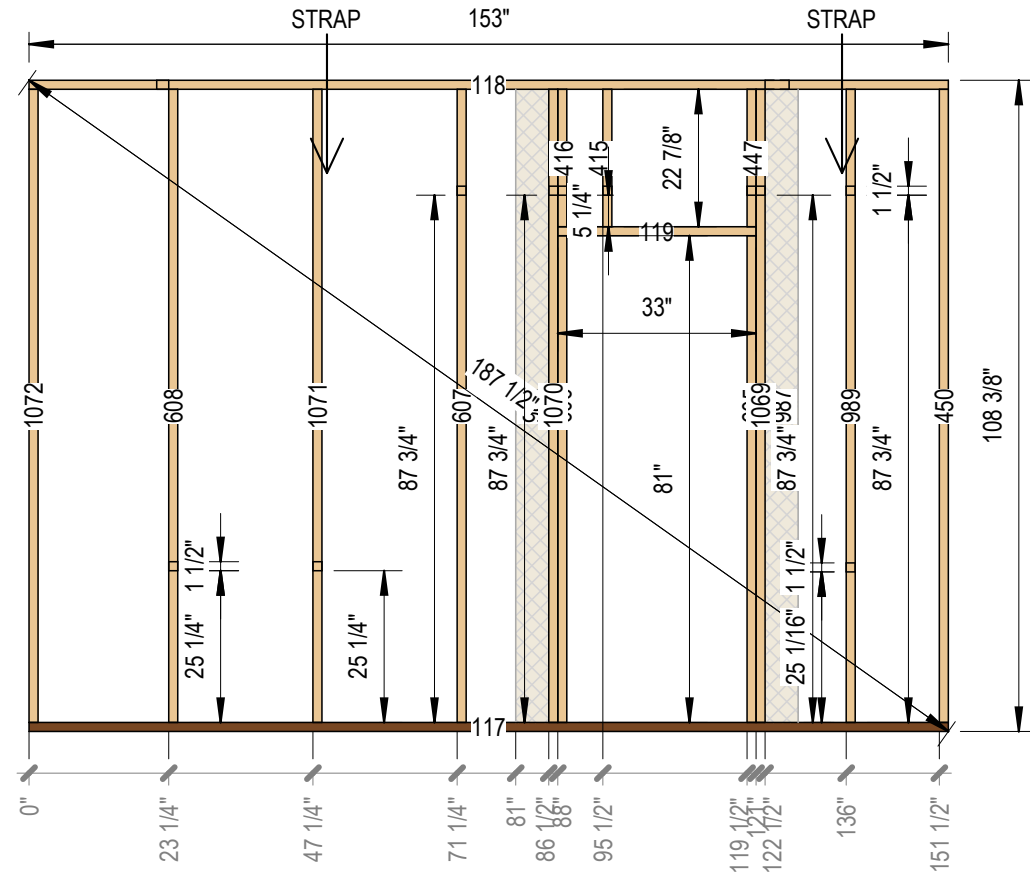

2 Framing Side A
3/8" = 1'-0"

Structural Stud Schedule

Mark	Piece Type	Description	Structural Material	Side	Length
415	HeaderCripple	2x4	SPF #1/#2		22 7/8"
416	HeaderCripple	2x4	SPF #1/#2		22 7/8"
447	HeaderCripple	2x4	SPF #1/#2		22 7/8"
450	Stud	2x4	SPF #1/#2		105 3/8"
605	Trimmer	2x4	SPF #1/#2		81"
606	Trimmer	2x4	SPF #1/#2		81"
607	Stud	2x4	SPF #1/#2		105 3/8"
608	Stud	2x4	SPF #1/#2		105 3/8"
987 - B	FlatStud	2x6	SPF #1/#2	B	105 3/8"
988 - B	FlatStud	2x6	SPF #1/#2	B	105 3/8"
989	Stud	2x4	SPF #1/#2		105 3/8"
1069	KingStud	2x4	SPF #1/#2		105 3/8"
1070	KingStud	2x4	SPF #1/#2		105 3/8"
1071	Stud	2x4	SPF #1/#2		105 3/8"
1072	Stud	2x4	SPF #1/#2		105 3/8"

Structural Connection Schedule

Type	Count	Side
------	-------	------

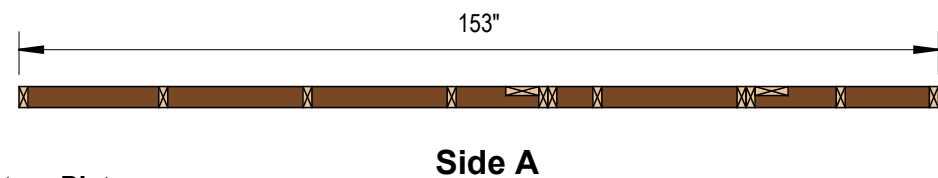

4 Bottom Plate
3/8" = 1'-0"

SUMMERSTONE
1550P
LOT 60
ELEV-B-LEFT

11/7/2025 For Review
NOT FOR CONSTRUCTION

Structural Framing
126.1-TIE

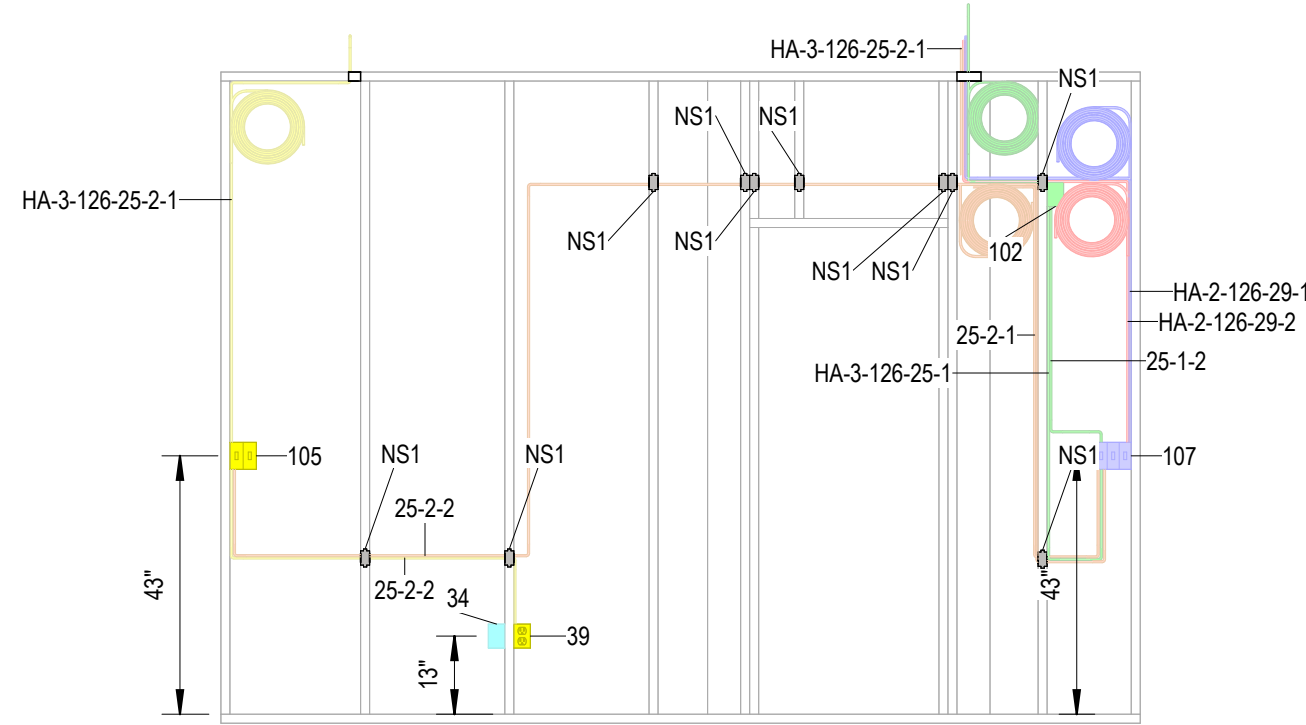

1 Electrical Side A
3/8" = 1'-0"

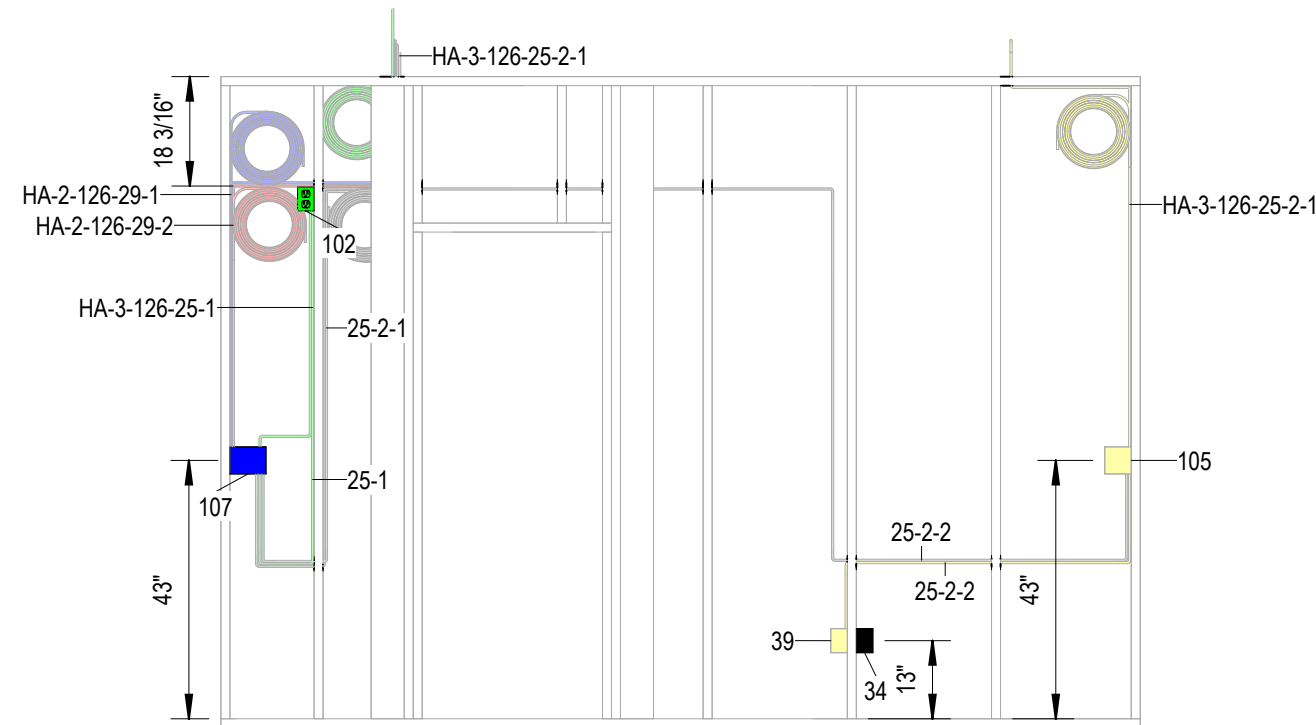

2 Electrical Side B
3/8" = 1'-0"

Mark	Side	Box	Device-A	Device-B	Device-C	Device-D	Comments
34	B	EZ18SNW	Receptacle: T5320W				
39	A	EZ18SNW	Receptacle: T5320W				
102	B	EZ18SNW	Receptacle: T5320W				
105	A	EZ32DN	Standard Switch: 14512W	3-Way Switch: 56032W			
107	B	EZ44TN	Standard Switch: 14512W	4-Way Switch: 5604-SWS	3-Way Switch: 56032W		

Count	Type	Side
10	NS1	A

Prefix-Quadrant-Wall-Circuit-Whip-Index	Type	Total Length	Pull To
HA-2-126-29-1	14/2	41' - 10"	JB2-1
HA-2-126-29-2	14/2	27' - 8"	Ceiling Box 126 & 127
HA-2-126-29-3	14/2	35' - 4"	Electrical Fixtures 22-27
HA-3-126-25-1	<varies>	39' - 1"	JB3-3
HA-3-126-25-1-2	14/2	6' - 3"	
HA-3-126-25-2-1	14/2	51' - 1"	<varies>
HA-3-126-25-2-2	<varies>	35' - 5"	
HA-3-126-25-3	14/2	3' - 6"	JB3-3

SUMMERSTONE
1550P
LOT 60
ELEV-B-LEFT

11/7/2025 For Review	NOT FOR CONSTRUCTION
----------------------	-----------------------------

11/7/2025	For Review					NOT FOR CONSTRUCTION
-----------	------------	--	--	--	--	-----------------------------

1 Top Plate
3/8" = 1'-0"

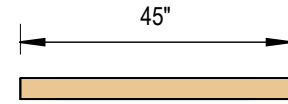

Side A

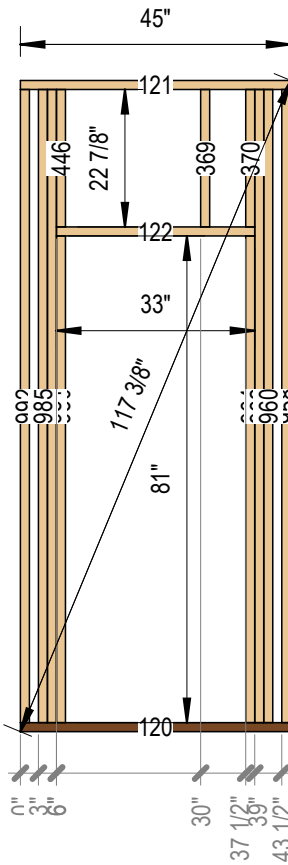

2 Framing Side A
3/8" = 1'-0"

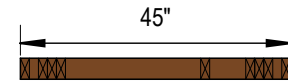

Side A

3 Bottom Plate
3/8" = 1'-0"

Structural Horizontal Framing Schedule

Mark	Piece Type	Description	Structural Material	Side	Cut Length
120	Bottom Plate	2x4	Pressure Treated SPF Standard		45"
121	Top Plate	2x4	SPF #1/#2		45"
122	Header	2x4	SPF #1/#2		33"

Structural Stud Schedule

Mark	Piece Type	Description	Structural Material	Side	Length
369	HeaderCripple	2x4	SPF #1/#2		22 7/8"
370	HeaderCripple	2x4	SPF #1/#2		22 7/8"
446	HeaderCripple	2x4	SPF #1/#2		22 7/8"
958	Stud	2x4	SPF #1/#2		105 3/8"
960	Stud	2x4	SPF #1/#2		105 3/8"
962	KingStud	2x4	SPF #1/#2		105 3/8"
964	Trimmer	2x4	SPF #1/#2		81"
980	Trimmer	2x4	SPF #1/#2		81"
981	KingStud	2x4	SPF #1/#2		105 3/8"
985	KingStud	2x4	SPF #1/#2		105 3/8"
992	Stud	2x4	SPF #1/#2		105 3/8"

Structural Connection Schedule

Type	Count	Side

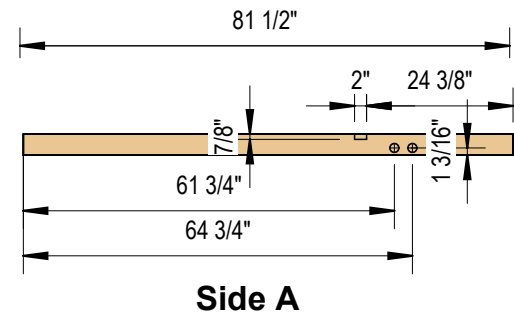

1 Top Plate
3/8" = 1'-0"

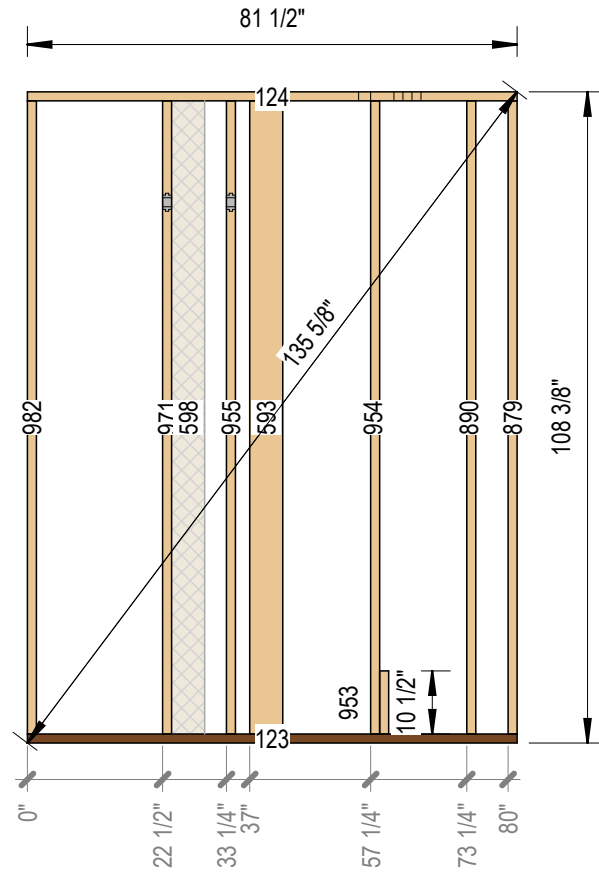

2 Framing Side A
3/8" = 1'-0"

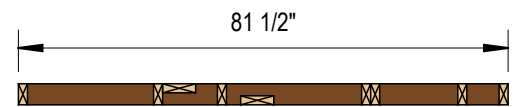

4 Bottom Plate
3/8" = 1'-0"

Side A

Structural Horizontal Framing Schedule

Mark	Piece Type	Description	Structural Material	Side	Cut Length
123	Bottom Plate	2x4	Pressure Treated SPF Standard		81 1/2"
124	Top Plate	2x4	SPF #1/#2		81 1/2"

Structural Stud Schedule

Mark	Piece Type	Description	Structural Material	Side	Length
593 - A	FlatStud	2x6	SPF #1/#2	A	105 3/8"
598 - B	FlatStud	2x6	SPF #1/#2	B	105 3/8"
879	Stud	2x4	SPF #1/#2		105 3/8"
890	Stud	2x4	SPF #1/#2		105 3/8"
953	Stud	2x4	SPF #1/#2		10 1/2"
954	Stud	2x4	SPF #1/#2		105 3/8"
955	Stud	2x4	SPF #1/#2		105 3/8"
971	Stud	2x4	SPF #1/#2		105 3/8"
982	Stud	2x4	SPF #1/#2		105 3/8"

Structural Connection Schedule

Type	Count	Side
NS1	2	

11/7/2025 For Review				NOT FOR CONSTRUCTION

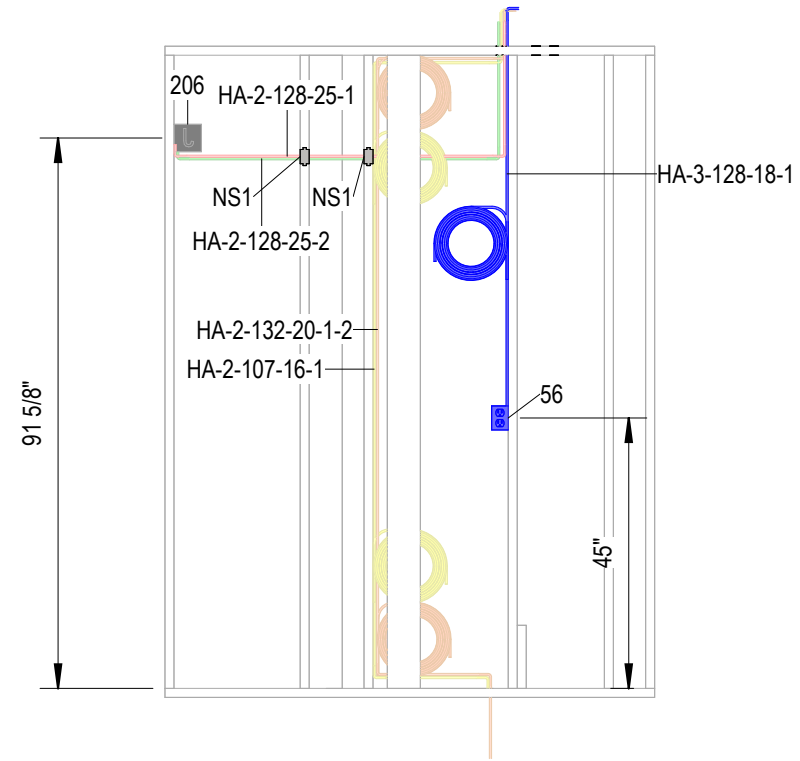

Electrical Fixture Schedule							
Mark	Side	Box	Device-A	Device-B	Device-C	Device-D	Comments
56	A	EZ18SNW	Receptacle: T5320W				Refrigerator
206	B						

Protection Plate Schedule		
Count	Type	Side

Harness Assembly for TIPE-128			
Prefix-Quadrant-Wall-Circuit-Whip-Index	Type	Total Length	Pull To
HA-2-128-25-1	<varies>	21' - 4"	Panel 126, Box 102, Device A
HA-2-128-25-2	<varies>	31' - 1"	Panel 104, Box 205, Device A
HA-3-128-18-1	<varies>	81' - 4"	<varies>

1 Electrical Side A
3/8" = 1'-0"

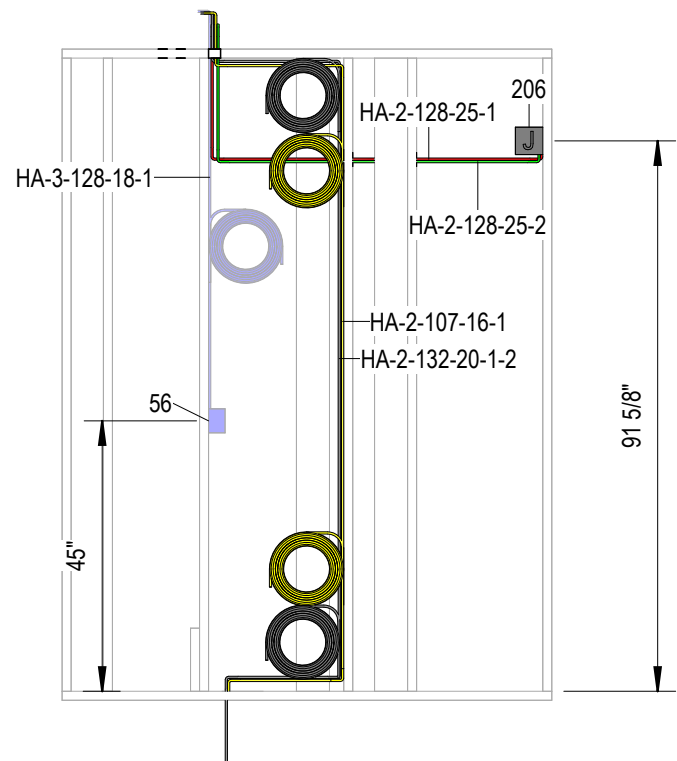

2 Electrical Side B
3/8" = 1'-0"

SUMMERSTONE
1550P
LOT 60
ELEV-B-LEFT

11/7/2025	For Review							NOT FOR CONSTRUCTION
-----------	------------	--	--	--	--	--	--	-----------------------------

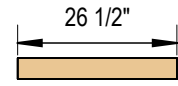

1 Top Plate Side A
3/8" = 1'-0"

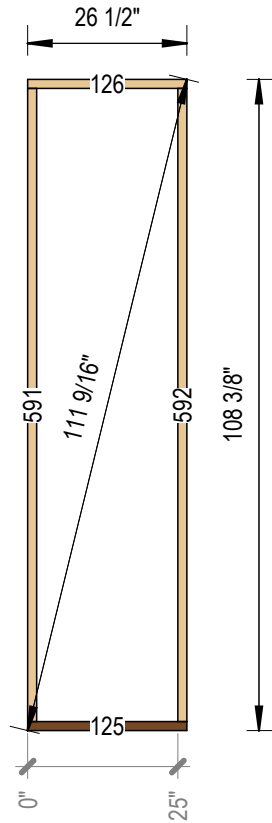

2 Framing Side A
3/8" = 1'-0"

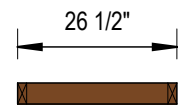

Side A

3 Bottom Plate
3/8" = 1'-0"

Structural Horizontal Framing Schedule

Mark	Piece Type	Description	Structural Material	Side	Cut Length
125	Bottom Plate	2x4	Pressure Treated SPF Standard		26 1/2"
126	Top Plate	2x4	SPF #1/#2		26 1/2"

Structural Stud Schedule

Mark	Piece Type	Description	Structural Material	Side	Length
591	Stud	2x4	SPF #1/#2		105 3/8"
592	Stud	2x4	SPF #1/#2		105 3/8"

Structural Connection Schedule

Type	Count	Side



SUMMERSTONE
1550P
LOT 60
ELEV-B-LEFT

11/7/2025	For Review				NOT FOR CONSTRUCTION

Structural Framing
129.1-TIS

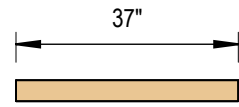

Side A

1 Top Plate
3/8" = 1'-0"

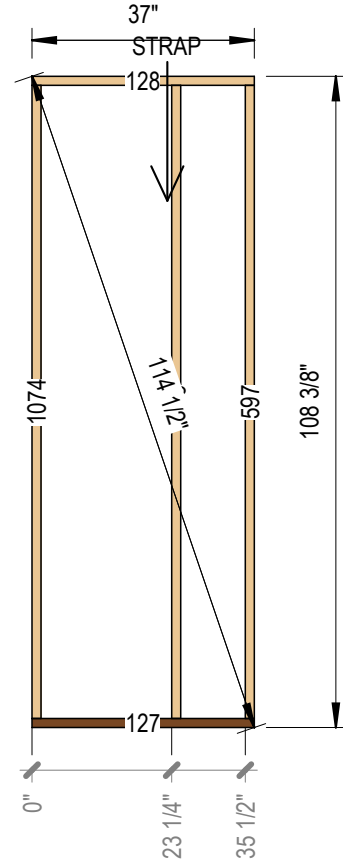

2 Framing Side A
3/8" = 1'-0"

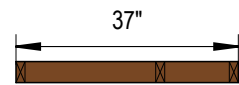

Side A

3 Bottom Plate
3/8" = 1'-0"

Structural Horizontal Framing Schedule

Mark	Piece Type	Description	Structural Material	Side	Cut Length
127	Bottom Plate	2x4	Pressure Treated SPF Standard		37"
128	Top Plate	2x4	SPF #1/#2		37"

Structural Stud Schedule

Mark	Piece Type	Description	Structural Material	Side	Length
597	Stud	2x4	SPF #1/#2		105 3/8"
599	Stud	2x4	SPF #1/#2		105 3/8"
1074	Stud	2x4	SPF #1/#2		105 3/8"

Structural Connection Schedule

Type	Count	Side



SUMMERSTONE
1550P
LOT 60
ELEV-B-LEFT

11/7/2025	For Review				NOT FOR CONSTRUCTION

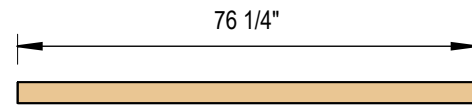

Side A

1 Top Plate
3/8" = 1'-0"

Structural Horizontal Framing Schedule

Mark	Piece Type	Description	Structural Material	Side	Cut Length
129	Bottom Plate	2x4	Pressure Treated SPF Standard		76 1/4"
130	Top Plate	2x4	SPF #1/#2		76 1/4"

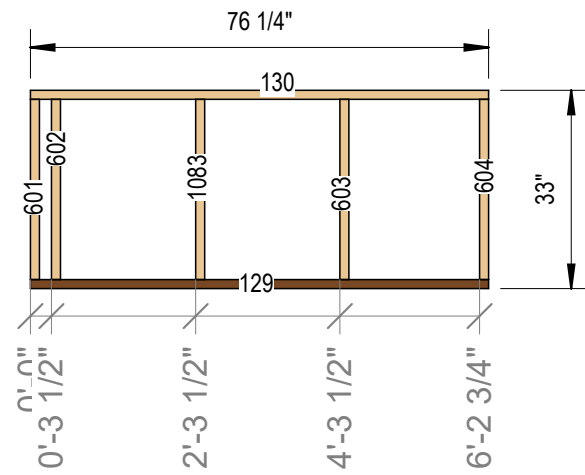

Structural Stud Schedule

Mark	Piece Type	Description	Structural Material	Side	Length
601	Stud	2x4	SPF #1/#2		30"
602	Stud	2x4	SPF #1/#2		30"
603	Stud	2x4	SPF #1/#2		30"
604	Stud	2x4	SPF #1/#2		30"
1081	Stud	2x4	SPF #1/#2		30"

4 Framing Side A
3/8" = 1'-0"



Side A

Structural Connection Schedule

Type	Count	Side
------	-------	------

5 Elevation Top
3/8" = 1'-0"

11/7/2025 For Review					NOT FOR CONSTRUCTION

11/7/2025	For Review								NOT FOR CONSTRUCTION
-----------	------------	--	--	--	--	--	--	--	-----------------------------

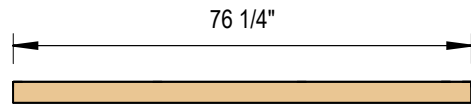

Side A

1 Top Plate
3/8" = 1'-0"

Mark	Piece Type	Description	Structural Material	Side	Cut Length
131	Bottom Plate	2x4	Pressure Treated SPF Standard		76 1/4"
132	Top Plate	2x4	SPF #1/#2		76 1/4"

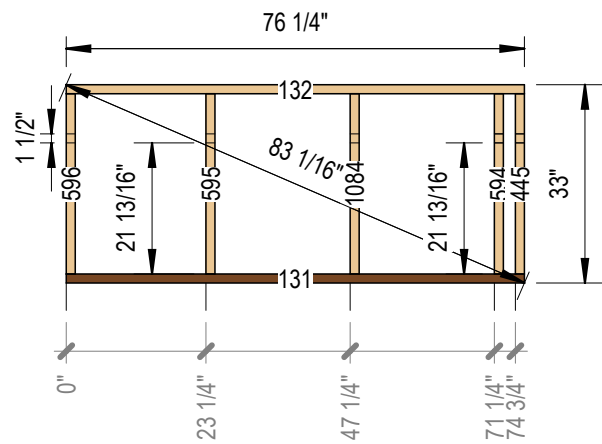

2 Framing Side A
3/8" = 1'-0"

Mark	Piece Type	Description	Structural Material	Side	Length
445	Stud	2x4	SPF #1/#2		30"
594	Stud	2x4	SPF #1/#2		30"
595	Stud	2x4	SPF #1/#2		30"
596	Stud	2x4	SPF #1/#2		30"
1084	Stud	2x4	SPF #1/#2		30"

Type	Count	Side
------	-------	------

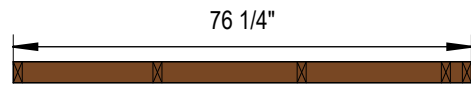

Side A

3 Bottom Plate
3/8" = 1'-0"



Side A

1 Top Plate
3/8" = 1'-0"

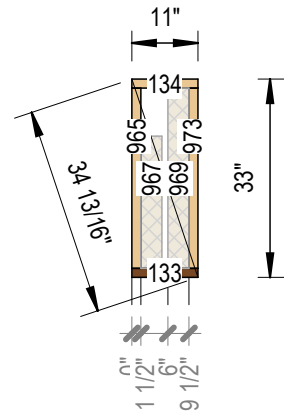

2 Framing Side A
3/8" = 1'-0"

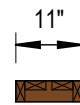

Side A

3 Bottom Plate
3/8" = 1'-0"

Structural Horizontal Framing Schedule

Mark	Piece Type	Description	Structural Material	Side	Cut Length
133	Bottom Plate	2x4	Pressure Treated SPF Standard		11"
134	Top Plate	2x4	SPF #1/#2		11"

Structural Stud Schedule

Mark	Piece Type	Description	Structural Material	Side	Length
965	Stud	2x4	SPF #1/#2		30"
967 - B	FlatStud	2x4	SPF #1/#2	B	22"
969 - B	FlatStud	2x4	SPF #1/#2	B	30"
973	Stud	2x4	SPF #1/#2		30"

Structural Connection Schedule

Type	Count	Side



SUMMERSTONE
1550P
LOT 60
ELEV-B-LEFT

11/7/2025 For Review					NOT FOR CONSTRUCTION

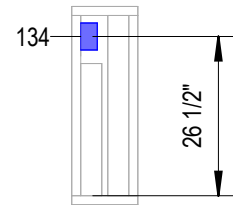

1 Electrical Side A
3/8" = 1'-0"

Electrical Fixture Schedule							
Mark	Side	Box	Device-A	Device-B	Device-C	Device-D	Comments
134	A	EZ21SBZ-ADJ	Receptacle: Leviton T5632W				

Protection Plate Schedule		
Count	Type	Side

Harness Assembly for 133-TIS			
Prefix-Quadrant-Wall-Circuit-Whip-Index	Type	Total Length	Pull To

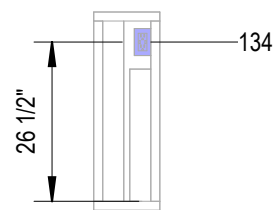

2 Electrical Side B
3/8" = 1'-0"

SUMMERSTONE
1550P
LOT 60
ELEV-B-LEFT

11/7/2025	For Review						NOT FOR CONSTRUCTION
-----------	------------	--	--	--	--	--	-----------------------------



Side A

1 Top Plate
3/8" = 1'-0"

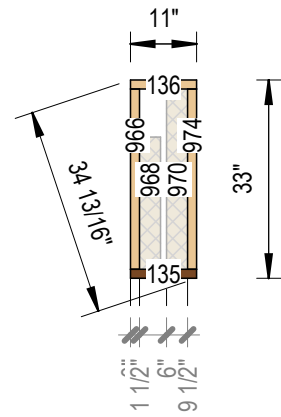

2 Framing Side A
3/8" = 1'-0"

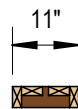

Side A

4 Bottom Plate
3/8" = 1'-0"

Structural Horizontal Framing Schedule

Mark	Piece Type	Description	Structural Material	Side	Cut Length
135	Bottom Plate	2x4	Pressure Treated SPF Standard		11"
136	Top Plate	2x4	SPF #1/#2		11"

Structural Stud Schedule

Mark	Piece Type	Description	Structural Material	Side	Length
966	Stud	2x4	SPF #1/#2		30"
968 - B	FlatStud	2x4	SPF #1/#2	B	22"
970 - B	FlatStud	2x4	SPF #1/#2	B	30"
974	Stud	2x4	SPF #1/#2		30"

Structural Connection Schedule

Type	Count	Side
------	-------	------

11/7/2025 For Review					NOT FOR CONSTRUCTION

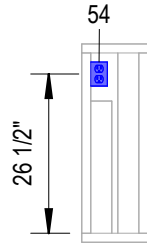

1 Electrical Side A
3/8" = 1'-0"



2 Electrical Side B
3/8" = 1'-0"

Electrical Fixture Schedule							
Mark	Side	Box	Device-A	Device-B	Device-C	Device-D	Comments
54	A	EZ18SNW	Receptacle: T5320W				Island

Protection Plate Schedule		
Count	Type	Side

Harness Assembly for TIE-134			
Prefix-Quadrant-Wall-Circuit-Whip-Index	Type	Total Length	Pull To

SUMMERSTONE
1550P
LOT 60
ELEV-B-LEFT

11/7/2025	For Review							NOT FOR CONSTRUCTION
-----------	------------	--	--	--	--	--	--	-----------------------------

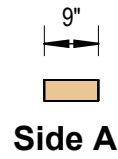

Side A

1 Top Plate
3/8" = 1'-0"

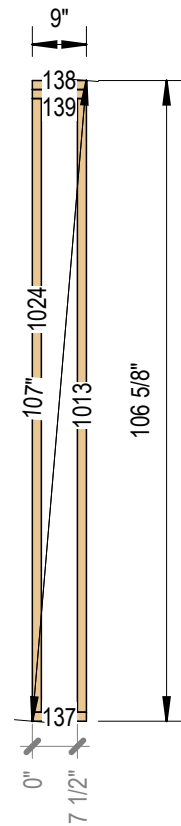

2 Framing Elevation
3/8" = 1'-0"

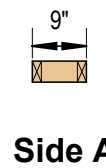

Side A

3 Bottom Plate
3/8" = 1'-0"

Structural Horizontal Framing Schedule

Mark	Piece Type	Description	Structural Material	Side	Cut Length
137	Bottom Plate	2x4	SPF #1/#2		9"
138	Top Plate	2x4	SPF #1/#2		9"
139	Top Plate	2x4	SPF #1/#2		9"

Structural Stud Schedule

Mark	Piece Type	Description	Structural Material	Side	Length
1013	Stud	2x4	SPF #1/#2		102 1/8"
1024	Stud	2x4	SPF #1/#2		102 1/8"

Structural Connection Schedule

Type	Count	Side



SUMMERSTONE
1550P
LOT 60
ELEV-B-LEFT

11/7/2025 For Review					NOT FOR CONSTRUCTION

Structural Framing
135.1-TES

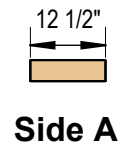

1 Top Plate
3/8" = 1'-0"

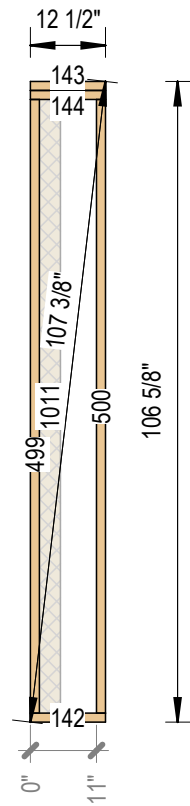

2 Framing Side A
3/8" = 1'-0"

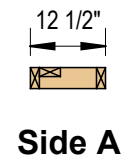

4 Bottom Plate
3/8" = 1'-0"

Structural Horizontal Framing Schedule

Mark	Piece Type	Description	Structural Material	Side	Cut Length
142	Bottom Plate	2x4	SPF #1/#2		12 1/2"
143	Top Plate	2x4	SPF #1/#2		12 1/2"
144	Top Plate	2x4	SPF #1/#2		12 1/2"

Structural Stud Schedule

Mark	Piece Type	Description	Structural Material	Side	Length
499	Stud	2x4	SPF #1/#2		102 1/8"
500	Stud	2x4	SPF #1/#2		102 1/8"
1011	Stud	2x4	SPF #1/#2	B	102 1/8"

Structural Connection Schedule

Type	Count	Side

SUMMERSTONE
1550P
LOT 60
ELEV-B-LEFT

11/7/2025	For Review				NOT FOR CONSTRUCTION

1 Top Plate
3/8" = 1'-0"

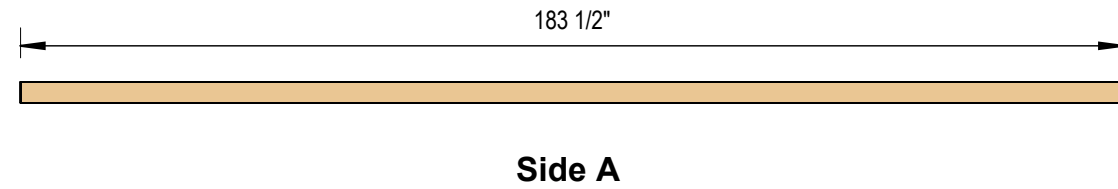

Structural Horizontal Framing Schedule					
Mark	Piece Type	Description	Structural Material	Side	Cut Length
147	Bottom Plate	2x4	SPF #1/#2		183 1/2"
148	Top Plate	2x4	SPF #1/#2		183 1/2"
149	Top Plate	2x4	SPF #1/#2		183 1/2"
150	Temporary	3x4	SPF Standard		12"
151	Temporary	3x4	SPF Standard		12"
152	Temporary	2x4	SPF Standard		12"
153	Temporary	2x4	SPF Standard		12"

2 Framing Side A
3/8" = 1'-0"

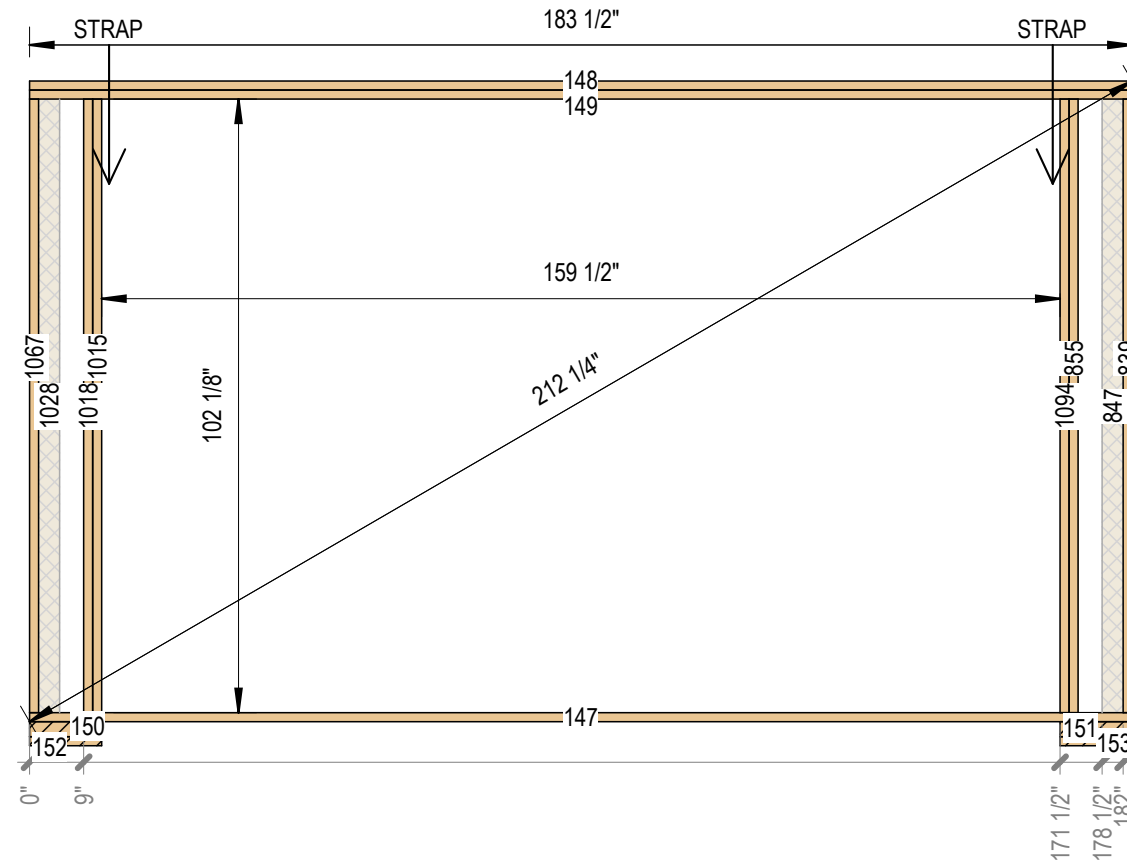

Structural Stud Schedule					
Mark	Piece Type	Description	Structural Material	Side	Length
839	Stud	2x4	SPF #1/#2		102 1/8"
847 - B	FlatStud	2x4	SPF #1/#2	B	102 1/8"
855	KingStud	2x4	SPF #1/#2		102 1/8"
1015	Trimmer	2x4	SPF #1/#2		102 1/8"
1018	KingStud	2x4	SPF #1/#2		102 1/8"
1028 - B	FlatStud	2x4	SPF #1/#2	B	102 1/8"
1067	Stud	2x4	SPF #1/#2		102 1/8"
1094	Trimmer	2x4	SPF #1/#2		102 1/8"

4 Bottom Plate
3/8" = 1'-0"

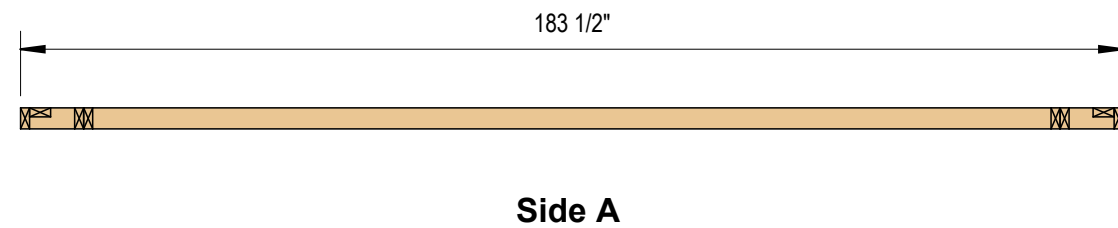

Structural Connection Schedule		
Type	Count	Side

SUMMERSTONE
1550P
LOT 60
ELEV-B-LEFT

11/7/2025 For Review				NOT FOR CONSTRUCTION

Structural Framing
137.1-TES

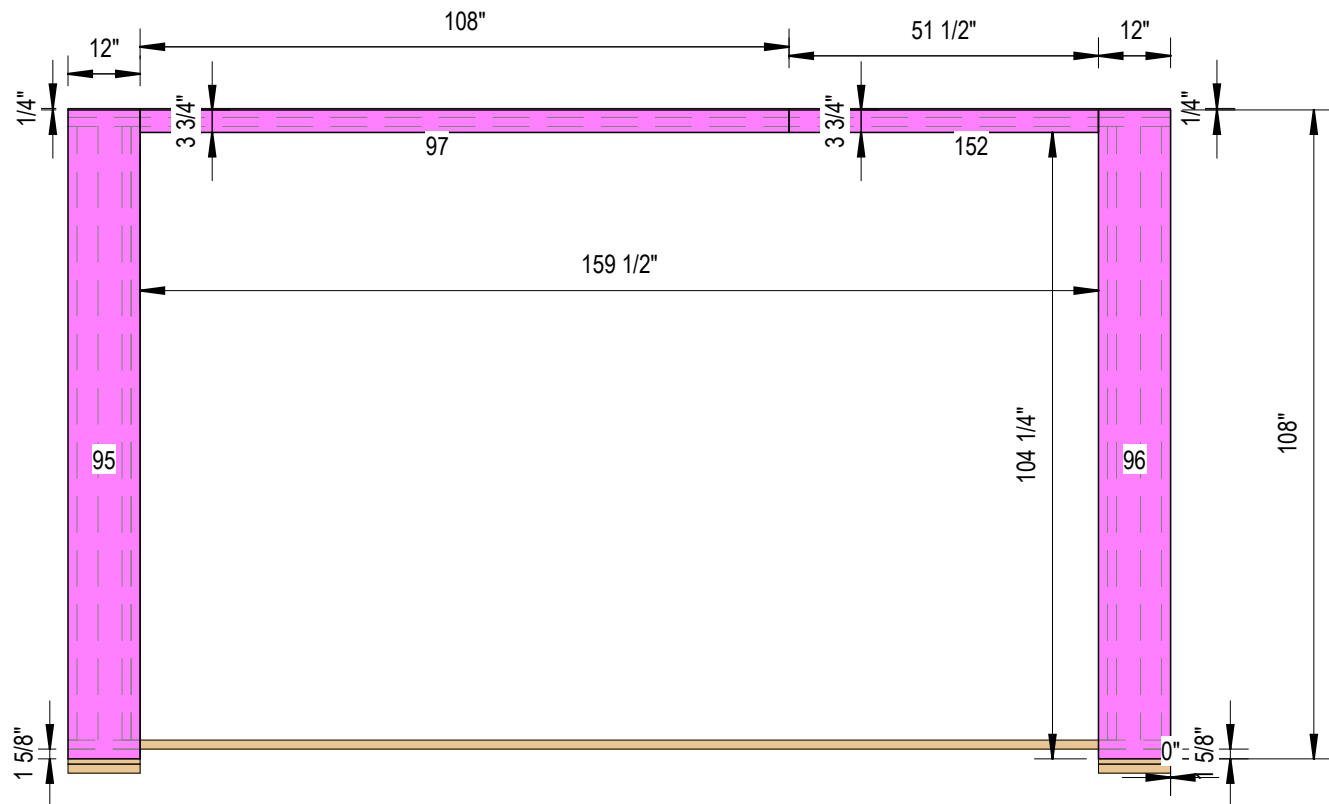

1 Sheathing Side A
3/8" = 1'-0"

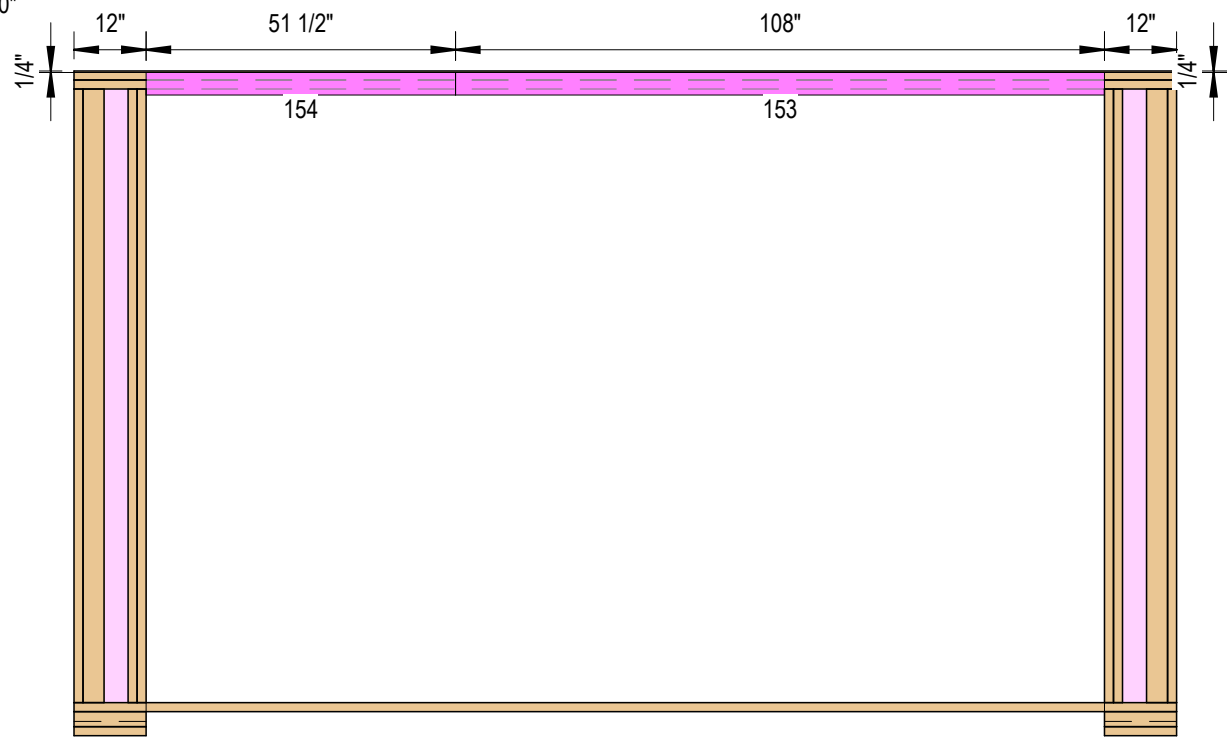

2 Sheathing Side B
3/8" = 1'-0"

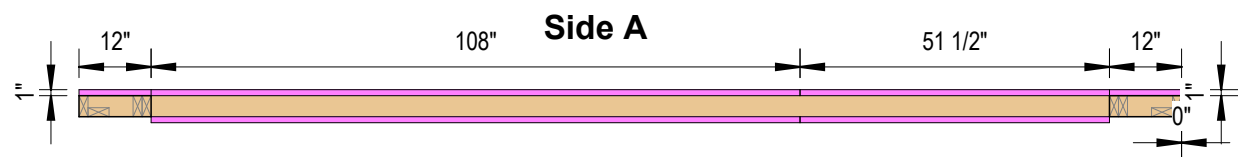

3 Sheathing Bottom View
3/8" = 1'-0"

Vertical Wall Sheathing Schedule

Mark	Description	Thickness	Length	Height
95	Picasso	1"	12"	108"
96	Picasso	1"	12"	108"
97	Picasso	1"	108"	3 3/4"
152	Picasso	1"	51 1/2"	3 3/4"
153	Picasso	1"	108"	3 3/4"
154	Picasso	1"	51 1/2"	3 3/4"

Horizontal Sheathing Schedule

Mark	Description	Thickness	Length	Width
------	-------------	-----------	--------	-------

11/7/2025	For Review					NOT FOR CONSTRUCTION

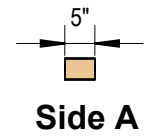

Side A

1 Top Plate
3/8" = 1'-0"

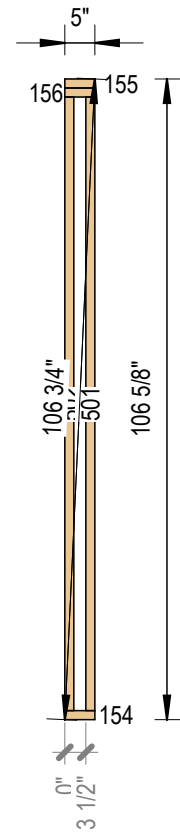

2 Framing Side A
3/8" = 1'-0"

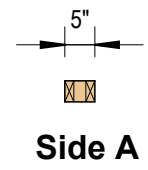

Side A

3 Bottom Plate
3/8" = 1'-0"

Structural Horizontal Framing Schedule

Mark	Piece Type	Description	Structural Material	Side	Cut Length
154	Bottom Plate	2x4	SPF #1/#2		5"
155	Top Plate	2x4	SPF #1/#2		5"
156	Top Plate	2x4	SPF #1/#2		5"

Structural Stud Schedule

Mark	Piece Type	Description	Structural Material	Side	Length
501	Stud	2x4	SPF #1/#2		102 1/8"
502	Stud	2x4	SPF #1/#2		102 1/8"

Structural Connection Schedule

Type	Count	Side
------	-------	------



SUMMERSTONE
1550P
LOT 60
ELEV-B-LEFT

11/7/2025 For Review					NOT FOR CONSTRUCTION



Side A

1 Top Plate
3/8" = 1'-0"

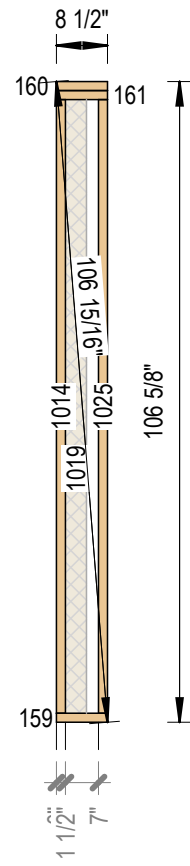

2 Framing Side A
3/8" = 1'-0"



Side A

4 Bottom Plate
3/8" = 1'-0"

Structural Horizontal Framing Schedule

Mark	Piece Type	Description	Structural Material	Side	Cut Length
159	Bottom Plate	2x4	SPF #1/#2		8 1/2"
160	Top Plate	2x4	SPF #1/#2		8 1/2"
161	Top Plate	2x4	SPF #1/#2		8 1/2"

Structural Stud Schedule

Mark	Piece Type	Description	Structural Material	Side	Length
1014	Stud	2x4	SPF #1/#2		102 1/8"
1019 - B	FlatStud	2x4	SPF #1/#2	B	102 1/8"
1025	Stud	2x4	SPF #1/#2		102 1/8"

Structural Connection Schedule

Type	Count	Side
------	-------	------

11/7/2025 For Review					NOT FOR CONSTRUCTION

11/7/2025	For Review							NOT FOR CONSTRUCTION
-----------	------------	--	--	--	--	--	--	-----------------------------



Side A

1 Top Plate
3/8" = 1'-0"

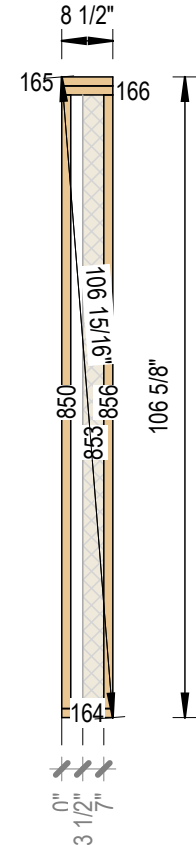

2 Framing Side A
3/8" = 1'-0"



Side A

4 Bottom Plate
3/8" = 1'-0"

Structural Horizontal Framing Schedule

Mark	Piece Type	Description	Structural Material	Side	Cut Length
164	Bottom Plate	2x4	SPF #1/#2		8 1/2"
165	Top Plate	2x4	SPF #1/#2		8 1/2"
166	Top Plate	2x4	SPF #1/#2		8 1/2"

Structural Stud Schedule

Mark	Piece Type	Description	Structural Material	Side	Length
850	Stud	2x4	SPF #1/#2		102 1/8"
853 - B	FlatStud	2x4	SPF #1/#2	B	102 1/8"
856	Stud	2x4	SPF #1/#2		102 1/8"

Structural Connection Schedule

Type	Count	Side

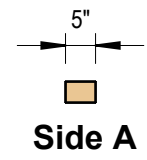

Side A

1 Top Plate
3/8" = 1'-0"

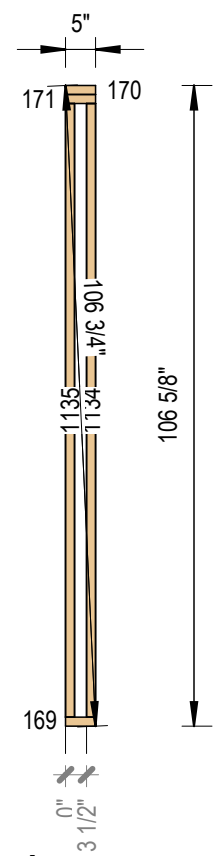

2 Framing Side A
3/8" = 1'-0"

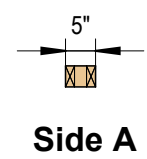

Side A

3 Bottom Plate
3/8" = 1'-0"

Structural Horizontal Framing Schedule

Mark	Piece Type	Description	Structural Material	Side	Cut Length
169	Bottom Plate	2x4	SPF #1/#2		5"
170	Top Plate	2x4	SPF #1/#2		5"
171	Top Plate	2x4	SPF #1/#2		5"

Structural Stud Schedule

Mark	Piece Type	Description	Structural Material	Side	Length
492	Stud	2x4	SPF #1/#2		102 1/8"
493	Stud	2x4	SPF #1/#2		102 1/8"
1134	Stud	2x4	SPF #1/#2		102 1/8"
1135	Stud	2x4	SPF #1/#2		102 1/8"

Structural Connection Schedule

Type	Count	Side



SUMMERSTONE
1550P
LOT 60
ELEV-B-LEFT

11/7/2025 For Review					NOT FOR CONSTRUCTION

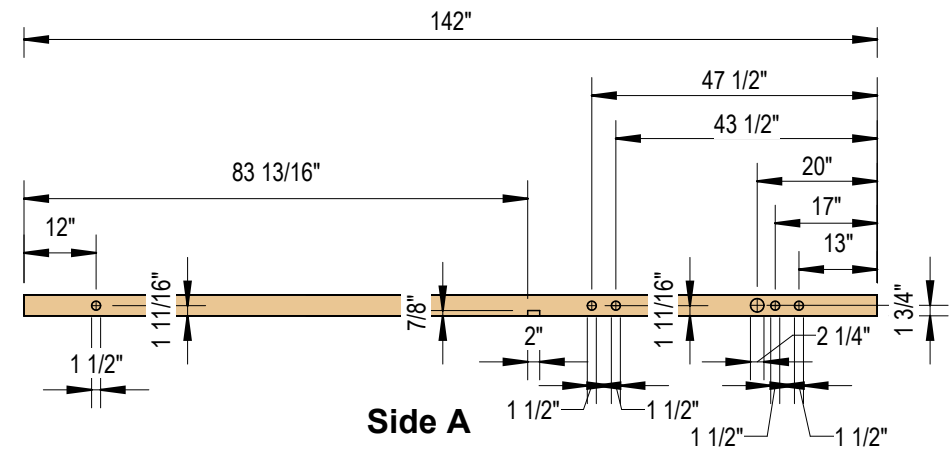

Side A

1 Top Plate
3/8" = 1'-0"

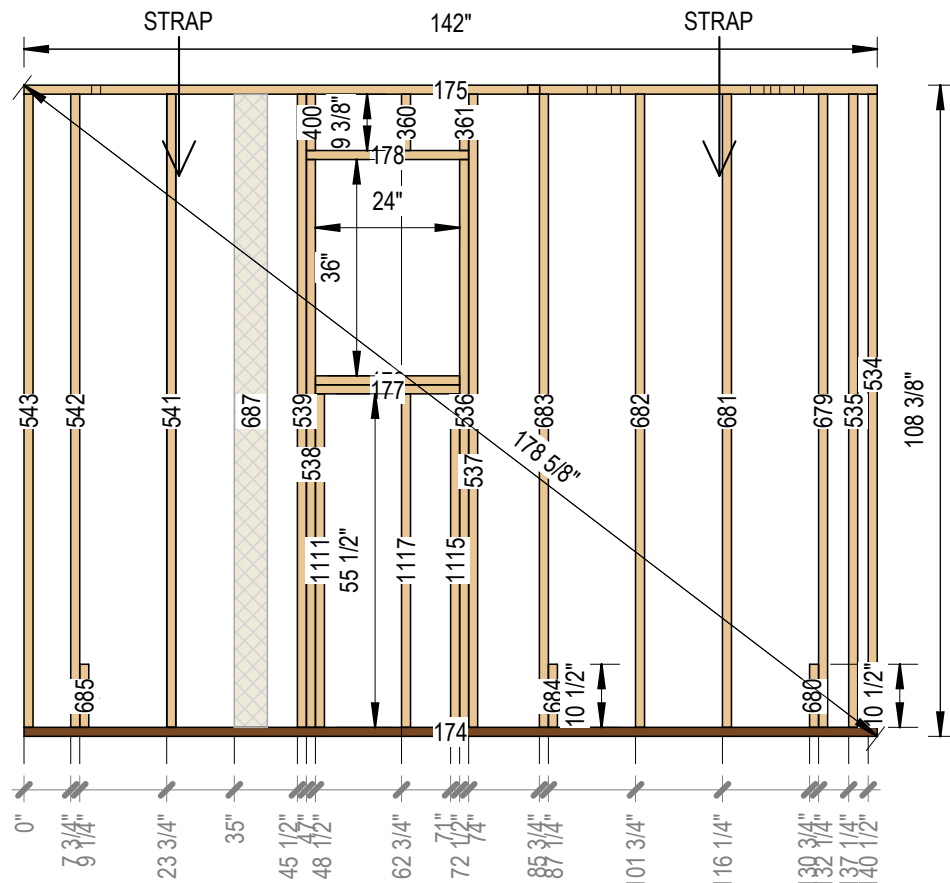

Side A

2 Framing Side A
3/8" = 1'-0"

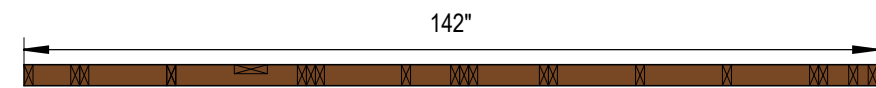

3 Bottom Plate
3/8" = 1'-0"

Structural Horizontal Framing Schedule

Mark	Piece Type	Description	Structural Material	Side	Cut Length
174	Bottom Plate	2x4	Pressure Treated SPF Standard		142"
175	Top Plate	2x4	SPF #1/#2		142"
176	Sill	2x4	SPF #1/#2		24"
177	Sill	2x4	SPF #1/#2		24"
178	Header	2x4	SPF #1/#2		27"

Structural Stud Schedule

Mark	Piece Type	Description	Structural Material	Side	Length
360	HeaderCripple	2x4	SPF #1/#2		9 3/8"
361	HeaderCripple	2x4	SPF #1/#2		9 3/8"
400	HeaderCripple	2x4	SPF #1/#2		9 3/8"
534	Stud	2x4	SPF #1/#2		105 3/8"
535	Stud	2x4	SPF #1/#2		105 3/8"
536	Trimmer	2x4	SPF #1/#2		94 1/2"
537	KingStud	2x4	SPF #1/#2		105 3/8"
538	Trimmer	2x4	SPF #1/#2		94 1/2"
539	KingStud	2x4	SPF #1/#2		105 3/8"
540	Stud	2x4	SPF #1/#2		105 3/8"
541	Stud	2x4	SPF #1/#2		105 3/8"
542	Stud	2x4	SPF #1/#2		105 3/8"
543	Stud	2x4	SPF #1/#2		105 3/8"
679	Stud	2x4	SPF #1/#2		105 3/8"
680	Stud	2x4	SPF #1/#2		10 1/2"
681	Stud	2x4	SPF #1/#2		105 3/8"
682	Stud	2x4	SPF #1/#2		105 3/8"
683	Stud	2x4	SPF #1/#2		105 3/8"
684	Stud	2x4	SPF #1/#2		10 1/2"
685	Stud	2x4	SPF #1/#2		10 1/2"
687 - B	FlatStud	2x6	SPF #1/#2	B	105 3/8"
1111	SillCripple	2x4	SPF #1/#2		55 1/2"
1115	SillCripple	2x4	SPF #1/#2		55 1/2"
1117	SillCripple	2x4	SPF #1/#2		55 1/2"

Structural Connection Schedule

Type	Count	Side
------	-------	------

11/7/2025	For Review	NOT FOR CONSTRUCTION

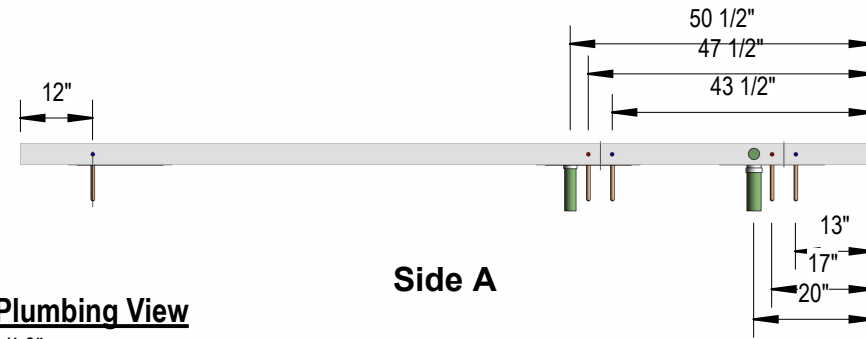

1 Top Plumbing View
3/8" = 1'-0"

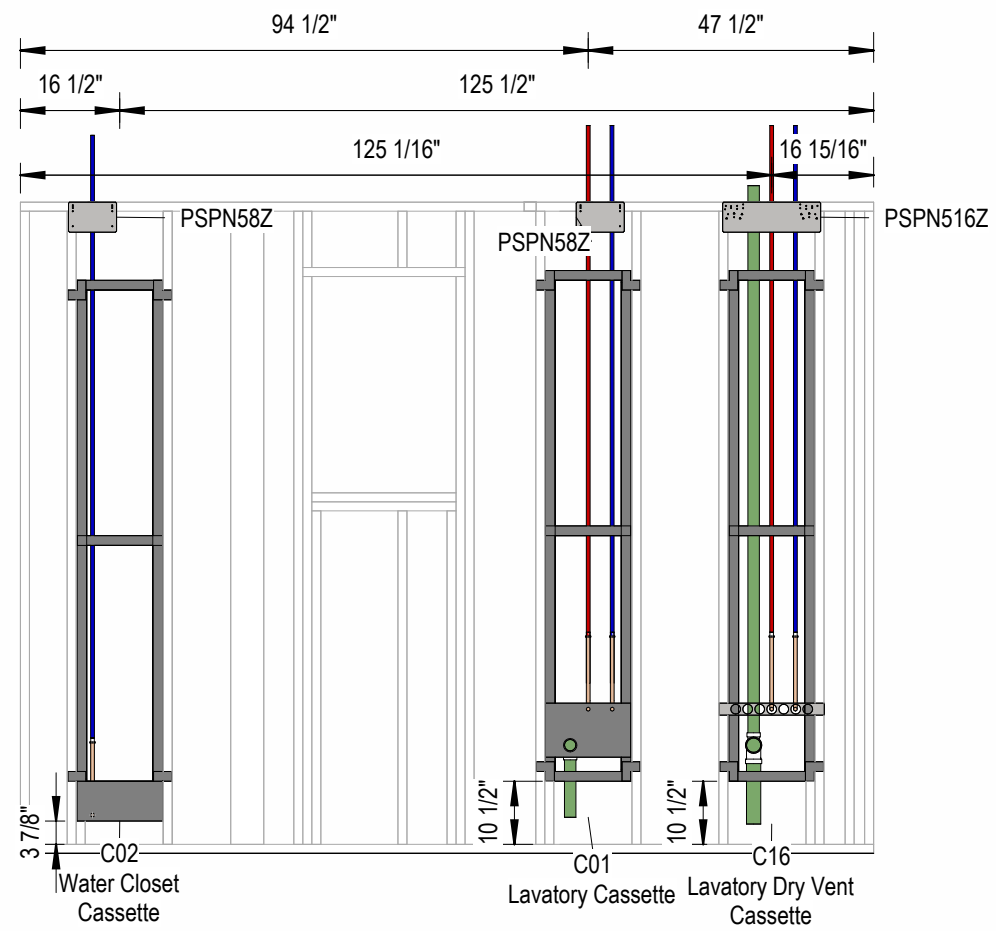

2 Plumbing Side A
3/8" = 1'-0"

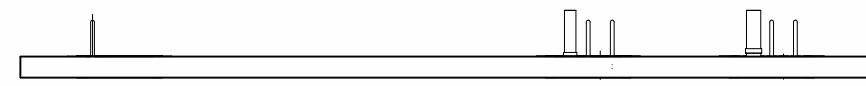

3 Bottom Plumbing View
3/8" = 1'-0"

Cassette ID	Type	.Side
C16	Lavatory Dry Vent Cassette	
C01	Lavatory Cassette	
C02	Water Closet Cassette	

Count	Type	Side
2	PSPN58Z	A
1	PSPN516Z	A

SUMMERSTONE
1550P
LOT 60
ELEV-B-LEFT

11/7/2025 For Review					NOT FOR CONSTRUCTION

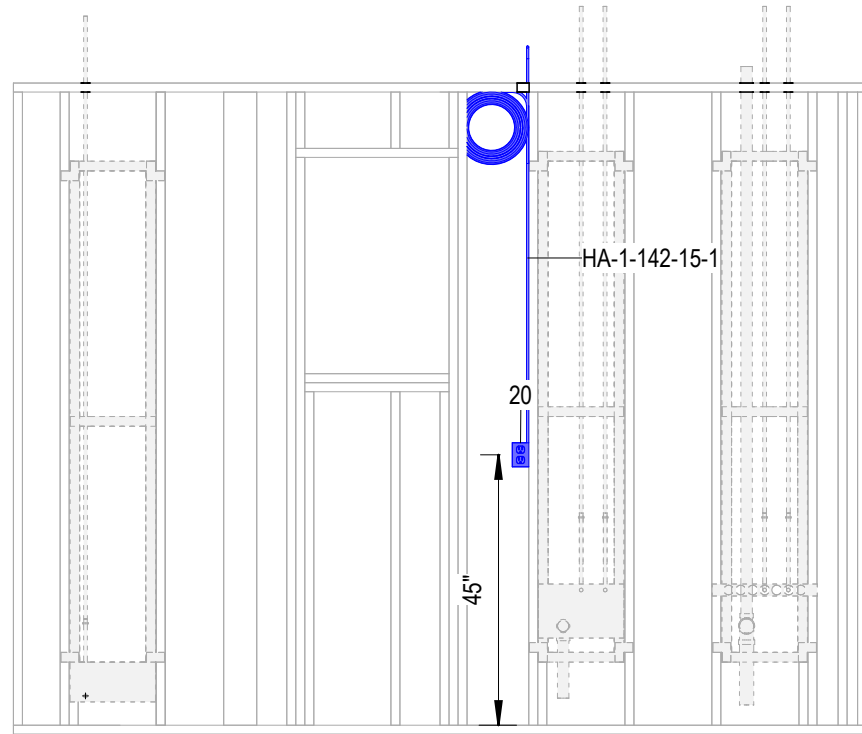

Electrical Fixture Schedule							
Mark	Side	Box	Device-A	Device-B	Device-C	Device-D	Comments
20	A	EZ18SNW	Receptacle: T5320W				Bath Counter

Protection Plate Schedule		
Count	Type	Side

Harness Assembly for TIPE-142			
Prefix-Quadrant-Wall-Circuit-Whip-Index	Type	Total Length	Pull To
HA-1-142-15-1	12/2	35' - 0"	JB1-1

SUMMERSTONE
1550P
 LOT 60
 ELEV-B-LEFT

1 Electrical Side A
 3/8" = 1'-0"

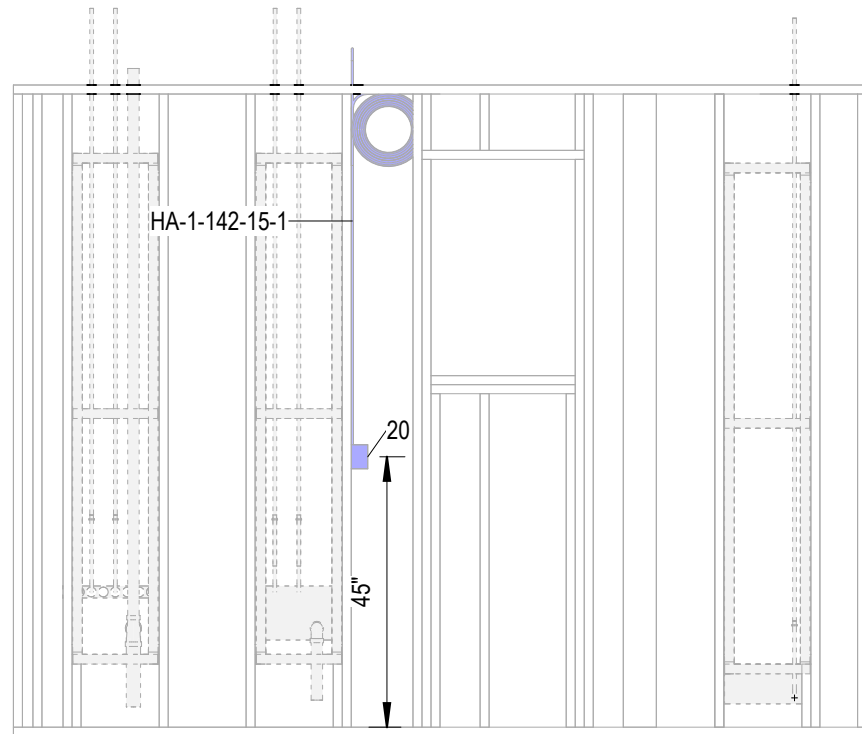

2 Electrical Side B
 3/8" = 1'-0"

11/7/2025	For Review	NOT FOR CONSTRUCTION

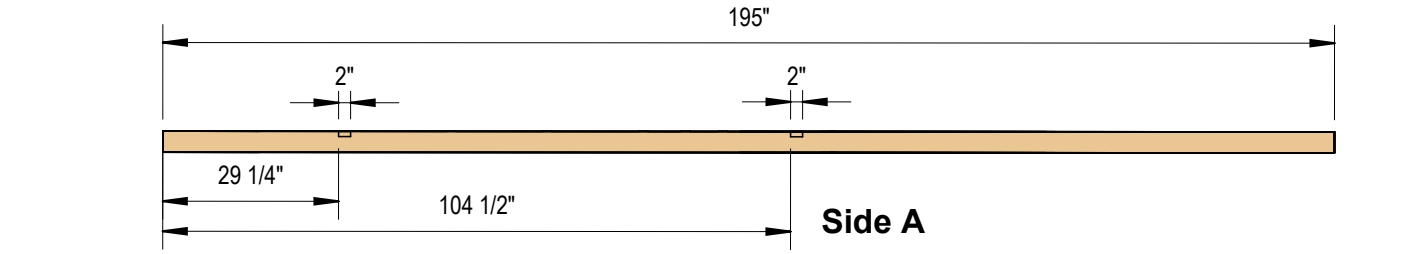

1 Top Plate
3/8" = 1'-0"

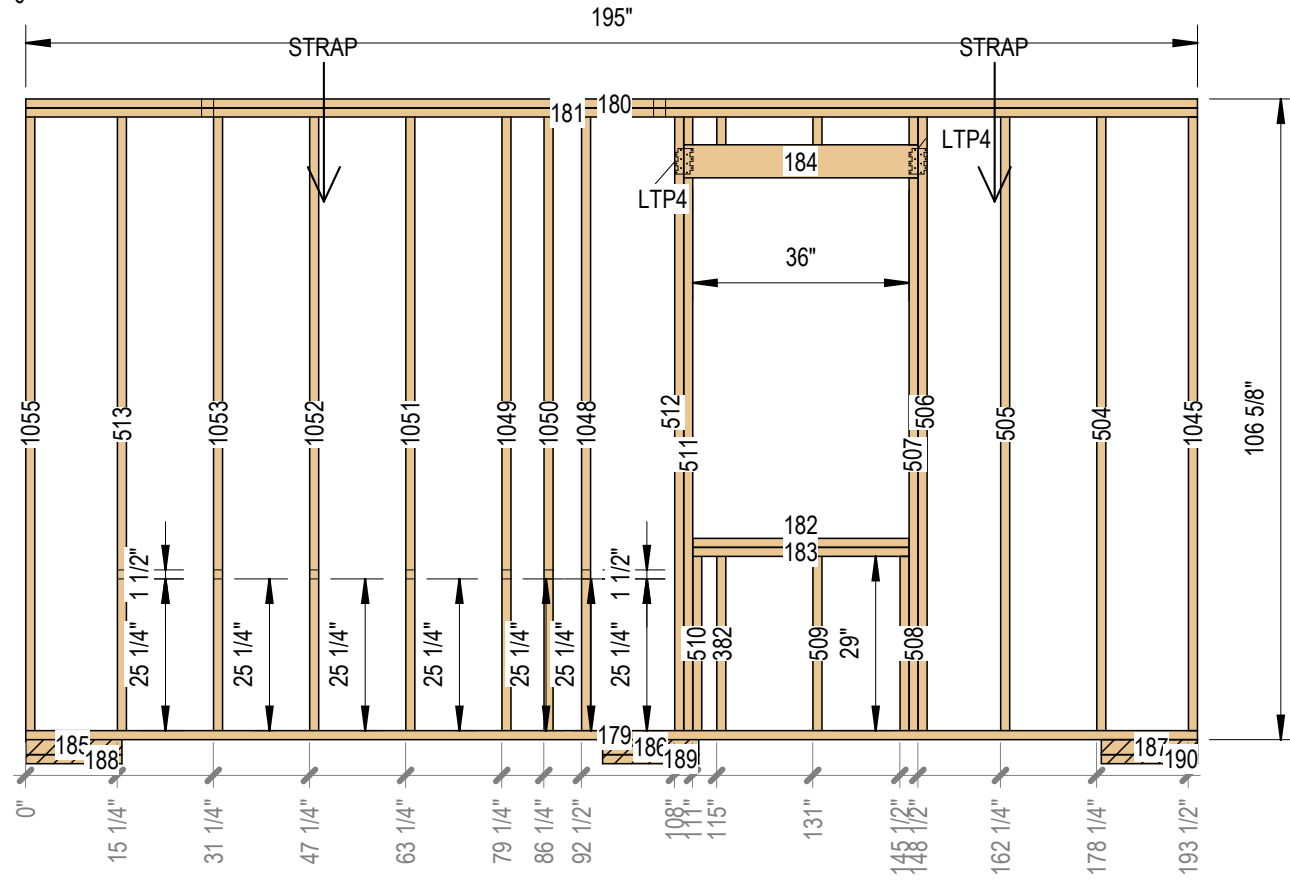

2 Framing Side A
3/8" = 1'-0"

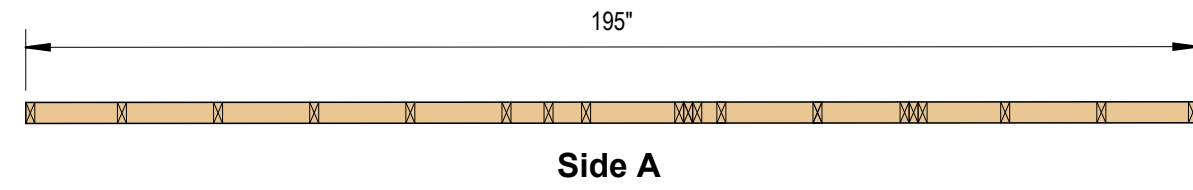

3 Bottom Plate
3/8" = 1'-0"

Structural Horizontal Framing Schedule					
Mark	Piece Type	Description	Structural Material	Side	Cut Length
179	Bottom Plate	2x4	SPF #1/#2		195"
180	Top Plate	2x4	SPF #1/#2		195"
181	Top Plate	2x4	SPF #1/#2		195"
182	Sill	2x4	SPF #1/#2		36 1/256"
183	Sill	2x4	SPF #1/#2		36 1/256"
184	Header	4x6	DF #2		39 1/256"
185	Temporary	3x4	SPF Standard		16"
186	Temporary	3x4	SPF Standard		16"
187	Temporary	3x4	SPF Standard		16"
188	Temporary	2x4	SPF Standard		16"
189	Temporary	2x4	SPF Standard		16"
190	Temporary	2x4	SPF Standard		16"

Structural Stud Schedule					
Mark	Piece Type	Description	Structural Material	Side	Length
	KingStud	2x4	SPF #1/#2		4 5/8"
	KingStud	2x4	SPF #1/#2		4 5/8"
	KingStud	2x4	SPF #1/#2		4 5/8"
	KingStud	2x4	SPF #1/#2		4 5/8"
382	SillCripple	2x4	SPF #1/#2		29"
504	Stud	2x4	SPF #1/#2		102 1/8"
505	Stud	2x4	SPF #1/#2		102 1/8"
506	KingStud	2x4	SPF #1/#2		102 1/8"
507	Trimmer	2x4	SPF #1/#2		92"
508	SillCripple	2x4	SPF #1/#2		29"
509	SillCripple	2x4	SPF #1/#2		29"
510	SillCripple	2x4	SPF #1/#2		29"
511	Trimmer	2x4	SPF #1/#2		92"
512	KingStud	2x4	SPF #1/#2		102 1/8"
513	Stud	2x4	SPF #1/#2		102 1/8"
1045	Stud	2x4	SPF #1/#2		102 1/8"
1048	Stud	2x4	SPF #1/#2		102 1/8"
1049	Stud	2x4	SPF #1/#2		102 1/8"
1050	Stud	2x4	SPF #1/#2		102 1/8"
1051	Stud	2x4	SPF #1/#2		102 1/8"
1052	Stud	2x4	SPF #1/#2		102 1/8"
1053	Stud	2x4	SPF #1/#2		102 1/8"
1055	Stud	2x4	SPF #1/#2		102 1/8"

Structural Connection Schedule		
Type	Count	Side
LTP4	2	B

Vertical Wall Sheathing Schedule				
Mark	Description	Thickness	Length	Height
67	Picasso	1"	39"	33 5/8"
99	Picasso	1"	48"	108"
100	Picasso	1"	22 1/2"	108"
101	Picasso	1"	46 1/2"	108"
102	Picasso	1"	39"	11 3/8"
155	Picasso	1"	39"	108"

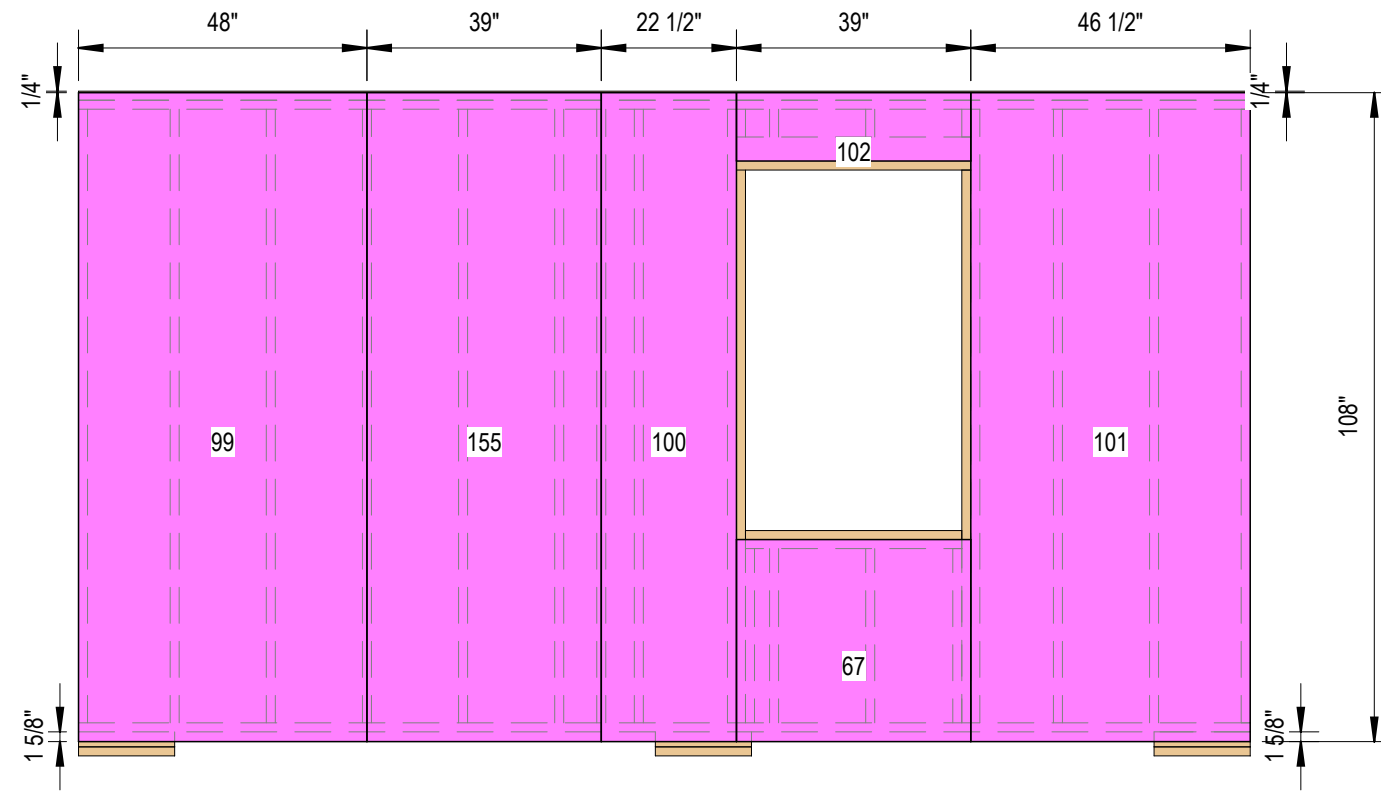

1 Sheathing Side A
3/8" = 1'-0"

SUMMERSTONE
1550P
LOT 60
ELEV-B-LEFT

11/7/2025	For Review	NOT FOR CONSTRUCTION

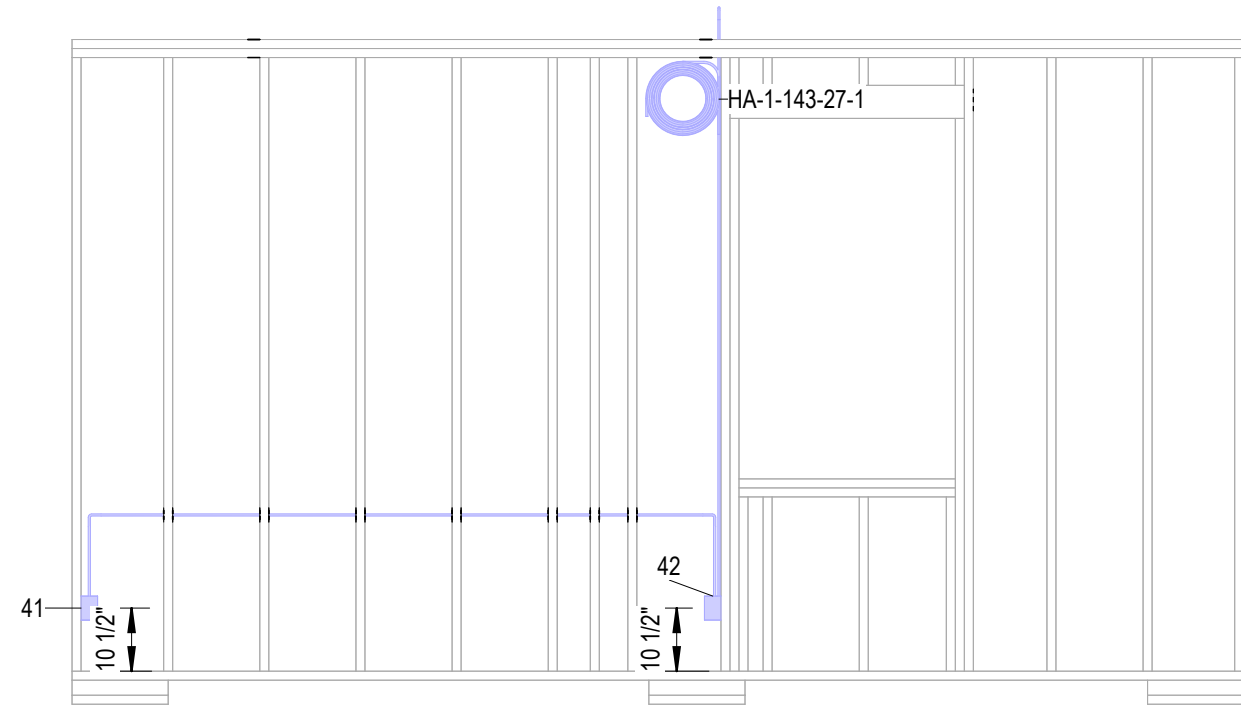

Electrical Fixture Schedule							
Mark	Side	Box	Device-A	Device-B	Device-C	Device-D	Comments
41	B	EZ18SNW	Receptacle: T5320W				
42	B	EZ18SNW	Receptacle: T5320W				

Protection Plate Schedule		
Count	Type	Side
7	NS1	B

Harness Assembly for TEE-143			
Prefix-Quadrant-Wall-Circuit-Whip-Index	Type	Total Length	Pull To
HA-1-143-27-1	14/2	50' - 3"	JB1-4

1 Electrical Side A
3/8" = 1'-0"

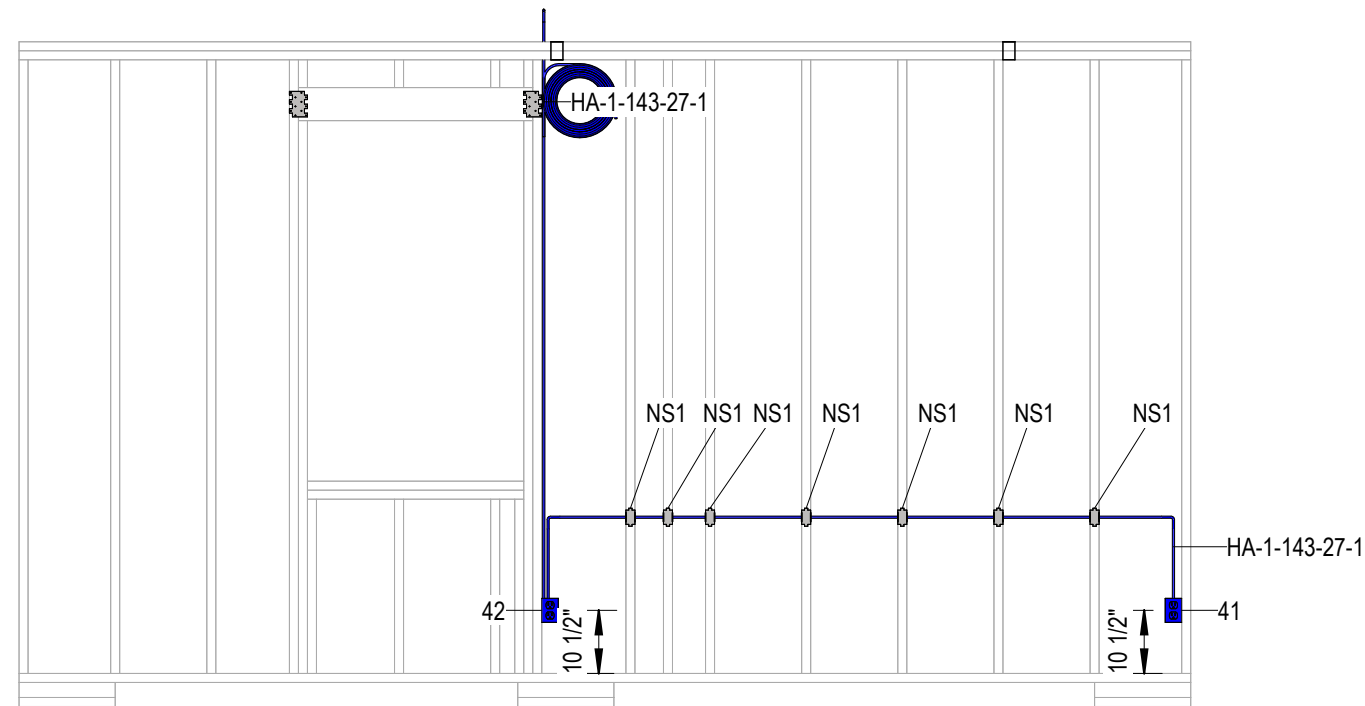

2 Electrical Side B
3/8" = 1'-0"

SUMMERSTONE
1550P
LOT 60
ELEV-B-LEFT

11/7/2025	For Review	NOT FOR CONSTRUCTION

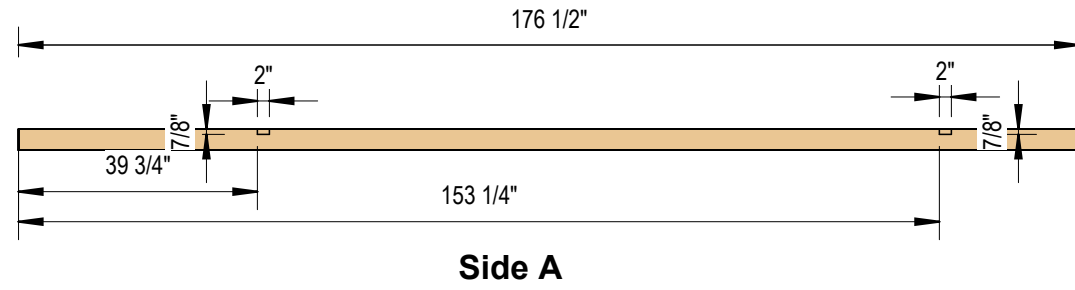

1 Top Plate
3/8" = 1'-0"

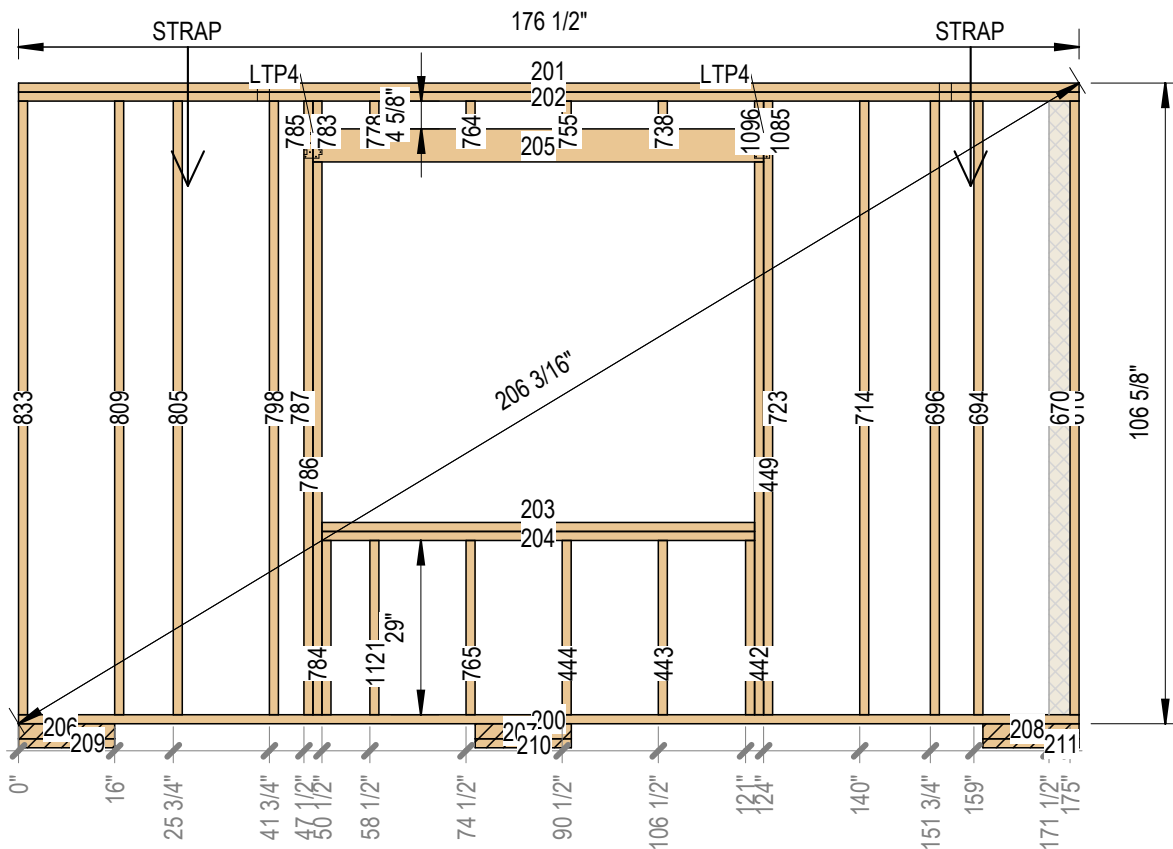

2 Framing Side A
3/8" = 1'-0"

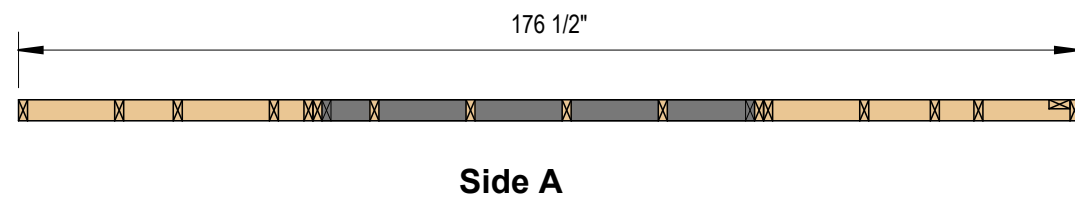

3 Bottom Plate
3/8" = 1'-0"

Structural Horizontal Framing Schedule

Mark	Piece Type	Description	Structural Material	Side	Cut Length
200	Bottom Plate	2x4	SPF #1/#2		176 1/2"
201	Top Plate	2x4	SPF #1/#2		176 1/2"
202	Top Plate	2x4	SPF #1/#2		176 1/2"
203	Sill	2x4	SPF #1/#2		72"
204	Sill	2x4	SPF #1/#2		72"
205	Header	4x6	DF #2		75"
206	Temporary	3x4	SPF Standard		16"
207	Temporary	3x4	SPF Standard		16"
208	Temporary	3x4	SPF Standard		16"
209	Temporary	2x4	SPF Standard		16"
210	Temporary	2x4	SPF Standard		16"
211	Temporary	2x4	SPF Standard		16"

Structural Stud Schedule

Mark	Piece Type	Description	Structural Material	Side	Length
442	SillCripple	2x4	SPF #1/#2		29"
443	SillCripple	2x4	SPF #1/#2		29"
444	SillCripple	2x4	SPF #1/#2		29"
449	Trimmer	2x4	SPF #1/#2		92"
610	Stud	2x4	SPF #1/#2		102 1/8"
670 - B	FlatStud	2x4	SPF #1/#2	B	102 1/8"
694	Stud	2x4	SPF #1/#2		102 1/8"
696	Stud	2x4	SPF #1/#2		102 1/8"
714	Stud	2x4	SPF #1/#2		102 1/8"
723	KingStud	2x4	SPF #1/#2		102 1/8"
738	HeaderCripple	2x4	SPF #1/#2		4 5/8"
755	HeaderCripple	2x4	SPF #1/#2		4 5/8"
764	HeaderCripple	2x4	SPF #1/#2		4 5/8"
765	SillCripple	2x4	SPF #1/#2		29"
778	HeaderCripple	2x4	SPF #1/#2		4 5/8"
783	HeaderCripple	2x4	SPF #1/#2		4 5/8"
784	SillCripple	2x4	SPF #1/#2		29"
786	Trimmer	2x4	SPF #1/#2		92"
787	KingStud	2x4	SPF #1/#2		102 1/8"
798	Stud	2x4	SPF #1/#2		102 1/8"
805	Stud	2x4	SPF #1/#2		102 1/8"
809	Stud	2x4	SPF #1/#2		102 1/8"
833	Stud	2x4	SPF #1/#2		102 1/8"
1096	HeaderCripple	2x4	SPF #1/#2		4 5/8"
1121	SillCripple	2x4	SPF #1/#2		29"

Structural Connection Schedule

Type	Count	Side
LTP4	2	B

SUMMERSTONE
1550P
LOT 60
ELEV-B-LEFT

11/7/2025 For Review
NOT FOR CONSTRUCTION

Structural Framing
144.1-TEE

Vertical Wall Sheathing Schedule				
Mark	Description	Thickness	Length	Height
68	Picasso	1"	75"	33 5/8"
106	Picasso	1"	31"	108"
107	Picasso	1"	22 1/2"	108"
108	Picasso	1"	28 1/2"	108"
109	Picasso	1"	24"	108"
110	Picasso	1"	75"	11 3/8"

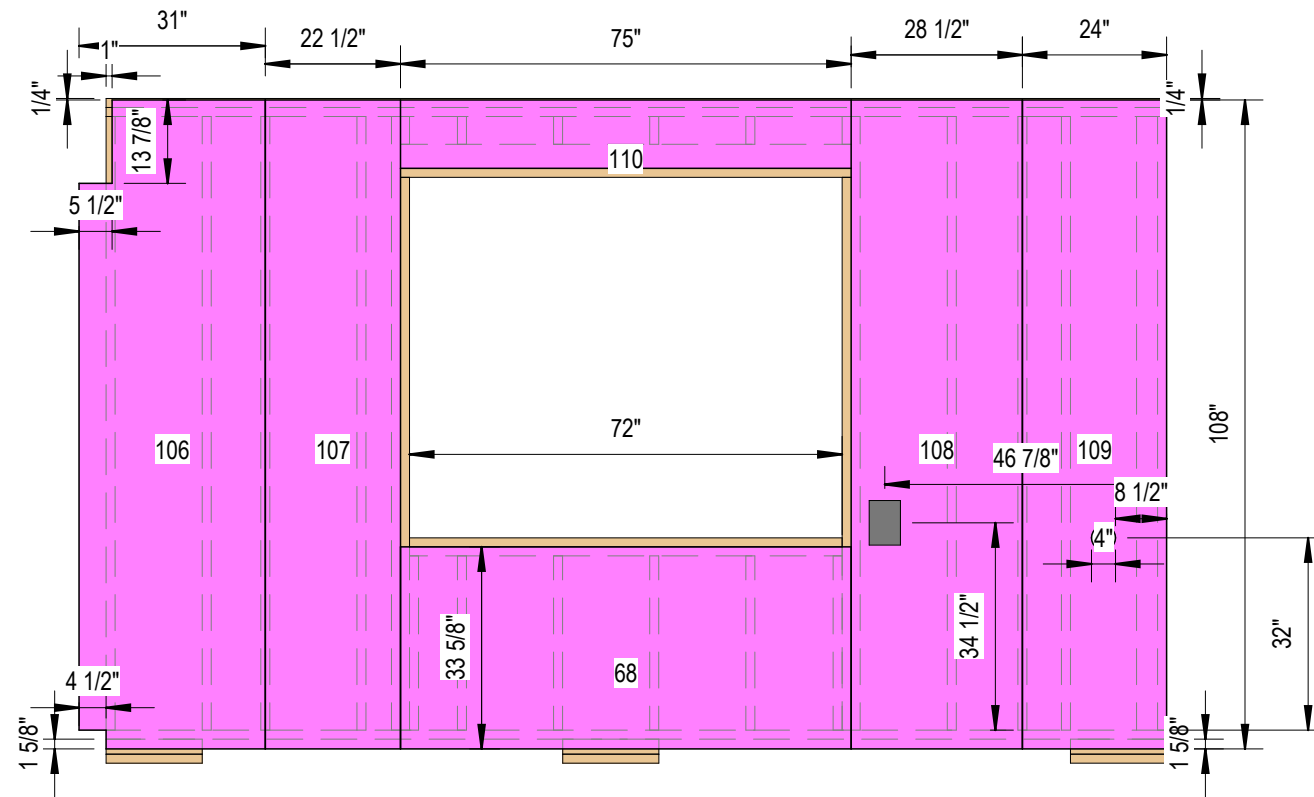

1 Sheathing Side A
3/8" = 1'-0"

SUMMERSTONE
1550P
LOT 60
ELEV-B-LEFT

11/7/2025	For Review				NOT FOR CONSTRUCTION

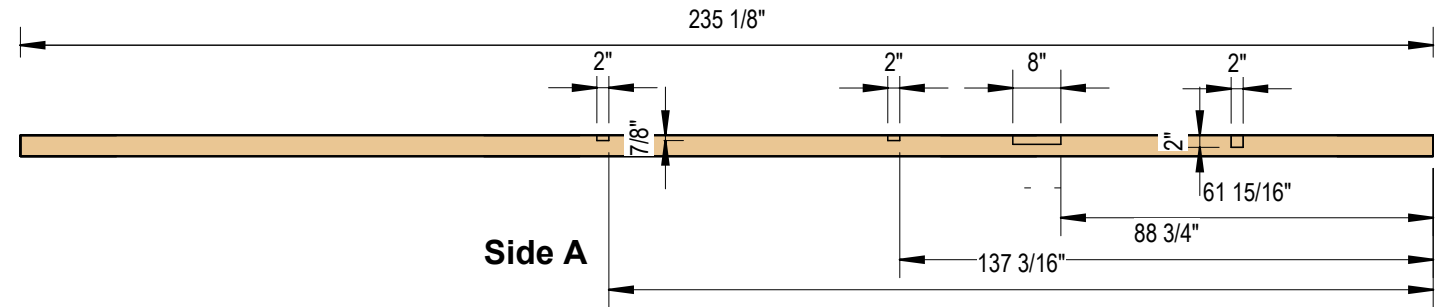

1 Top Plate
3/8" = 1'-0"

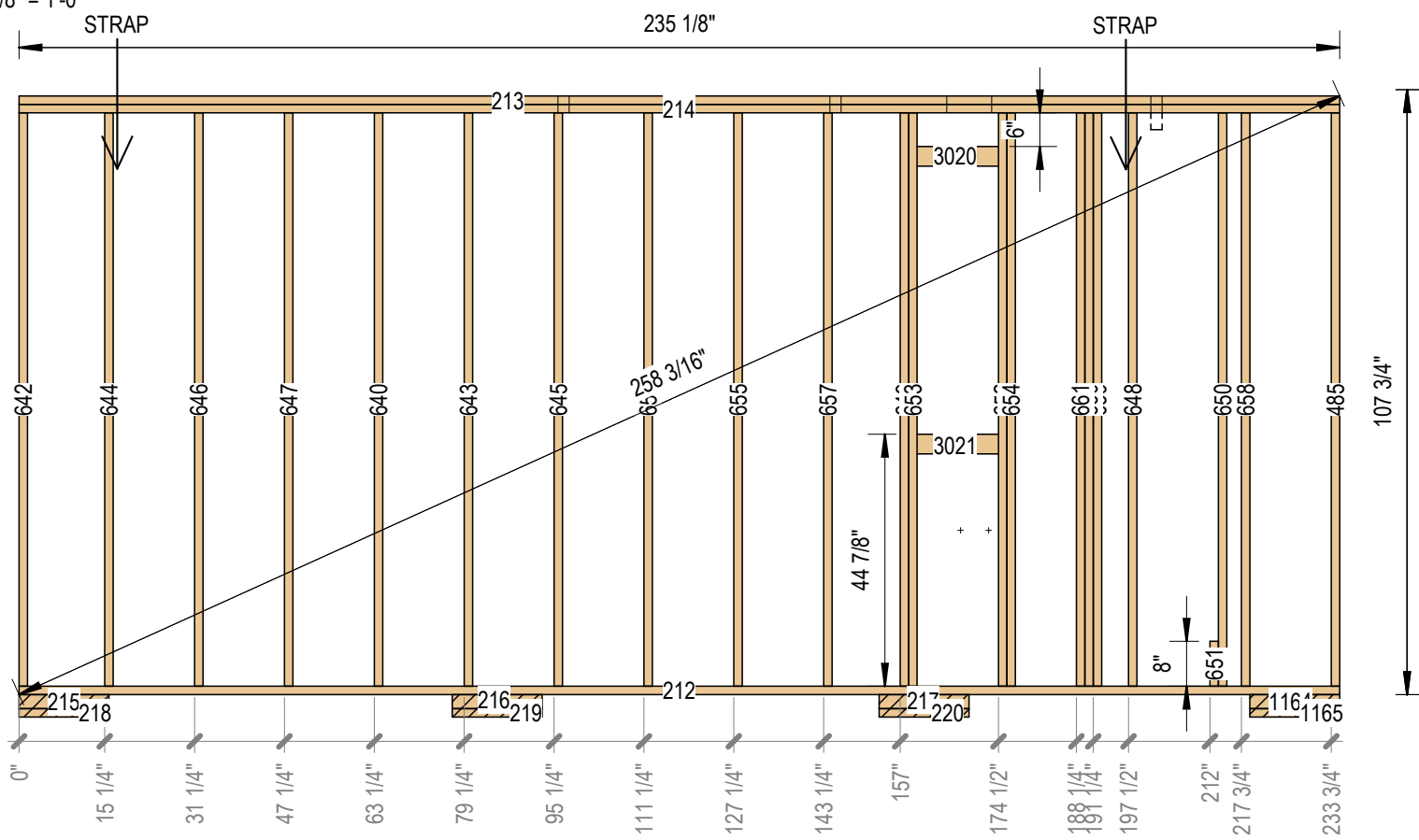

2 Framing Side A
3/8" = 1'-0"

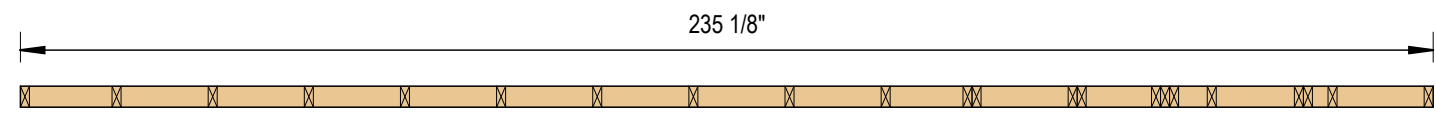

3 Bottom Plate
3/8" = 1'-0"

Structural Horizontal Framing Schedule

Mark	Piece Type	Description	Structural Material	Side	Cut Length
212	Bottom Plate	2x4	SPF #1/#2		235 1/8"
213	Top Plate	2x4	SPF #1/#2		235 1/8"
214	Top Plate	2x4	SPF #1/#2		235 1/8"
215	Temporary	3x4	SPF Standard		16"
216	Temporary	3x4	SPF Standard		16"
217	Temporary	3x4	SPF Standard		16"
218	Temporary	2x4	SPF Standard		16"
219	Temporary	2x4	SPF Standard		16"
220	Temporary	2x4	SPF Standard		16"
1164	Temporary	3x4	SPF Standard		16"
1165	Temporary	2x4	SPF Standard		16"
3020	Nog	2x4	SPF Standard		14 1/2"
3021	Nog	2x4	SPF Standard		14 1/2"

Structural Stud Schedule

Mark	Piece Type	Description	Structural Material	Side	Length
485	Stud	2x4	SPF #1/#2		102 1/8"
640	Stud	2x4	SPF #1/#2		102 1/8"
642	Stud	2x4	SPF #1/#2		102 1/8"
643	Stud	2x4	SPF #1/#2		102 1/8"
644	Stud	2x4	SPF #1/#2		102 1/8"
645	Stud	2x4	SPF #1/#2		102 1/8"
646	Stud	2x4	SPF #1/#2		102 1/8"
647	Stud	2x4	SPF #1/#2		102 1/8"
648	Stud	2x4	SPF #1/#2		102 1/8"
649	Stud	2x4	SPF #1/#2		102 1/8"
650	Stud	2x4	SPF #1/#2		102 1/8"
651	Stud	2x4	SPF #1/#2		8"
652	Stud	2x4	SPF #1/#2		102 1/8"
653	Stud	2x4	SPF #1/#2		102 1/8"
654	Stud	2x4	SPF #1/#2		102 1/8"
655	Stud	2x4	SPF #1/#2		102 1/8"
656	Stud	2x4	SPF #1/#2		102 1/8"
657	Stud	2x4	SPF #1/#2		102 1/8"
658	Stud	2x4	SPF #1/#2		102 1/8"
659	Stud	2x4	SPF #1/#2		102 1/8"
660	Stud	2x4	SPF #1/#2		102 1/8"
661	Stud	2x4	SPF #1/#2		102 1/8"

Structural Connection Schedule

Type	Count	Side

SUMMERSTONE
1550P
LOT 60
ELEV-B-LEFT

11/7/2025 For Review

NOT FOR CONSTRUCTION

Vertical Wall Sheathing Schedule				
Mark	Description	Thickness	Length	Height
111	Picasso	1"	48"	108"
112	Picasso	1"	48"	108"
113	Picasso	1"	48"	108"
114	Picasso	1"	48"	108"
115	Picasso	1"	48"	108"

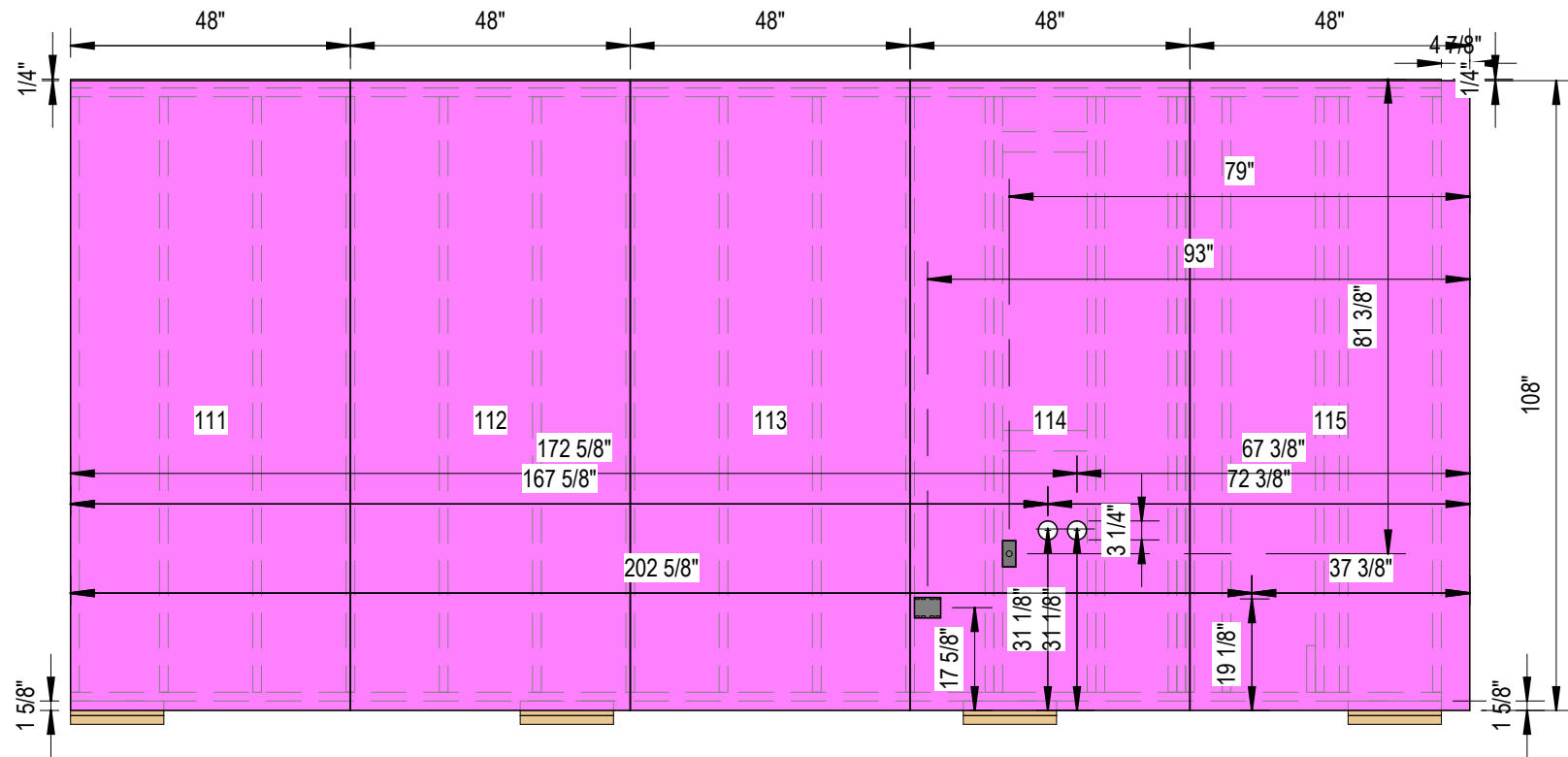

1 Sheathing Side A
3/8" = 1'-0"

SUMMERSTONE
1550P
LOT 60
ELEV-B-LEFT

11/7/2025 For Review						NOT FOR CONSTRUCTION
----------------------	--	--	--	--	--	-----------------------------

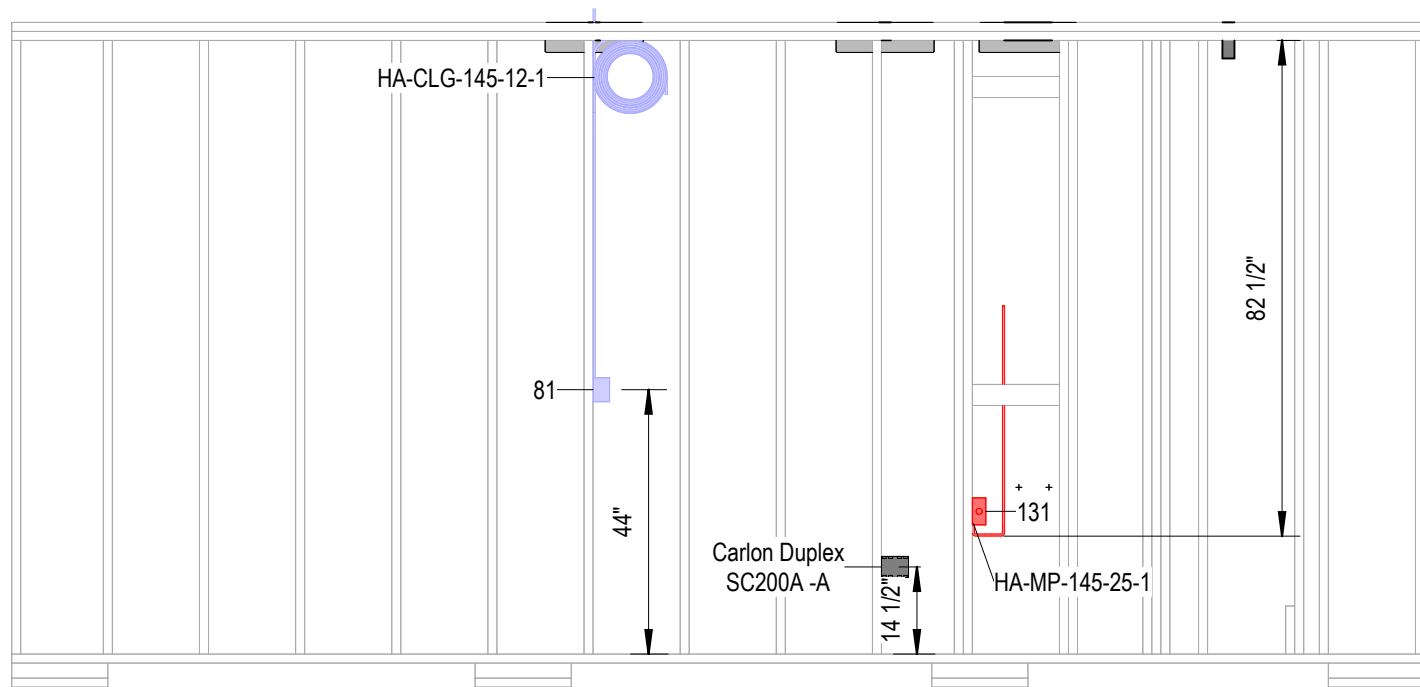

1 Electrical Side A
3/8" = 1'-0"

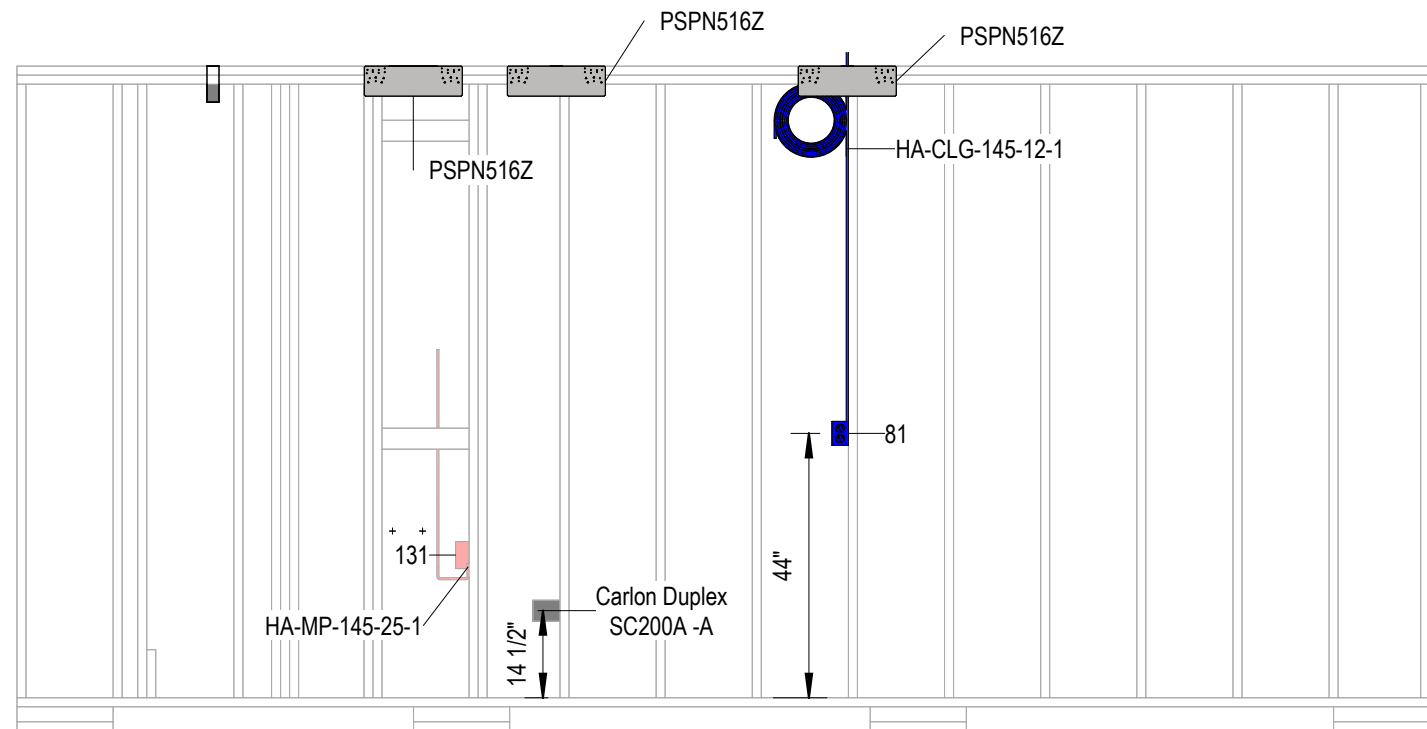

2 Electrical Side B
3/8" = 1'-0"

Electrical Fixture Schedule							
Mark	Side	Box	Device-A	Device-B	Device-C	Device-D	Comments
81	B	EZ18SNW	Receptacle: T5320W				Garage Typ
131	A	EZ18SNW	Photocontrol: Tork 3010				

Protection Plate Schedule		
Count	Type	Side
3	PSPN516Z	B

Harness Assembly for TEPE-145			
Prefix-Quadrant-Wall-Circuit-Whip-Index	Type	Total Length	Pull To
HA-CLG-145-12-1	12/2	22' - 0"	Ceiling Box 13
HA-MP-145-12-1	12/2	9' - 3"	
HA-MP-145-25-1	14/2	27' - 10"	<varies>

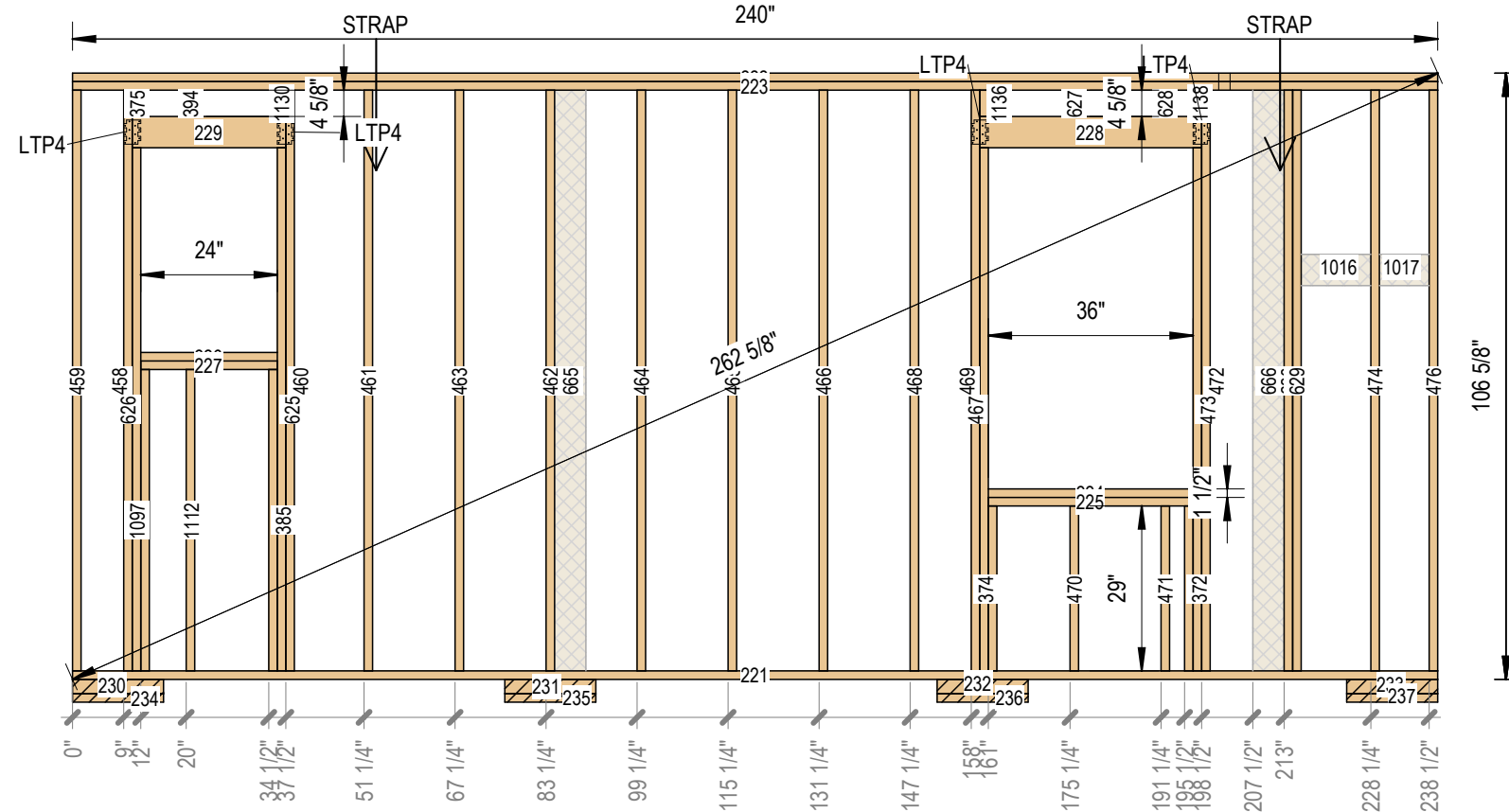
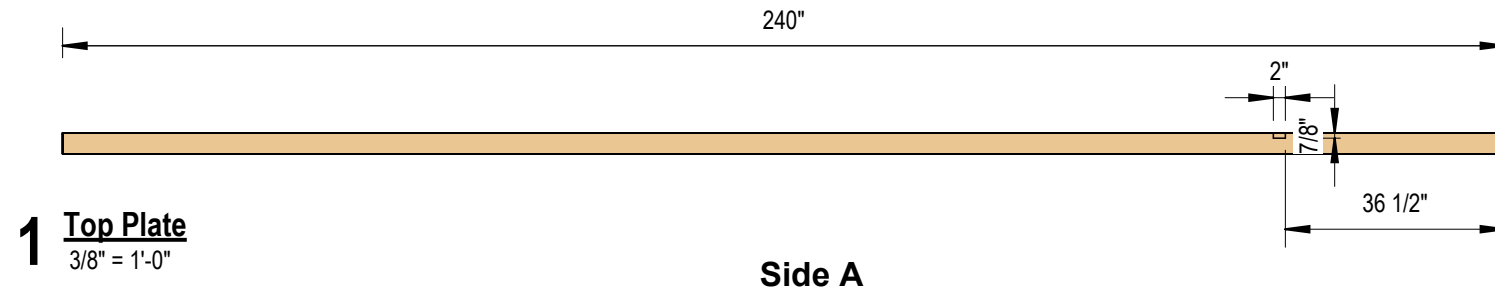

2 Framing Side A
3/8" = 1'-0"

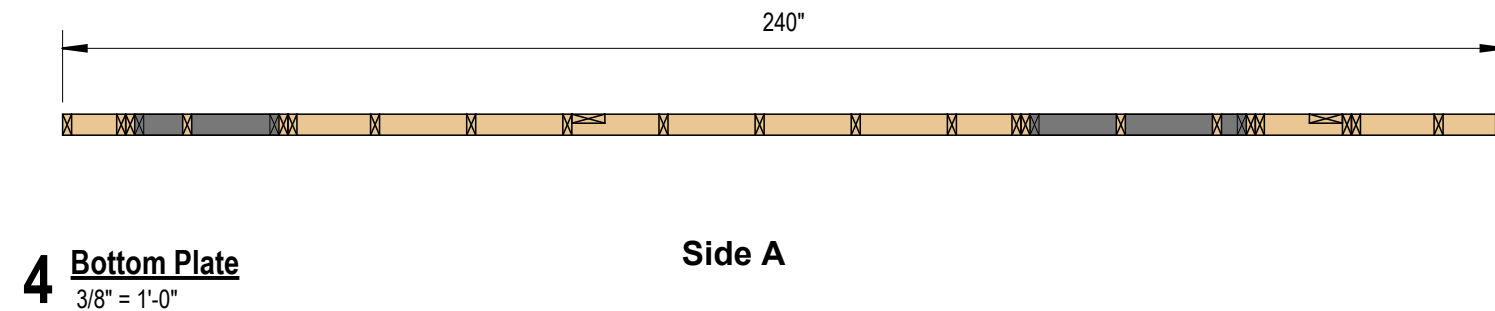

Structural Stud Schedule

Mark	Description	Count	Piece Type	Side	Length	Structural Material
372	2x4	1	SillCripple		29"	SPF #1/#2
374	2x4	1	SillCripple		29"	SPF #1/#2
375	2x4	1	HeaderCripple		4 5/8"	SPF #1/#2
385	2x4	1	SillCripple		53"	SPF #1/#2
394	2x4	1	HeaderCripple		4 5/8"	SPF #1/#2
458	2x4	1	KingStud		102 1/8"	SPF #1/#2
459	2x4	1	Stud		102 1/8"	SPF #1/#2
460	2x4	1	KingStud		102 1/8"	SPF #1/#2
461	2x4	1	Stud		102 1/8"	SPF #1/#2
462	2x4	1	Stud		102 1/8"	SPF #1/#2
463	2x4	1	Stud		102 1/8"	SPF #1/#2
464	2x4	1	Stud		102 1/8"	SPF #1/#2
465	2x4	1	Stud		102 1/8"	SPF #1/#2
466	2x4	1	Stud		102 1/8"	SPF #1/#2
467	2x4	1	Trimmer		92"	SPF #1/#2
468	2x4	1	Stud		102 1/8"	SPF #1/#2
469	2x4	1	KingStud		102 1/8"	SPF #1/#2
470	2x4	1	SillCripple		29"	SPF #1/#2
471	2x4	1	SillCripple		29"	SPF #1/#2
472	2x4	1	KingStud		102 1/8"	SPF #1/#2
473	2x4	1	Trimmer		92"	SPF #1/#2
474	2x4	1	Stud		102 1/8"	SPF #1/#2
476	2x4	1	Stud		102 1/8"	SPF #1/#2
625	2x4	1	KingStud		92"	SPF #1/#2
626	2x4	1	KingStud		92"	SPF #1/#2
627	2x4	1	HeaderCripple		4 5/8"	SPF #1/#2
628	2x4	1	HeaderCripple		4 5/8"	SPF #1/#2
629	2x4	1	Stud		102 1/8"	SPF #1/#2
630	2x4	1	Stud		102 1/8"	SPF #1/#2
665 - B	2x6	1	FlatStud	B	102 1/8"	SPF #1/#2
666 - B	2x6	1	FlatStud	B	102 1/8"	SPF #1/#2
1097	2x4	1	SillCripple		53"	SPF #1/#2
1112	2x4	1	SillCripple		53"	SPF #1/#2
1130	2x4	1	HeaderCripple		4 5/8"	SPF #1/#2
1136	2x4	1	HeaderCripple		4 5/8"	SPF #1/#2
1138	2x4	1	HeaderCripple		4 5/8"	SPF #1/#2

Structural Horizontal Framing Schedule

Mark	Description	Count	Piece Type	Side	Cut Length	Structural Material
221	2x4	1	Bottom Plate		240"	SPF #1/#2
222	2x4	1	Top Plate		240"	SPF #1/#2
223	2x4	1	Top Plate		240"	SPF #1/#2
224	2x4	1	Sill		36"	SPF #1/#2
225	2x4	1	Sill		36"	SPF #1/#2
226	2x4	1	Sill		24"	SPF #1/#2
227	2x4	1	Sill		24"	SPF #1/#2
228	4x6	1	Header		39"	DF #2
229	4x6	1	Header		27"	DF #2
230	3x4	1	Temporary		16"	SPF Standard
231	3x4	1	Temporary		16"	SPF Standard
232	3x4	1	Temporary		16"	SPF Standard
233	3x4	1	Temporary		16"	SPF Standard
234	2x4	1	Temporary		16"	SPF Standard
235	2x4	1	Temporary		16"	SPF Standard
236	2x4	1	Temporary		16"	SPF Standard
237	2x4	1	Temporary		16"	SPF Standard
1016	2x6	1	Flat Blocking	B	12 1/4"	SPF #1/#2
1017	2x6	1	Flat Blocking	B	8 3/4"	SPF #1/#2

Structural Connection Schedule

Type	Count	Side
LTP4	4	B



SUMMERSTONE
1550P
LOT 60
ELEV-B-LEFT

11/7/2025 For Review

NOT FOR CONSTRUCTION

Structural Framing
146.1-TEE

Vertical Wall Sheathing Schedule				
Mark	Description	Thickness	Length	Height
69	Picasso	1"	27"	57 5/8"
70	Picasso	1"	39"	33 5/8"
116	Picasso	1"	10 1/2"	108"
117	Picasso	1"	46 1/2"	108"
118	Picasso	1"	48"	108"
119	Picasso	1"	27 1/2"	108"
120	Picasso	1"	41 1/2"	108"
121	Picasso	1"	27"	11 3/8"
122	Picasso	1"	39"	11 3/8"

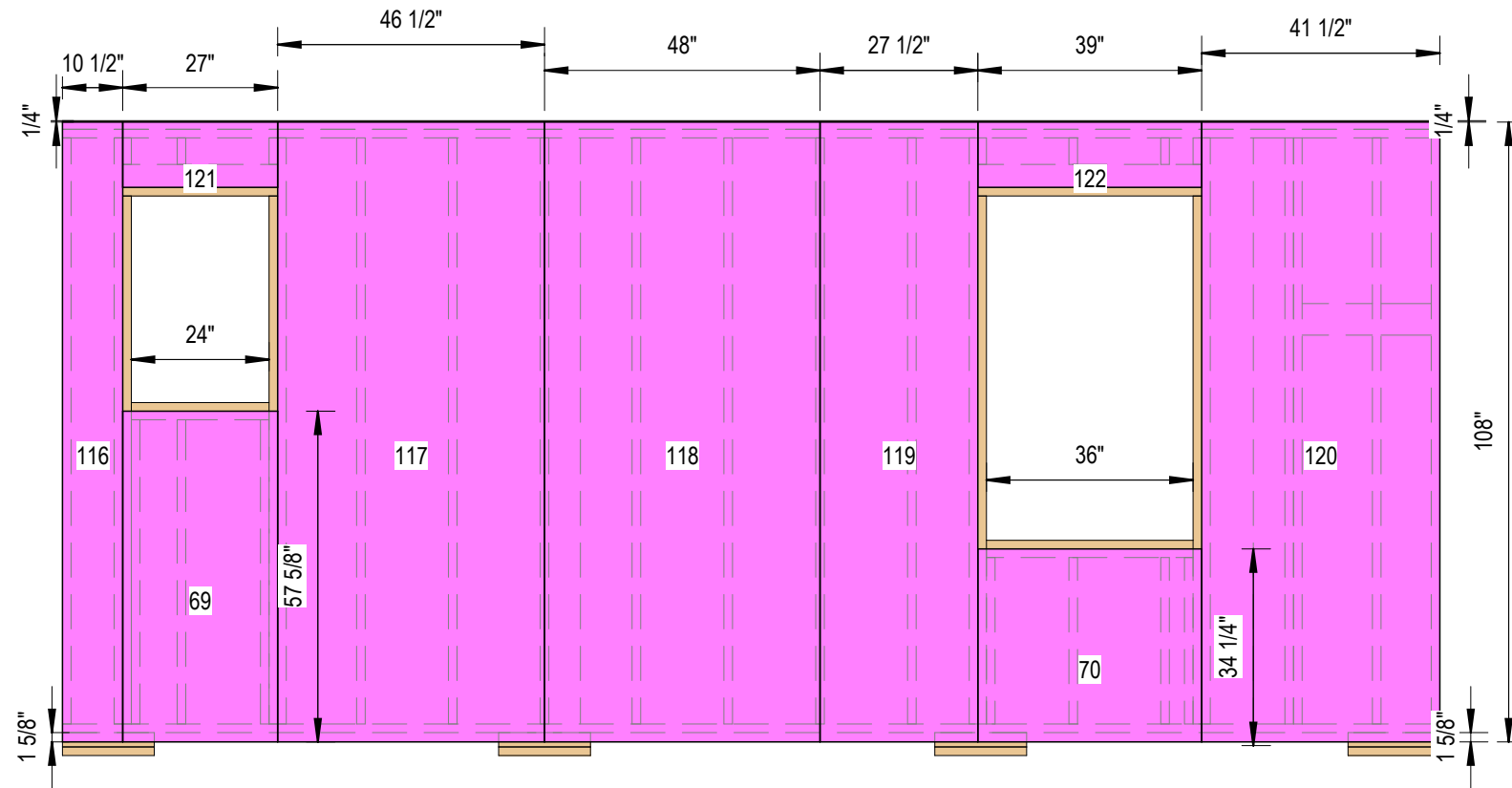

1 Sheathing Side A
3/8" = 1'-0"

SUMMERSTONE
1550P
 LOT 60
 ELEV-B-LEFT

11/7/2025	For Review					NOT FOR CONSTRUCTION

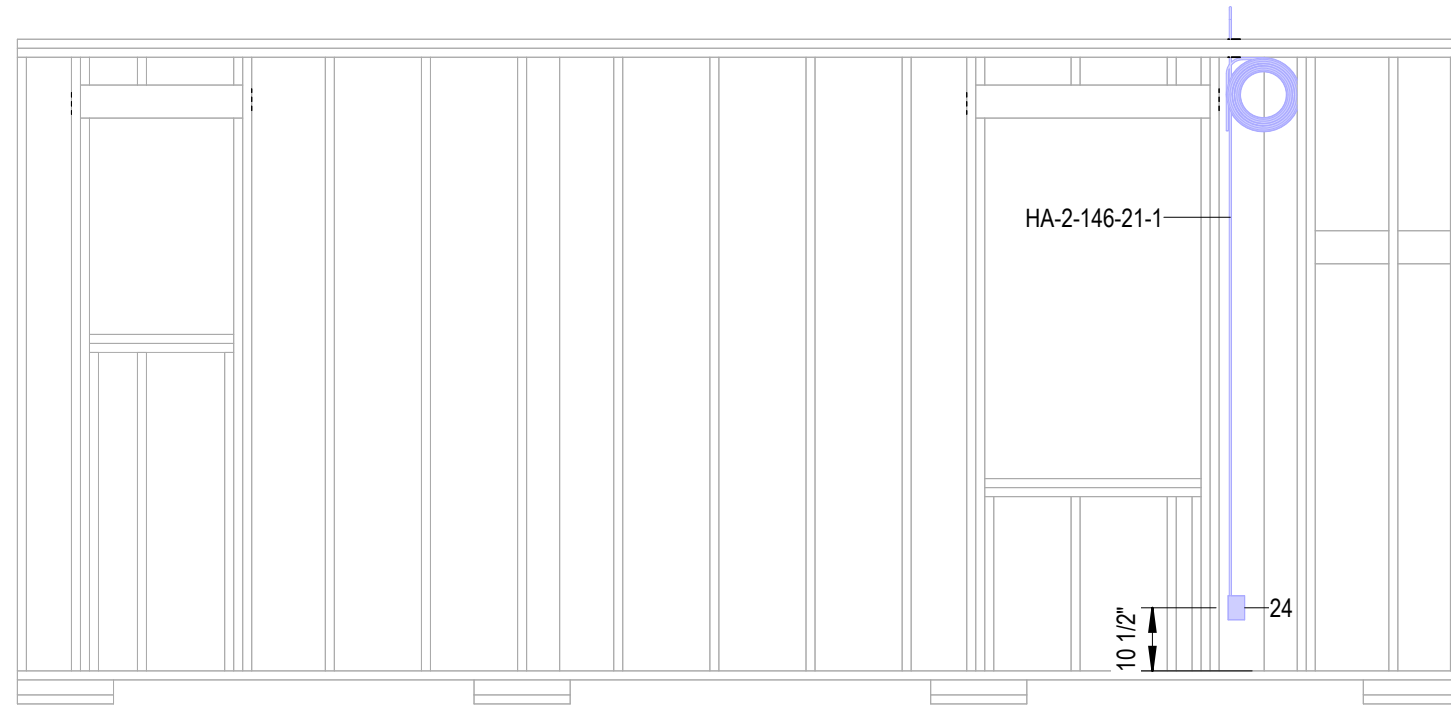

Electrical Fixture Schedule							
Mark	Side	Box	Device-A	Device-B	Device-C	Device-D	Comments
24	B	EZ18SNW	Receptacle: T5320W				

Protection Plate Schedule		
Count	Type	Side

Harness Assembly for TEE-146			
Prefix-Quadrant-Wall-Circuit-Whip-Index	Type	Total Length	Pull To
HA-2-146-21-1	14/2	28' - 0"	JB2-5

1 Electrical Side A
3/8" = 1'-0"

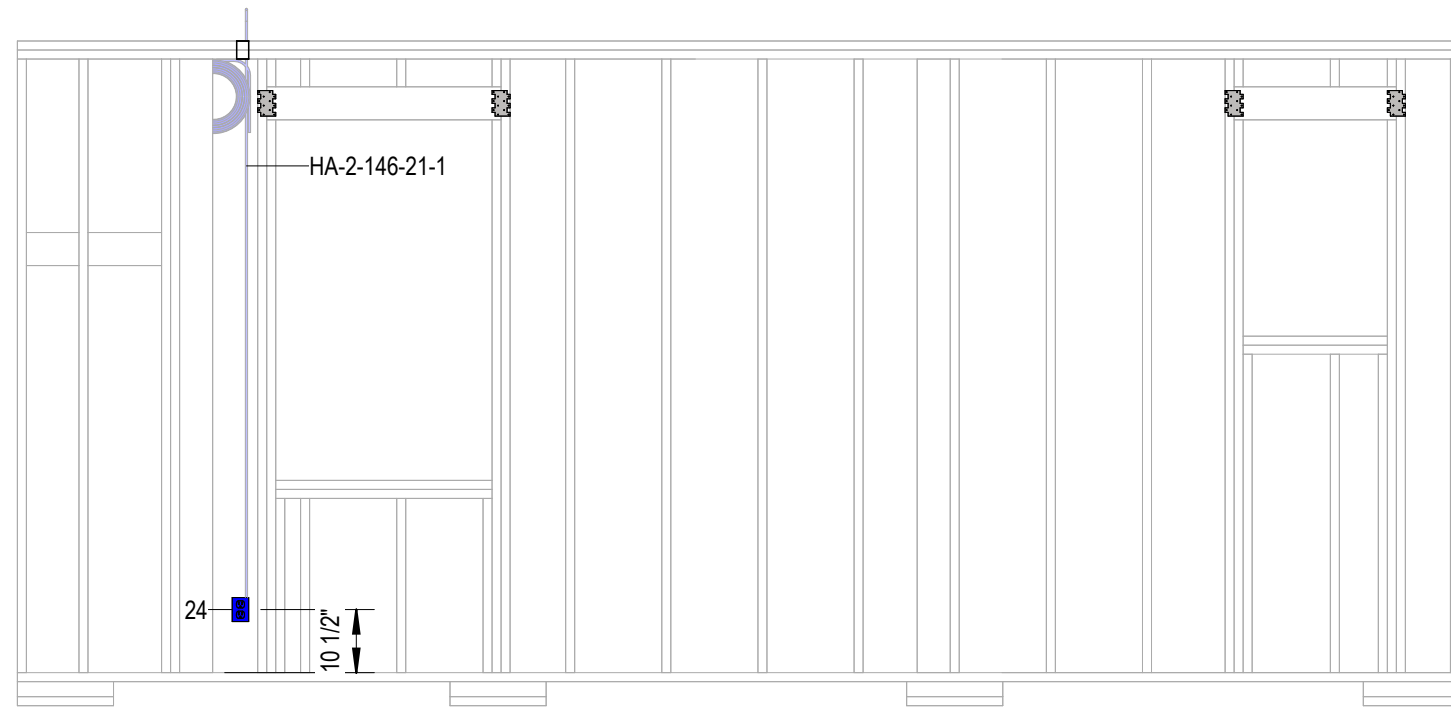

2 Electrical Side B
3/8" = 1'-0"

SUMMERSTONE
1550P
LOT 60
ELEV-B-LEFT

11/7/2025	For Review					NOT FOR CONSTRUCTION
-----------	------------	--	--	--	--	-----------------------------

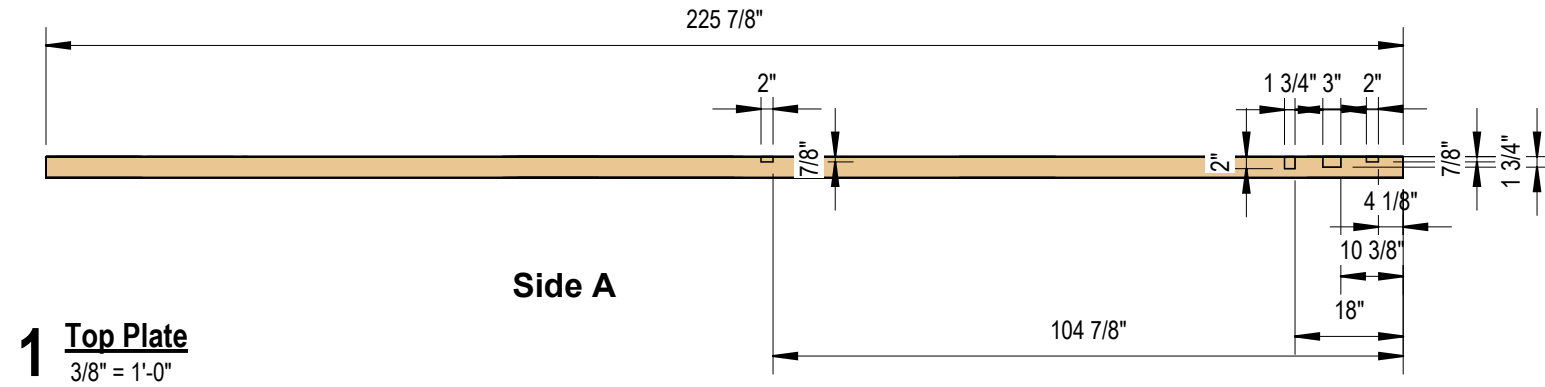

1 Top Plate
3/8" = 1'-0"

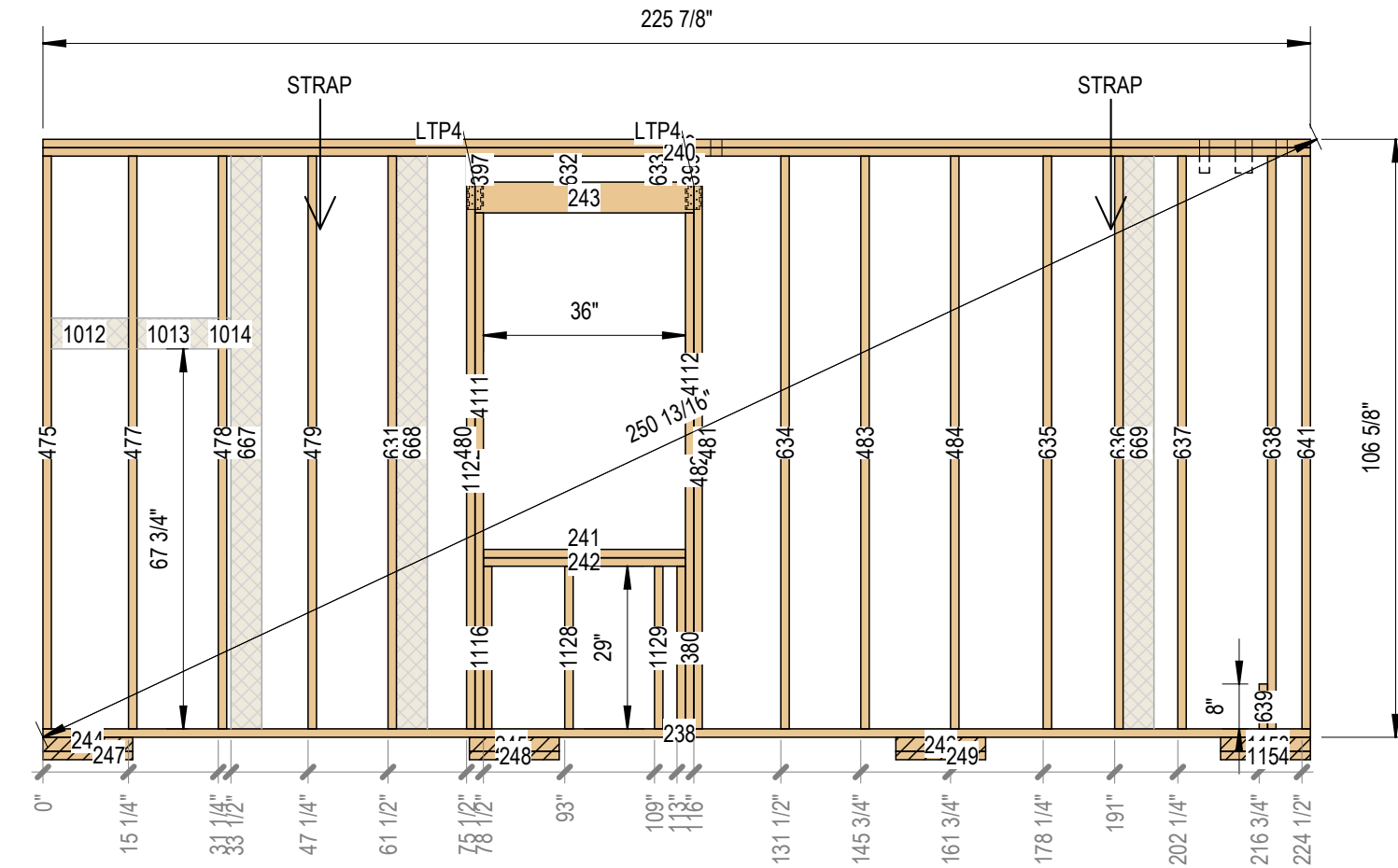

2 Framing Side A
3/8" = 1'-0"



4 Bottom Plate
3/8" = 1'-0"

Side A

Mark	Description	Count	Piece Type	Side	Cut Length	Structural Material
238	2x4	1	Bottom Plate		225 7/8"	SPF #1/#2
239	2x4	1	Top Plate		225 7/8"	SPF #1/#2
240	2x4	1	Top Plate		225 7/8"	SPF #1/#2
241	2x4	1	Sill		36"	SPF #1/#2
242	2x4	1	Sill		36"	SPF #1/#2
243	4x6	1	Header		39"	DF #2
244	3x4	1	Temporary		16"	SPF Standard
245	3x4	1	Temporary		16"	SPF Standard
246	3x4	1	Temporary		16"	SPF Standard
247	2x4	1	Temporary		16"	SPF Standard
248	2x4	1	Temporary		16"	SPF Standard
249	2x4	1	Temporary		16"	SPF Standard
1012	2x6	1	Flat Blocking	B	13 3/4"	SPF #1/#2
1013	2x6	1	Flat Blocking	B	14 1/2"	SPF #1/#2
1014	2x6	1	Flat Blocking	B	3/4"	SPF #1/#2
1153	3x4	1	Temporary		16"	SPF Standard
1154	2x4	1	Temporary		16"	SPF Standard

Mark	Description	Count	Piece Type	Side	Length	Structural Material
380	2x4	1	SillCripple		29"	SPF #1/#2
397	2x4	1	HeaderCripple		4 5/8"	SPF #1/#2
399	2x4	1	HeaderCripple		4 5/8"	SPF #1/#2
475	2x4	1	Stud		102 1/8"	SPF #1/#2
477	2x4	1	Stud		102 1/8"	SPF #1/#2
478	2x4	1	Stud		102 1/8"	SPF #1/#2
479	2x4	1	Stud		102 1/8"	SPF #1/#2
480	2x4	1	KingStud		102 1/8"	SPF #1/#2
481	2x4	1	KingStud		102 1/8"	SPF #1/#2
482	2x4	1	Trimmer		92"	SPF #1/#2
483	2x4	1	Stud		102 1/8"	SPF #1/#2
484	2x4	1	Stud		102 1/8"	SPF #1/#2
631	2x4	1	Stud		102 1/8"	SPF #1/#2
632	2x4	1	HeaderCripple		4 5/8"	SPF #1/#2
633	2x4	1	HeaderCripple		4 5/8"	SPF #1/#2
634	2x4	1	Stud		102 1/8"	SPF #1/#2
635	2x4	1	Stud		102 1/8"	SPF #1/#2
636	2x4	1	Stud		102 1/8"	SPF #1/#2
637	2x4	1	Stud		102 1/8"	SPF #1/#2
638	2x4	1	Stud		102 1/8"	SPF #1/#2
639	2x4	1	Stud		8"	SPF #1/#2
641	2x4	1	Stud		102 1/8"	SPF #1/#2
667 - B	2x6	1	FlatStud	B	102 1/8"	SPF #1/#2
668 - B	2x6	1	FlatStud	B	102 1/8"	SPF #1/#2
669 - B	2x6	1	FlatStud	B	102 1/8"	SPF #1/#2
1116	2x4	1	SillCripple		29"	SPF #1/#2
1122	2x4	1	Trimmer		92"	SPF #1/#2
1128	2x4	1	SillCripple		29"	SPF #1/#2
1129	2x4	1	SillCripple		29"	SPF #1/#2

Type	Count	Side
LTP4	2	B

SUMMERSTONE
1550P
LOT 60
ELEV-B-LEFT

11/7/2025 For Review

NOT FOR CONSTRUCTION

Structural Framing
147.1-TEPE

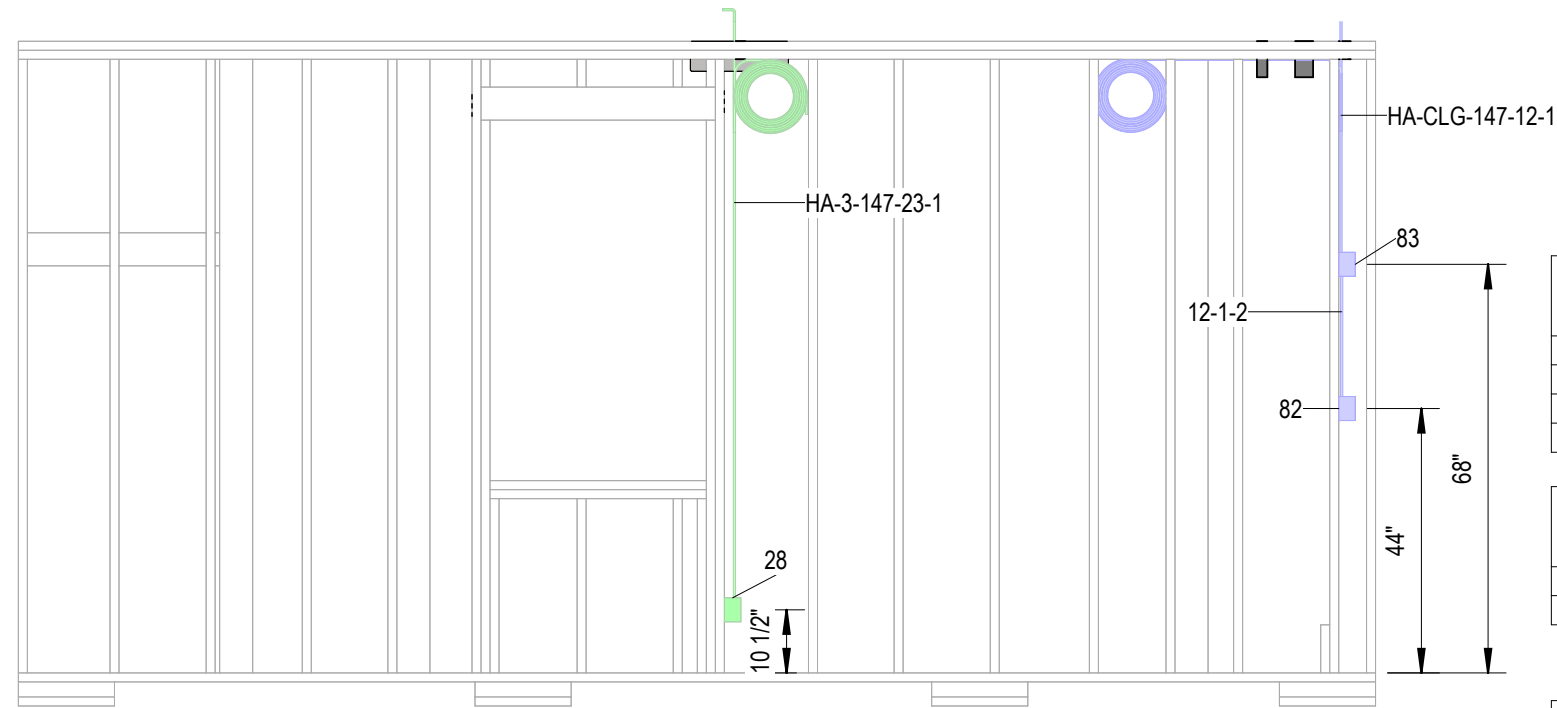

1 Electrical Elevation Side A
3/8" = 1'-0"

Electrical Fixture Schedule							
Mark	Side	Box	Device-A	Device-B	Device-C	Device-D	Comments
28	B	EZ18SNW	Receptacle: T5320W				
82	B	EZ18SNW	Receptacle: T5320W				WH Low
83	B	EZ18SNW	Receptacle: T5020WS				WH High

Protection Plate Schedule		
Count	Type	Side
1	PSPN516Z	B

Harness Assembly for TEPE-147			
Prefix-Quadrant-Wall-Circuit-Whip-Index	Type	Total Length	Pull To
HA-3-147-23-1	14/2	43' - 3"	JB3-7
HA-CLG-147-12-1	12/2	28' - 7"	Ceiling Box 13
HA-MP-147-10-1	14/2	9' - 0"	Panel 145, MP

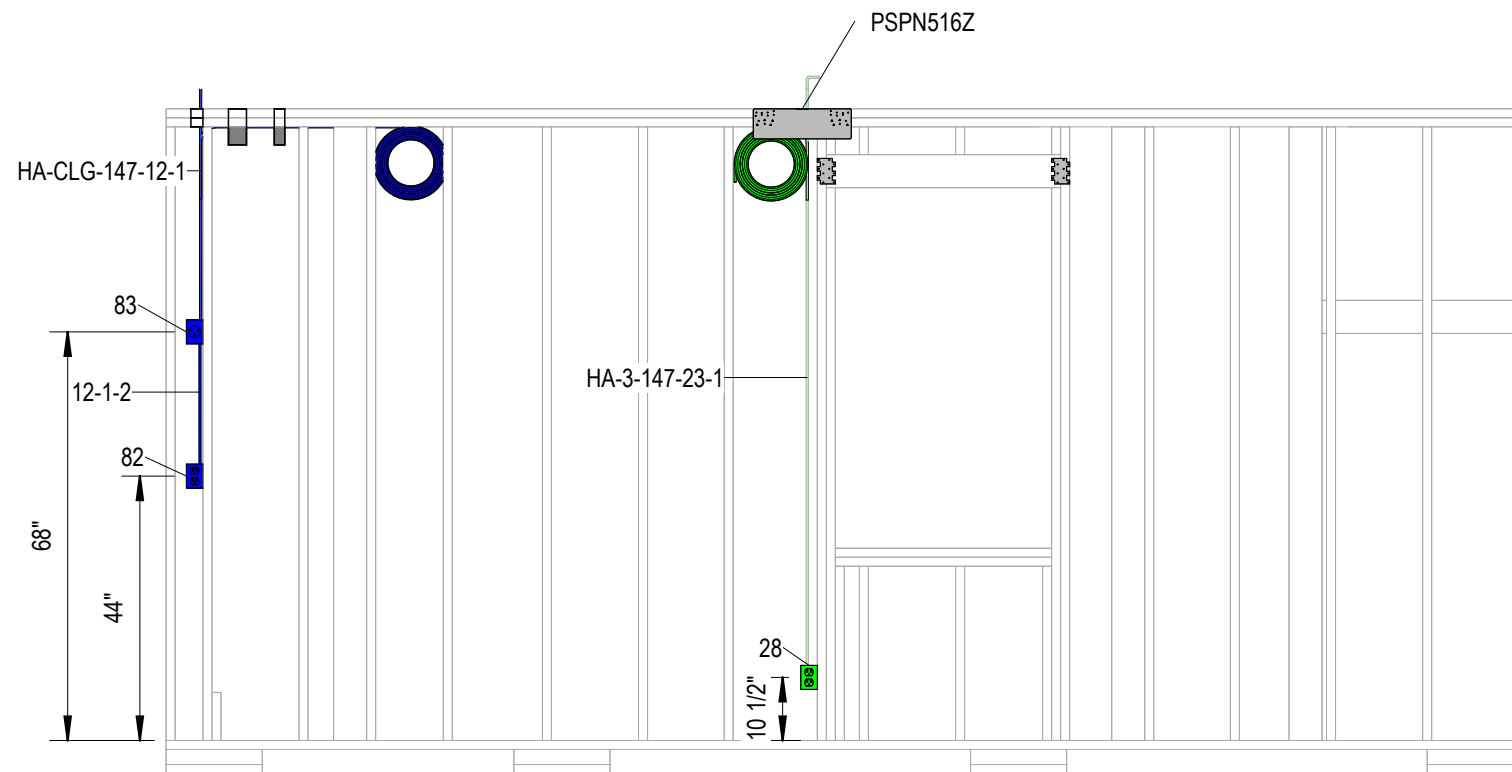

2 Electrical Elevation Side B
3/8" = 1'-0"

SUMMERSTONE
1550P
LOT 60
ELEV-B-LEFT

11/7/2025 For Review	NOT FOR CONSTRUCTION
----------------------	-----------------------------

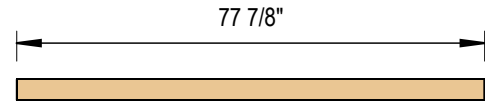

Side A

1 Top Plate
3/8" = 1'-0"

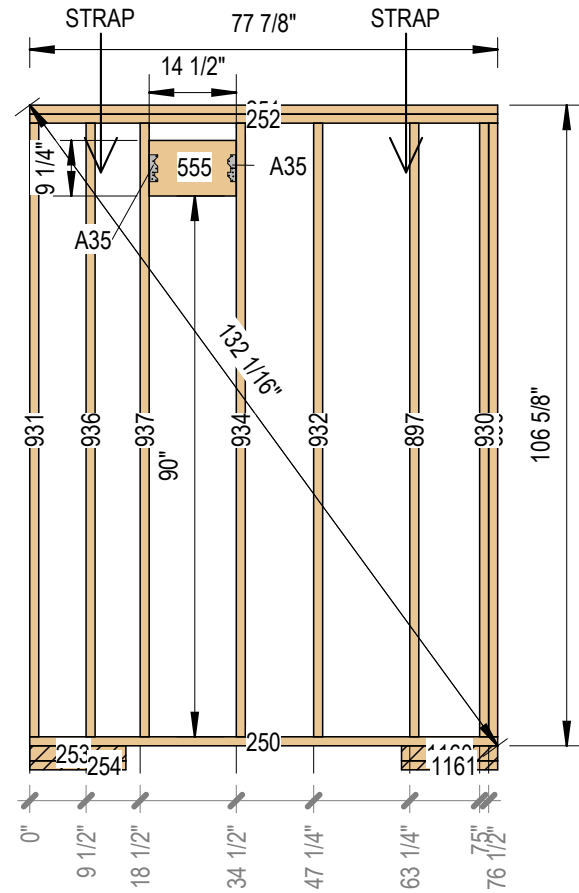

2 Framing Side A
3/8" = 1'-0"

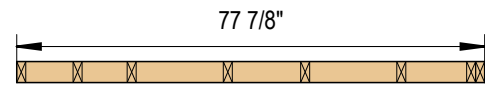

Side A

3 Bottom Plate
3/8" = 1'-0"

Structural Horizontal Framing Schedule

Mark	Description	Count	Piece Type	Side	Cut Length	Structural Material
250	2x4	1	Bottom Plate		77 7/8"	SPF #1/#2
251	2x4	1	Top Plate		77 7/8"	SPF #1/#2
252	2x4	1	Top Plate		77 7/8"	SPF #1/#2
253	3x4	1	Temporary		16"	SPF Standard
254	2x4	1	Temporary		16"	SPF Standard
555 - A	2x10	1	Flat Blocking	A	14 1/2"	SPF #1/#2
1160	3x4	1	Temporary		16"	SPF Standard
1161	2x4	1	Temporary		16"	SPF Standard

Structural Stud Schedule

Mark	Description	Count	Piece Type	Side	Length	Structural Material
896	2x4	1	Stud		102 1/8"	SPF #1/#2
897	2x4	1	Stud		102 1/8"	SPF #1/#2
930	2x4	1	Stud		102 1/8"	SPF #1/#2
931	2x4	1	Stud		102 1/8"	SPF #1/#2
932	2x4	1	Stud		102 1/8"	SPF #1/#2
934	2x4	1	Stud		102 1/8"	SPF #1/#2
936	2x4	1	Stud		102 1/8"	SPF #1/#2
937	2x4	1	Stud		102 1/8"	SPF #1/#2

Structural Connection Schedule

Type	Count	Side
A35	2	

11/7/2025	For Review	NOT FOR CONSTRUCTION

Vertical Wall Sheathing Schedule				
Mark	Description	Thickness	Length	Height
129	Picasso	1"	48"	108"
130	Picasso	1"	28 7/8"	108"

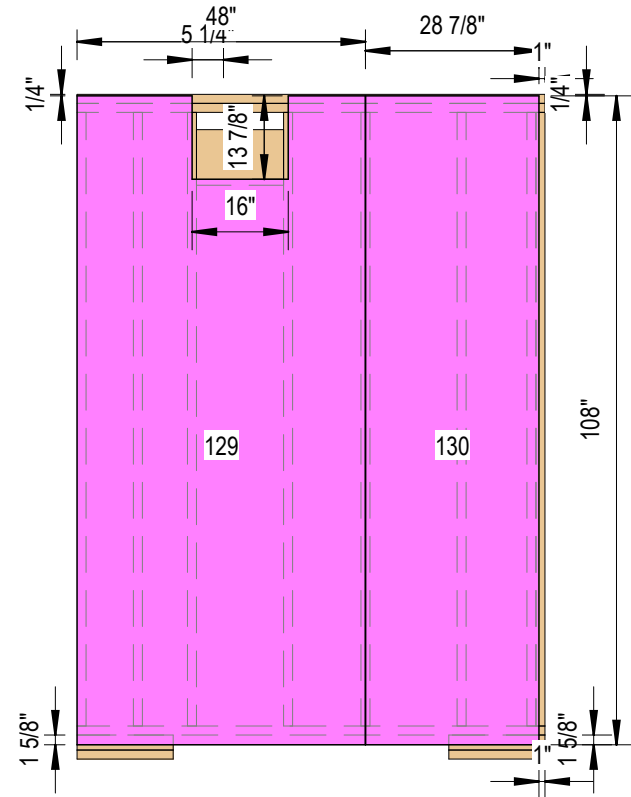

1 Sheathing Side A
3/8" = 1'-0"

SUMMERSTONE
1550P
LOT 60
ELEV-B-LEFT

11/7/2025	For Review					NOT FOR CONSTRUCTION

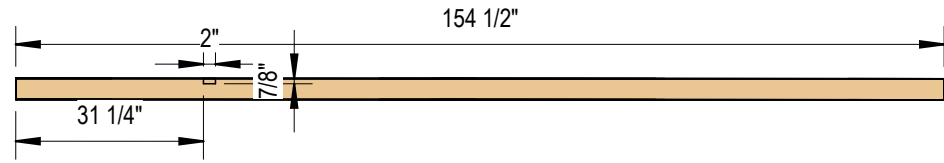

Side A

1 Top Plate
3/8" = 1'-0"

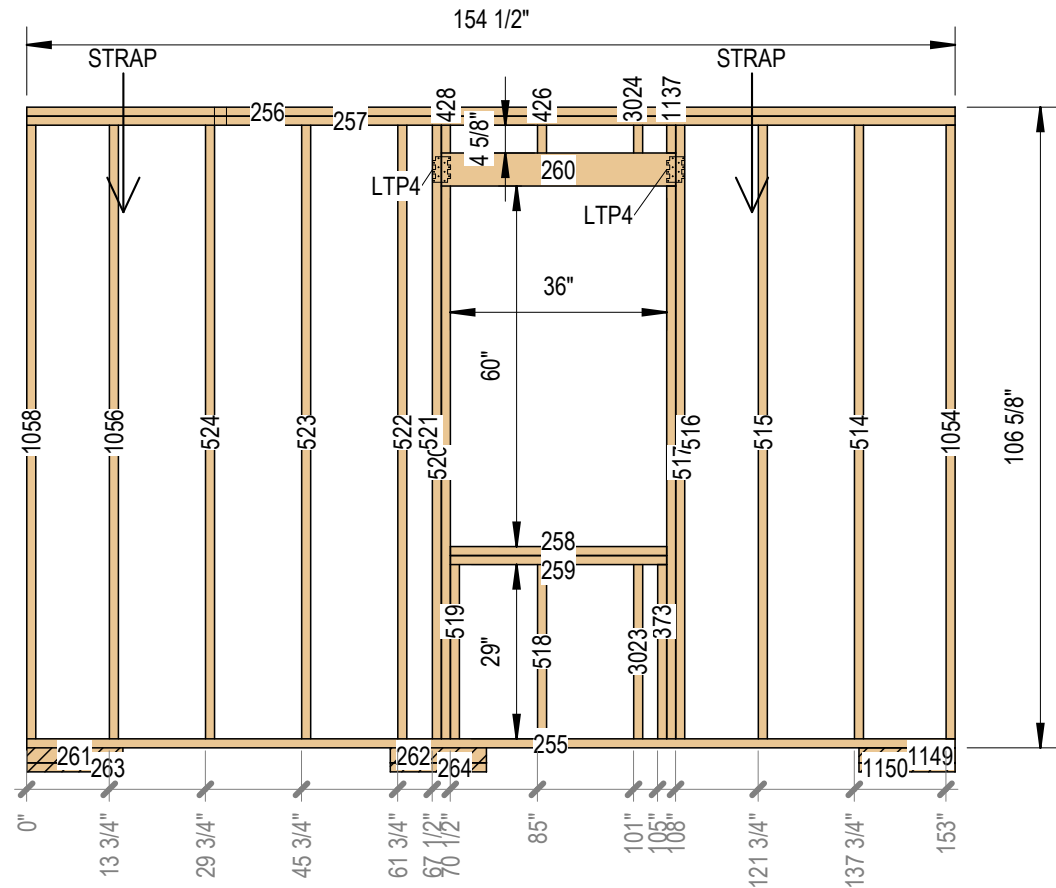

2 Framing Side A
3/8" = 1'-0"

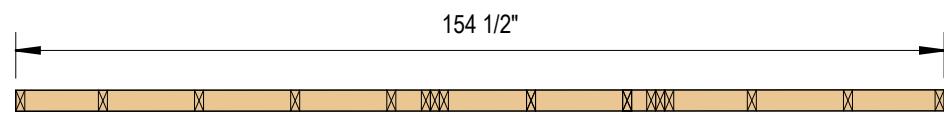

Side A

3 Bottom Plate
3/8" = 1'-0"

Structural Horizontal Framing Schedule

Mark	Description	Count	Piece Type	Side	Cut Length	Structural Material
255	2x4	1	Bottom Plate		154 1/2"	SPF #1/#2
256	2x4	1	Top Plate		154 1/2"	SPF #1/#2
257	2x4	1	Top Plate		154 1/2"	SPF #1/#2
258	2x4	1	Sill		36"	SPF #1/#2
259	2x4	1	Sill		36"	SPF #1/#2
260	4x6	1	Header		39"	DF #2
261	3x4	1	Temporary		16"	SPF Standard
262	3x4	1	Temporary		16"	SPF Standard
263	2x4	1	Temporary		16"	SPF Standard
264	2x4	1	Temporary		16"	SPF Standard
1149	3x4	1	Temporary		16"	SPF Standard
1150	2x4	1	Temporary		16"	SPF Standard

Structural Stud Schedule

Mark	Description	Count	Piece Type	Side	Length	Structural Material
373	2x4	1	SillCripple		29"	SPF #1/#2
426	2x4	1	HeaderCripple		4 5/8"	SPF #1/#2
428	2x4	1	HeaderCripple		4 5/8"	SPF #1/#2
514	2x4	1	Stud		102 1/8"	SPF #1/#2
515	2x4	1	Stud		102 1/8"	SPF #1/#2
516	2x4	1	KingStud		102 1/8"	SPF #1/#2
517	2x4	1	Trimmer		92"	SPF #1/#2
518	2x4	1	SillCripple		29"	SPF #1/#2
519	2x4	1	SillCripple		29"	SPF #1/#2
520	2x4	1	Trimmer		92"	SPF #1/#2
521	2x4	1	KingStud		102 1/8"	SPF #1/#2
522	2x4	1	Stud		102 1/8"	SPF #1/#2
523	2x4	1	Stud		102 1/8"	SPF #1/#2
524	2x4	1	Stud		102 1/8"	SPF #1/#2
1054	2x4	1	Stud		102 1/8"	SPF #1/#2
1056	2x4	1	Stud		102 1/8"	SPF #1/#2
1058	2x4	1	Stud		102 1/8"	SPF #1/#2
1137	2x4	1	HeaderCripple		4 5/8"	SPF #1/#2
3023	2x4	1	SillCripple		29"	SPF #1/#2
3024	2x4	1	HeaderCripple		4 5/8"	SPF #1/#2

Structural Connection Schedule

Type	Count	Side
LTP4	2	B

SUMMERSTONE
1550P
LOT 60
ELEV-B-LEFT

11/7/2025 For Review

NOT FOR CONSTRUCTION

Structural Framing
149.1-TEE

Vertical Wall Sheathing Schedule				
Mark	Description	Thickness	Length	Height
72	Picasso	1"	39"	33 5/8"
131	Picasso	1"	46 1/2"	108"
132	Picasso	1"	22 1/2"	108"
133	Picasso	1"	46 1/2"	108"
134	Picasso	1"	39"	11 3/8"

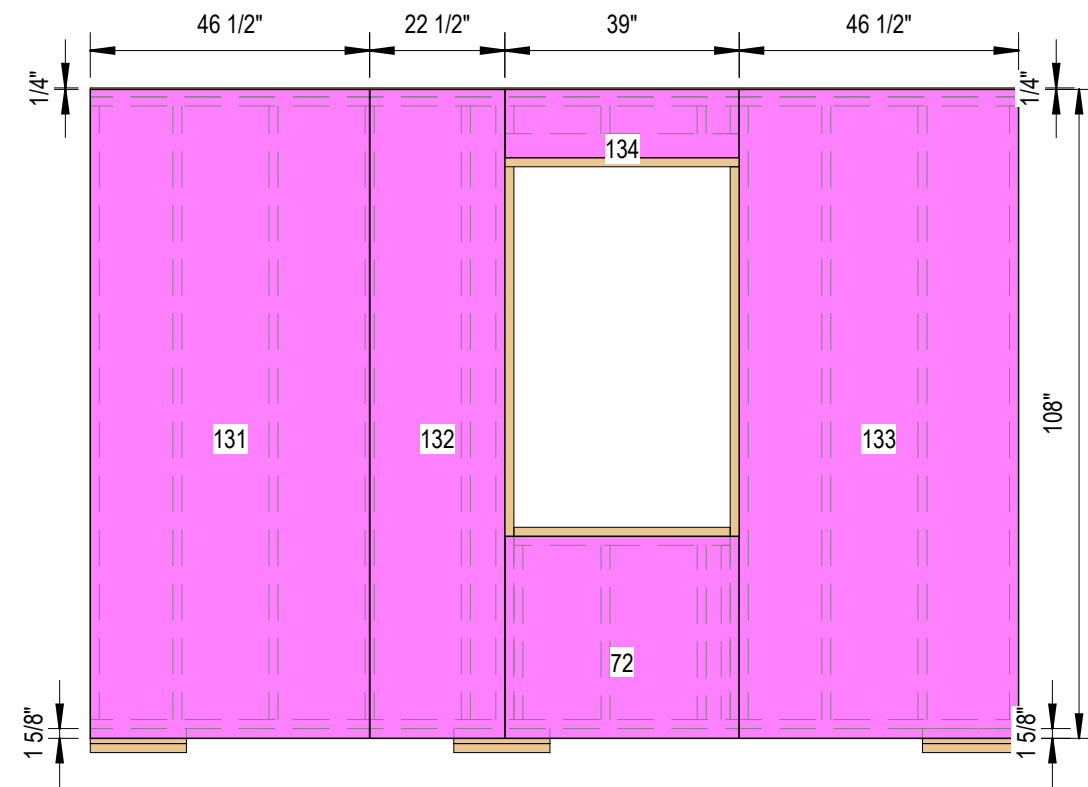

1 Sheathing Side A
3/8" = 1'-0"

SUMMERSTONE
1550P
LOT 60
ELEV-B-LEFT

11/7/2025	For Review				NOT FOR CONSTRUCTION

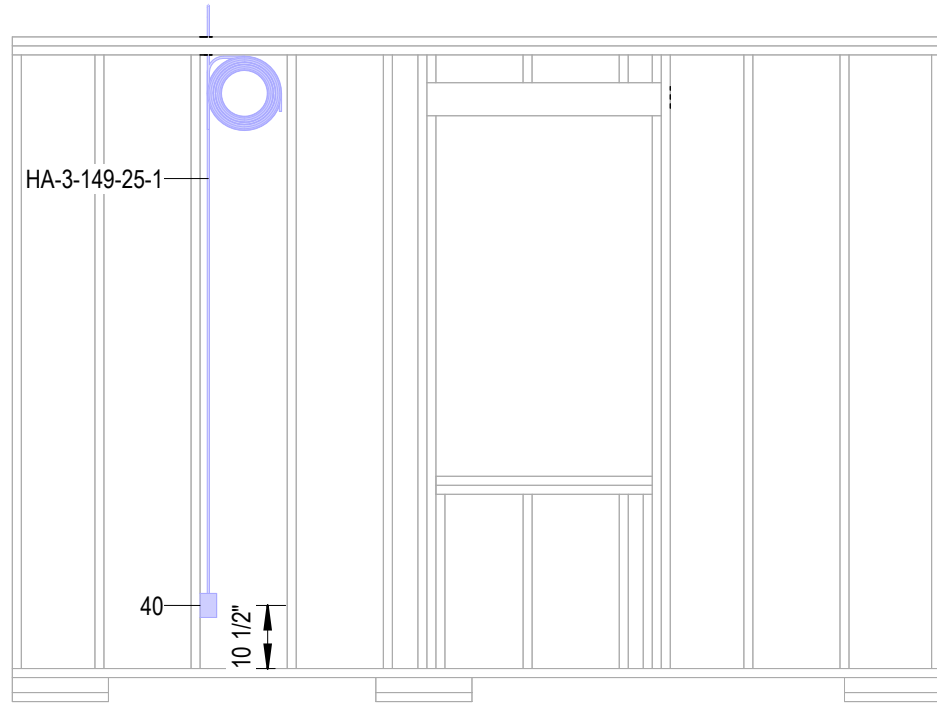

1 Electrical Side A
3/8" = 1'-0"

Electrical Fixture Schedule							
Mark	Side	Box	Device-A	Device-B	Device-C	Device-D	Comments
40	B	EZ18SNW	Receptacle: T5320W				

Protection Plate Schedule		
Count	Type	Side

Harness Assembly for TEE-149			
Prefix-Quadrant-Wall-Circuit-Whip-Index	Type	Total Length	Pull To
HA-3-149-25-1	14/2	40' - 9"	JB3-3

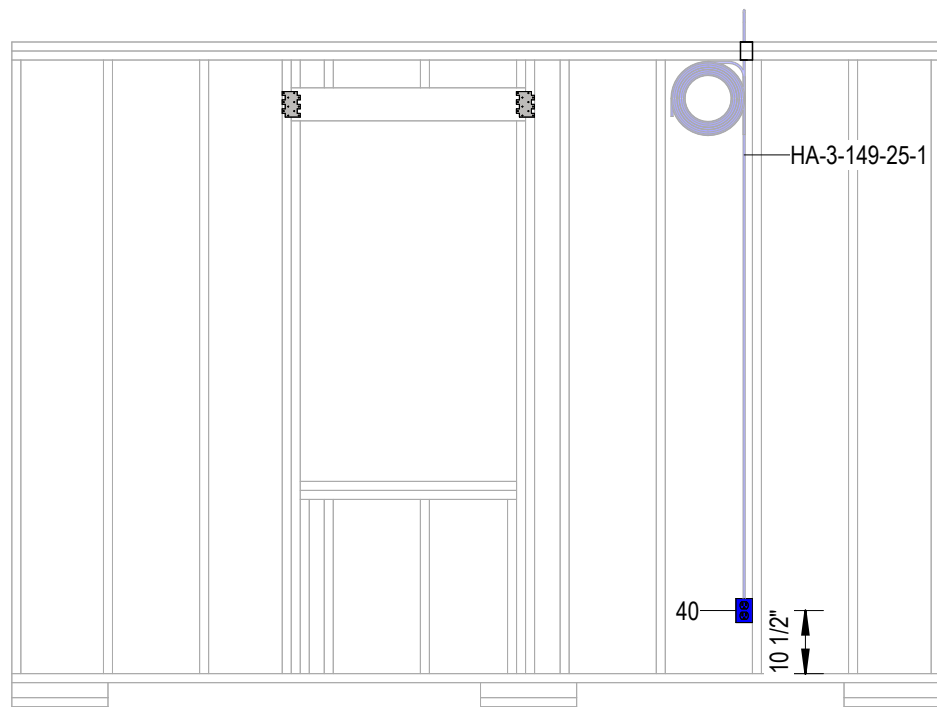

2 Electrical Side B
3/8" = 1'-0"

SUMMERSTONE
1550P
LOT 60
ELEV-B-LEFT

11/7/2025	For Review						NOT FOR CONSTRUCTION
-----------	------------	--	--	--	--	--	-----------------------------

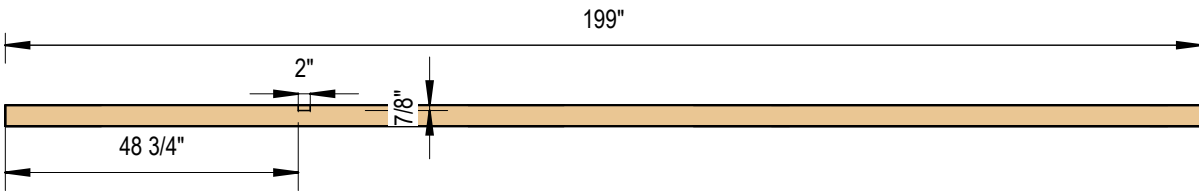

1 Top Plate
3/8" = 1'-0"

Side A

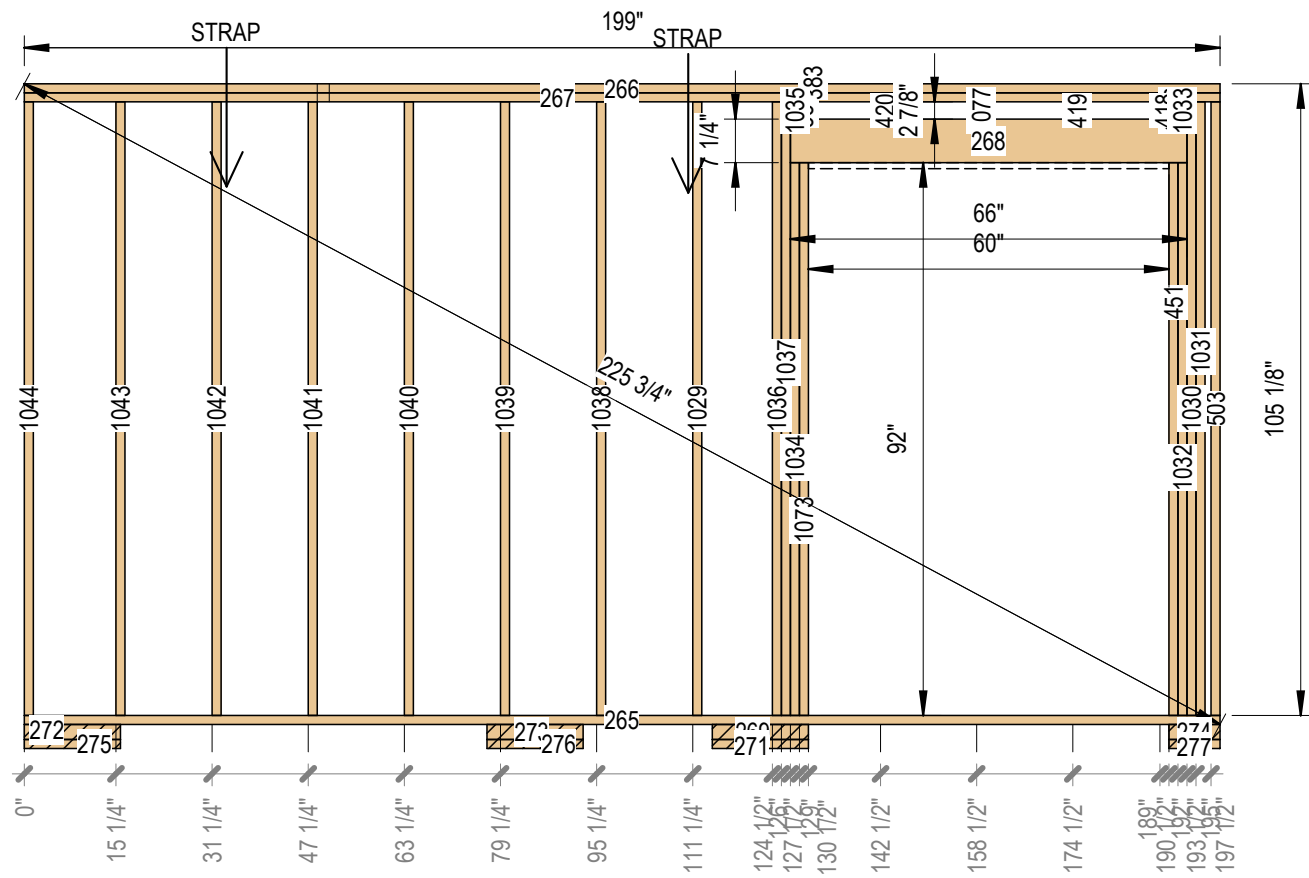

2 Framing Side A
3/8" = 1'-0"

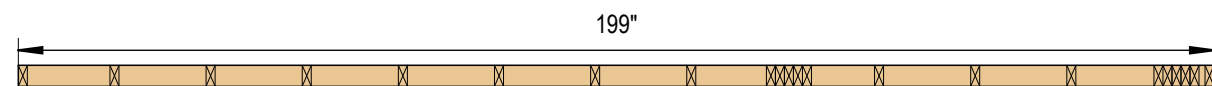

3 Bottom Plate
3/8" = 1'-0"

Side A

Structural Horizontal Framing Schedule

Mark	Description	Count	Piece Type	Side	Cut Length	Structural Material
265	2x4	1	Bottom Plate		199"	SPF #1/#2
266	2x4	1	Top Plate		199"	SPF #1/#2
267	2x4	1	Top Plate		199"	SPF #1/#2
268	4x8	1	Header		66"	DF #2
269	3x4	1	Temporary		16"	SPF Standard
271	2x4	1	Temporary		16"	SPF Standard
272	3x4	1	Temporary		16"	SPF Standard
273	3x4	1	Temporary		16"	SPF Standard
274	3x4	1	Temporary		8 1/2"	SPF Standard
275	2x4	1	Temporary		16"	SPF Standard
276	2x4	1	Temporary		16"	SPF Standard
277	2x4	1	Temporary		8 1/2"	SPF Standard

Structural Stud Schedule

Mark	Description	Count	Piece Type	Side	Length	Structural Material
383	2x4	1	HeaderCripple		2 7/8"	SPF #1/#2
384	2x4	1	HeaderCripple		2 7/8"	SPF #1/#2
418	2x4	1	HeaderCripple		2 7/8"	SPF #1/#2
419	2x4	1	HeaderCripple		2 7/8"	SPF #1/#2
420	2x4	1	HeaderCripple		2 7/8"	SPF #1/#2
451	2x4	1	Trimmer		92"	SPF #1/#2
503	2x4	1	Stud		102 1/8"	SPF #1/#2
1029	2x4	1	Stud		102 1/8"	SPF #1/#2
1030	2x4	1	KingStud		102 1/8"	SPF #1/#2
1031	2x4	1	KingStud		102 1/8"	SPF #1/#2
1032	2x4	1	Trimmer		92"	SPF #1/#2
1033	2x4	1	HeaderCripple		2 7/8"	SPF #1/#2
1034	2x4	1	Trimmer		92"	SPF #1/#2
1035	2x4	1	HeaderCripple		2 7/8"	SPF #1/#2
1036	2x4	1	Stud		102 1/8"	SPF #1/#2
1037	2x4	1	Stud		102 1/8"	SPF #1/#2
1038	2x4	1	Stud		102 1/8"	SPF #1/#2
1039	2x4	1	Stud		102 1/8"	SPF #1/#2
1040	2x4	1	Stud		102 1/8"	SPF #1/#2
1041	2x4	1	Stud		102 1/8"	SPF #1/#2
1042	2x4	1	Stud		102 1/8"	SPF #1/#2
1043	2x4	1	Stud		102 1/8"	SPF #1/#2
1044	2x4	1	Stud		102 1/8"	SPF #1/#2
1073	2x4	1	Trimmer		92"	SPF #1/#2
1076	2x4	1	HeaderCripple		2 7/8"	SPF #1/#2
1077	2x4	1	HeaderCripple		2 7/8"	SPF #1/#2

Structural Connection Schedule

Type	Count	Side

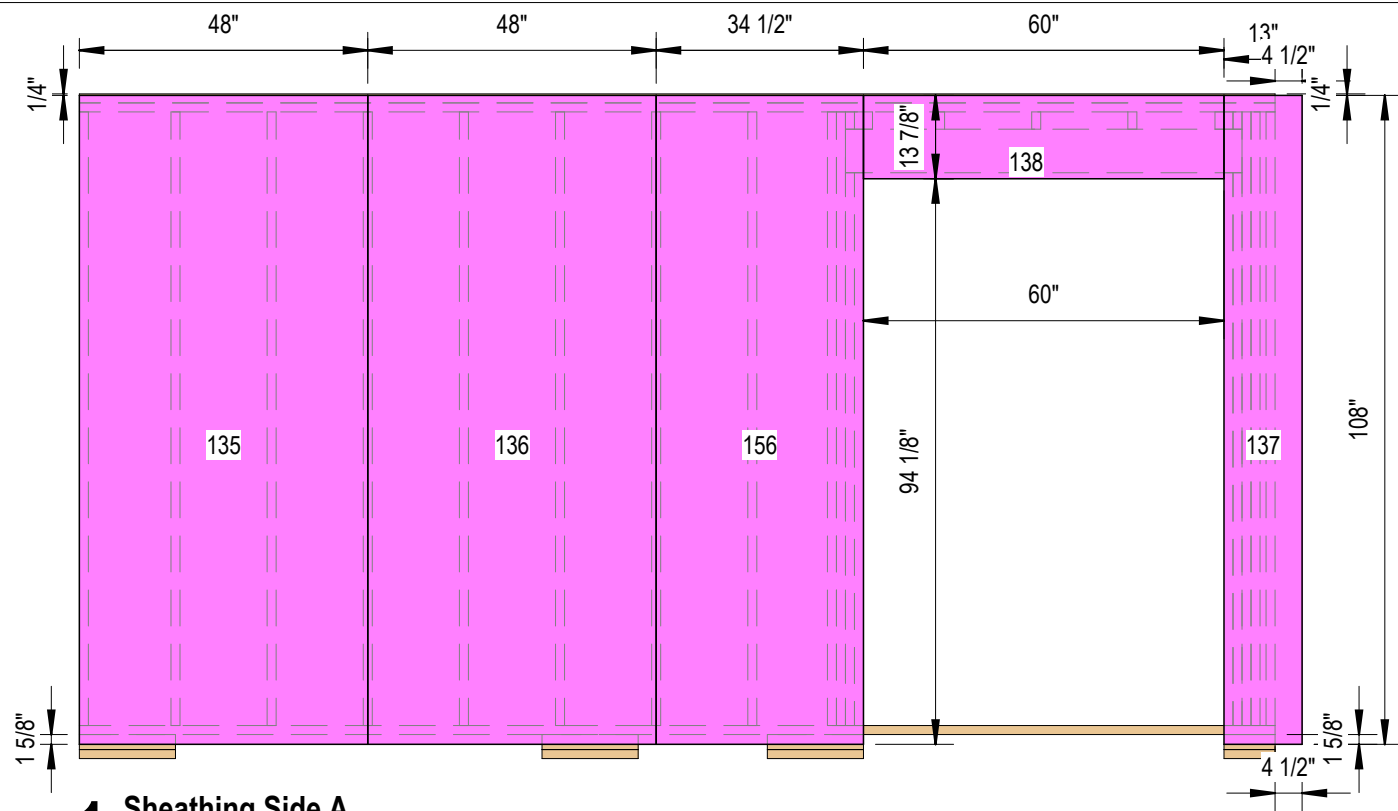

1 Sheathing Side A
3/8" = 1'-0"

Vertical Wall Sheathing Schedule				
Mark	Description	Thickness	Length	Height
135	Picasso	1"	48"	108"
136	Picasso	1"	48"	108"
137	Picasso	1"	13"	108"
138	Picasso	1"	60"	13 7/8"
151	Picasso	1"	60"	13 7/8"
156	Picasso	1"	34 1/2"	108"

Horizontal Sheathing Schedule				
Mark	Description	Thickness	Length	Width
185	Picasso	1"	60"	3 1/2"

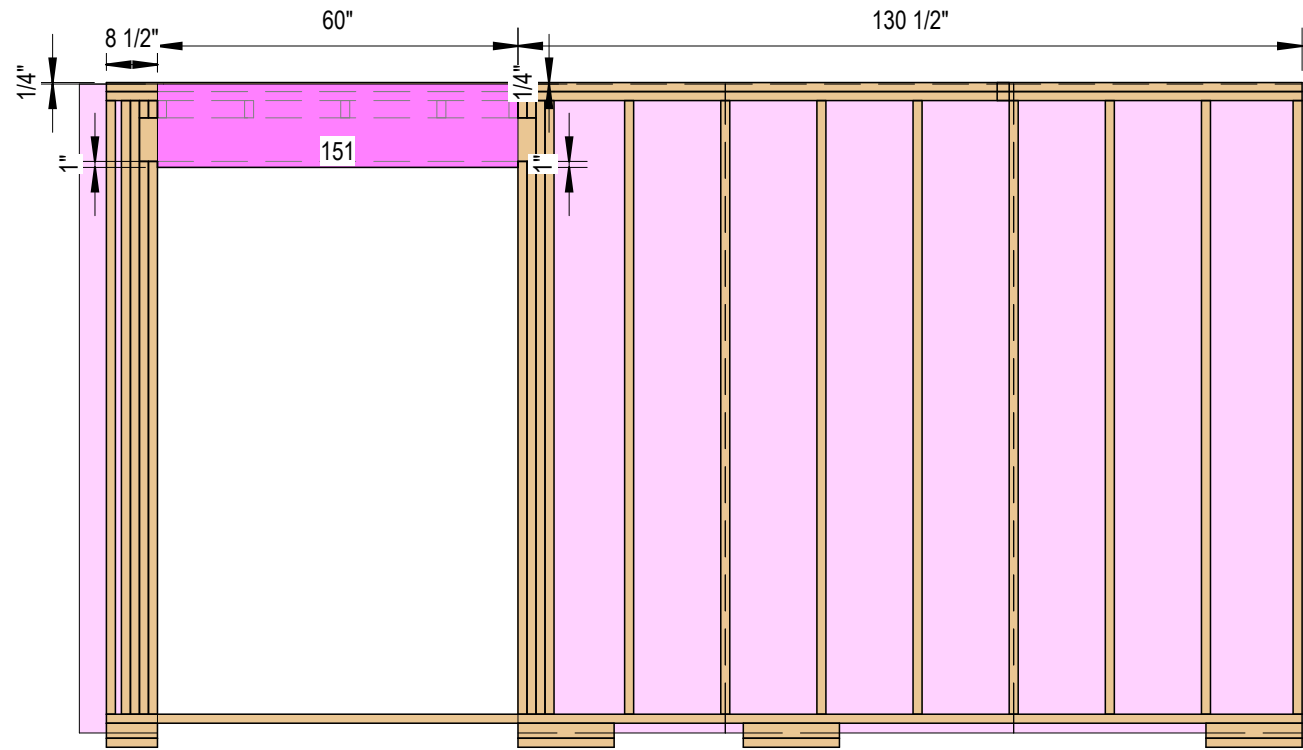

2 Sheathing Side B
3/8" = 1'-0"

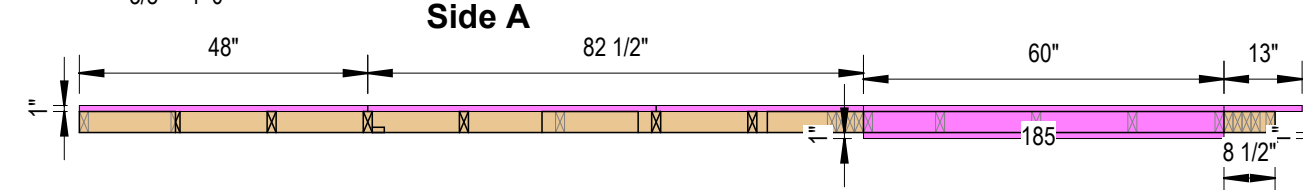

3 Sheathing Bottom View
3/8" = 1'-0"

SUMMERSTONE
1550P
LOT 60
ELEV-B-LEFT

11/7/2025 For Review				NOT FOR CONSTRUCTION

Sheathing
150.2-TEE

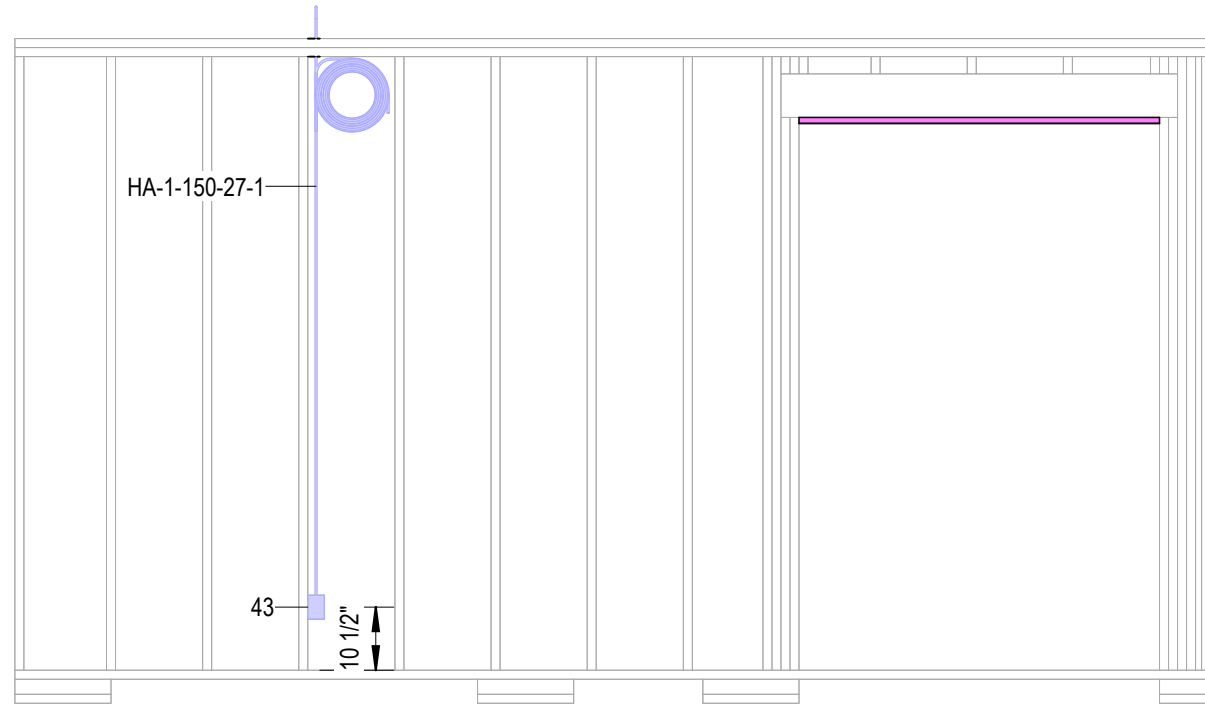

1 Electrical Side A
3/8" = 1'-0"

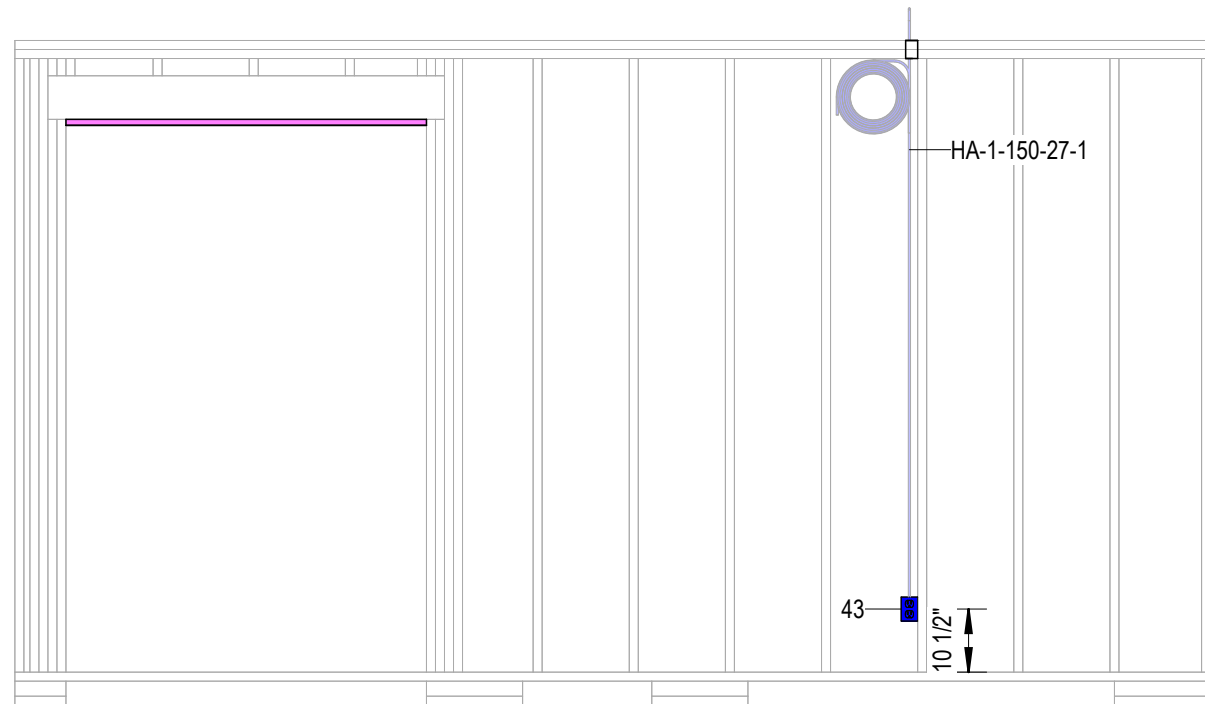

2 Electrical Side B
3/8" = 1'-0"

Electrical Fixture Schedule							
Mark	Side	Box	Device-A	Device-B	Device-C	Device-D	Comments
43	B	EZ18SNW	Receptacle: T5320W				

Protection Plate Schedule		
Count	Type	Side

Harness Assembly for TEE-150			
Prefix-Quadrant-Wall-Circuit-Whip-Index	Type	Total Length	Pull To
HA-1-150-27-1	14/2	40' - 7"	JB1-4

SUMMERSTONE
1550P
LOT 60
ELEV-B-LEFT

11/7/2025	For Review					NOT FOR CONSTRUCTION

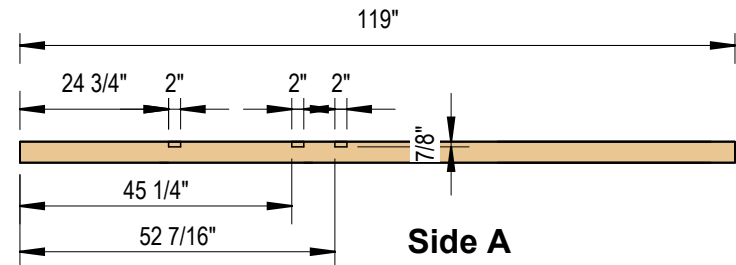

1 Top Plate
3/8" = 1'-0"

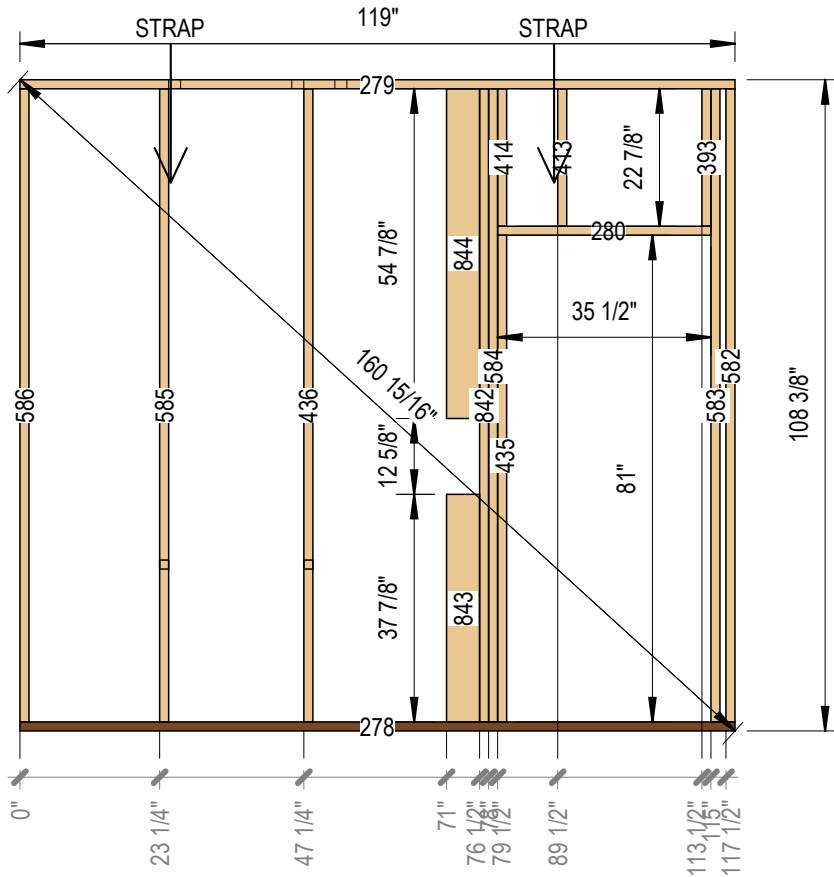

2 Framing Elevation
3/8" = 1'-0"

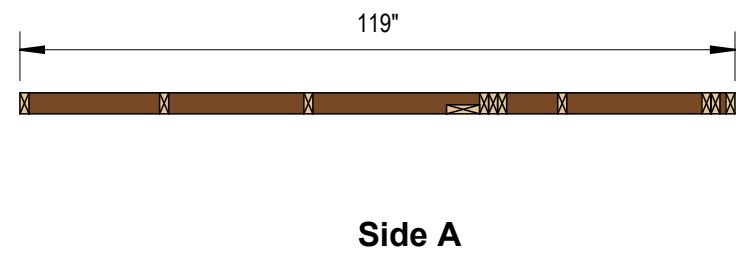

3 Bottom Plate
3/8" = 1'-0"

Structural Horizontal Framing Schedule

Mark	Piece Type	Description	Structural Material	Side	Cut Length
278	Bottom Plate	2x4	Pressure Treated SPF Standard		119"
279	Top Plate	2x4	SPF #1/#2		119"
280	Header	2x4	SPF #1/#2		35 1/2"

Structural Stud Schedule

Mark	Description	Count	Piece Type	Side	Length	Structural Material
393	2x4	1	HeaderCripple		22 7/8"	SPF #1/#2
413	2x4	1	HeaderCripple		22 7/8"	SPF #1/#2
414	2x4	1	HeaderCripple		22 7/8"	SPF #1/#2
435	2x4	1	Trimmer		81"	SPF #1/#2
436	2x4	1	Stud		105 3/8"	SPF #1/#2
582	2x4	1	Stud		105 3/8"	SPF #1/#2
583	2x4	1	Trimmer		105 3/8"	SPF #1/#2
584	2x4	1	KingStud		105 3/8"	SPF #1/#2
585	2x4	1	Stud		105 3/8"	SPF #1/#2
586	2x4	1	Stud		105 3/8"	SPF #1/#2
842	2x4	1	Stud		105 3/8"	SPF #1/#2
843 - A	2x6	1	FlatStud	A	37 7/8"	SPF #1/#2
844 - A	2x6	1	FlatStud	A	54 7/8"	SPF #1/#2

Structural Connection Schedule

Type	Count	Side

SUMMERSTONE
1550P
LOT 60
ELEV-B-LEFT

11/7/2025 For Review
NOT FOR CONSTRUCTION

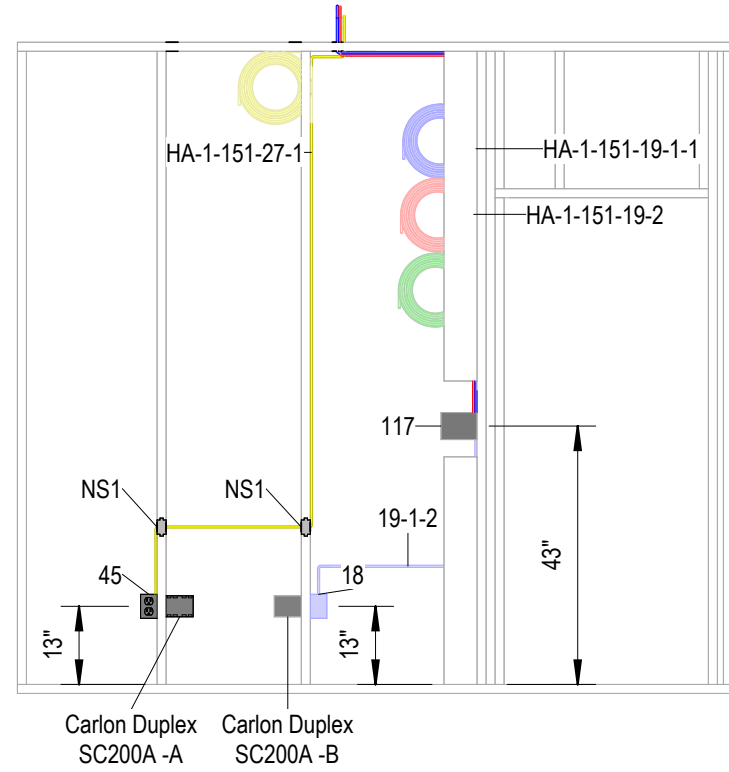

1 Electrical Side A
3/8" = 1'-0"

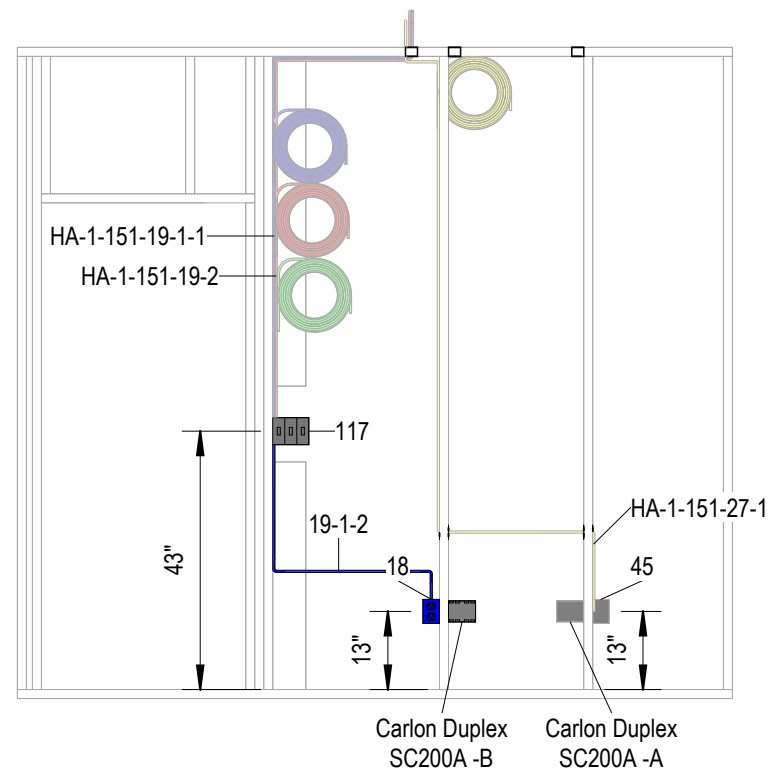

2 Electrical Side B
3/8" = 1'-0"

Electrical Fixture Schedule							
Mark	Side	Box	Device-A	Device-B	Device-C	Device-D	Comments
18	B	EZ18SNW	Receptacle: T5320W				
45	A	EZ18SNW	Receptacle: T5320W				
117	B	EZ44TN	Standard Switch: 14512W	Standard Switch: 14512W	Exhaust Fan Switch: 14512W		

Protection Plate Schedule		
Count	Type	Side
2	NS1	B

Harness Assembly for TIE-151			
Prefix-Quadrant-Wall-Circuit-Whip-Index	Type	Total Length	Pull To
HA-1-151-19-1-1	14/2	23' - 11"	JBA-1.8
HA-1-151-19-1-2	14/2	6' - 5"	
HA-1-151-19-2	14/3	20' - 10"	Light Fixture 38
HA-1-151-27-1	14/2	50' - 7"	JB1-4

SUMMERSTONE
1550P
LOT 60
ELEV-B-LEFT

11/7/2025	For Review	NOT FOR CONSTRUCTION

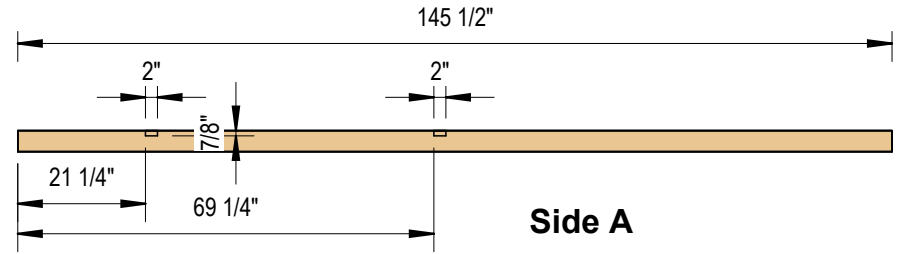

1 Top Plate
3/8" = 1'-0"

Structural Horizontal Framing Schedule

Mark	Piece Type	Description	Structural Material	Side	Cut Length
281	Bottom Plate	2x4	Pressure Treated SPF Standard		145 1/2"
282	Top Plate	2x4	SPF #1/#2		145 1/2"

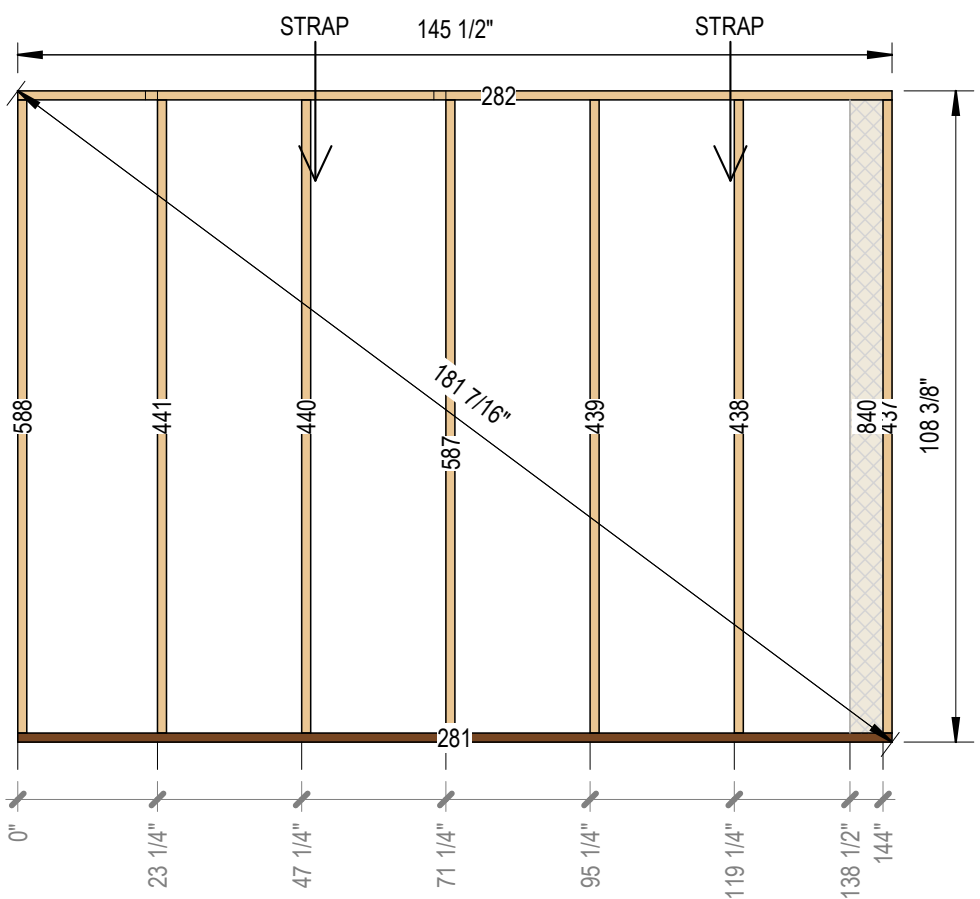

2 Framing Side A
3/8" = 1'-0"

Structural Stud Schedule

Mark	Piece Type	Description	Structural Material	Side	Length
437	Stud	2x4	SPF #1/#2		105 3/8"
438	Stud	2x4	SPF #1/#2		105 3/8"
439	Stud	2x4	SPF #1/#2		105 3/8"
440	Stud	2x4	SPF #1/#2		105 3/8"
441	Stud	2x4	SPF #1/#2		105 3/8"
587	Stud	2x4	SPF #1/#2		105 3/8"
588	Stud	2x4	SPF #1/#2		105 3/8"
840 - B	FlatStud	2x6	SPF #1/#2	B	105 3/8"

Structural Connection Schedule

Type	Count	Side

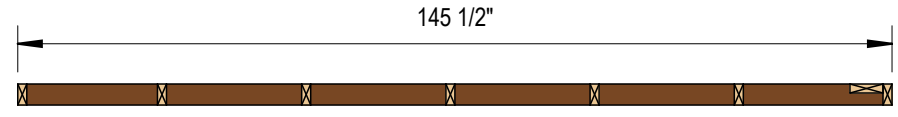

3 Bottom Plate
3/8" = 1'-0"

SUMMERSTONE
1550P
LOT 60
ELEV-B-LEFT

11/7/2025 For Review				NOT FOR CONSTRUCTION

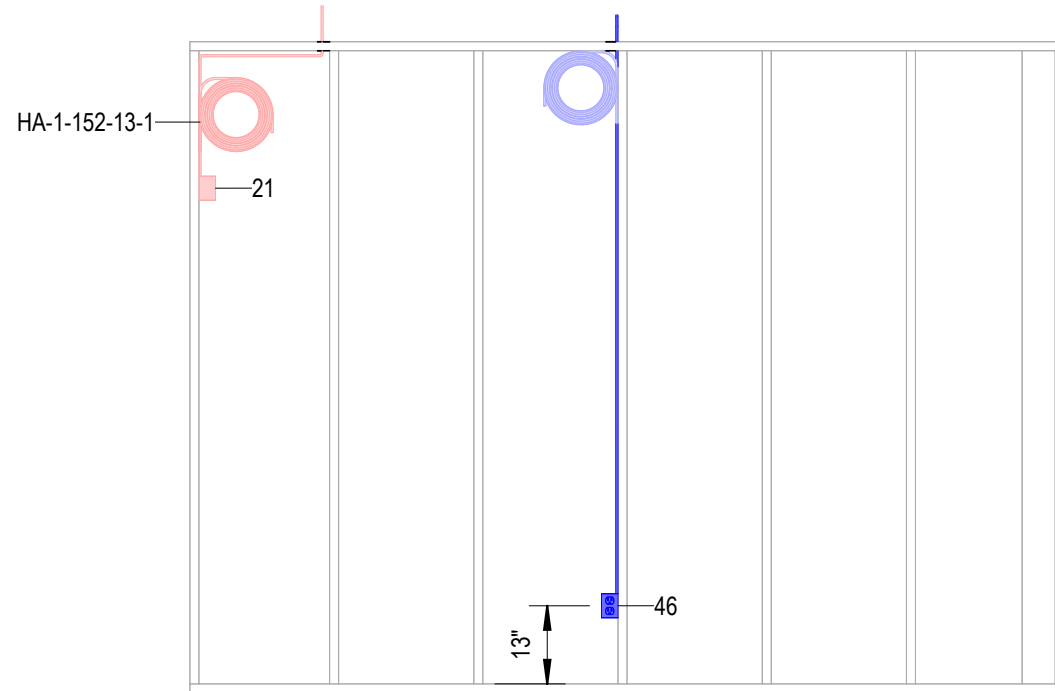

Electrical Fixture Schedule							
Mark	Side	Box	Device-A	Device-B	Device-C	Device-D	Comments
21	B	EZ18SNW	Receptacle: T5320W				Wifi Hub
46	A	EZ18SNW	Receptacle: T5320W				

Protection Plate Schedule		
Count	Type	Side

Harness Assembly for TIE-152			
Prefix-Quadrant-Wall-Circuit-Whip-Index	Type	Total Length	Pull To
HA-1-152-13-1	14/2	22' - 10"	JB1-5

SUMMERSTONE
1550P
 LOT 60
 ELEV-B-LEFT

1 Electrical Side A
 3/8" = 1'-0"

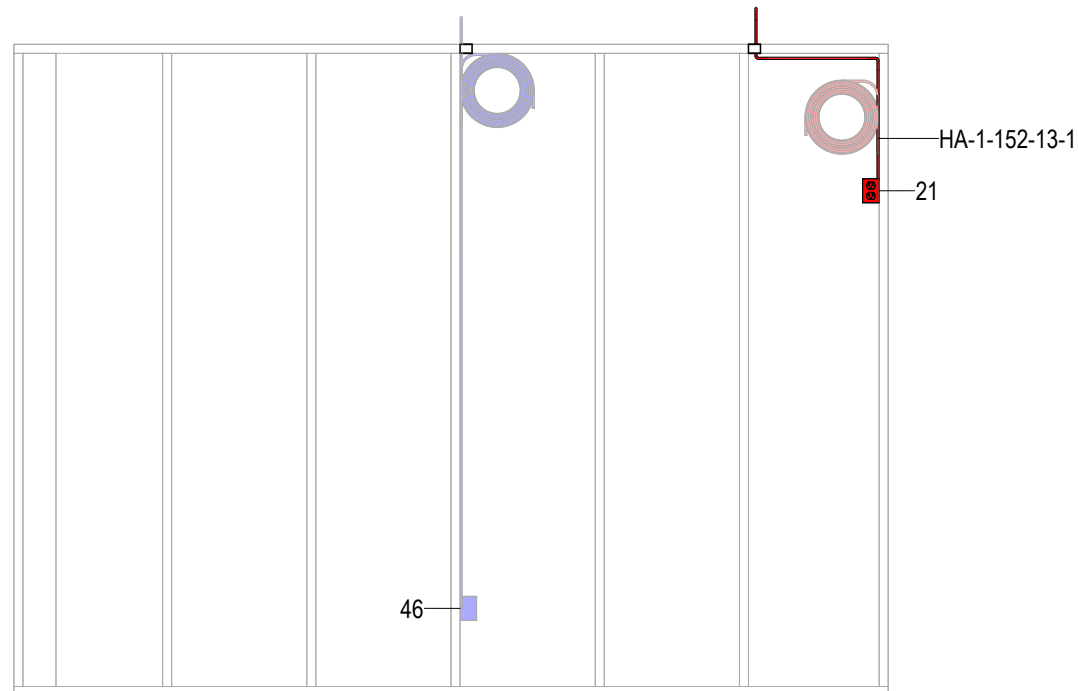

2 Electrical Side B
 3/8" = 1'-0"

11/7/2025	For Review							NOT FOR CONSTRUCTION
-----------	------------	--	--	--	--	--	--	-----------------------------

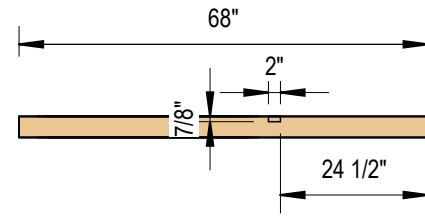

1 Top Plate
3/8" = 1'-0"

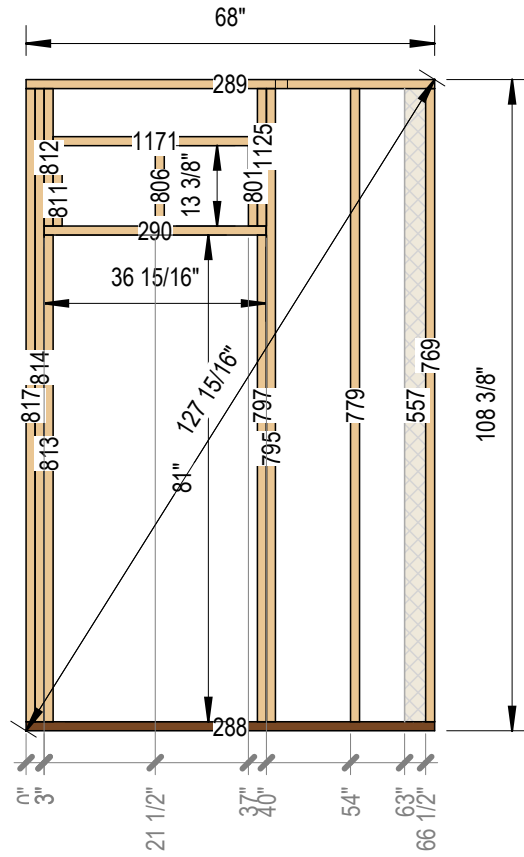

2 Framing Side A
3/8" = 1'-0"

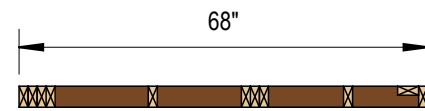

3 Bottom Plate
3/8" = 1'-0"

Side A

Structural Horizontal Framing Schedule

Mark	Piece Type	Description	Structural Material	Side	Cut Length
288	Bottom Plate	2x4	Pressure Treated SPF Standard		68"
289	Top Plate	2x4	SPF #1/#2		68"
290	Header	2x4	SPF #1/#2		36 233/256"
1171	Header	2x4	SPF #1/#2		34"

Structural Stud Schedule

Mark	Piece Type	Description	Structural Material	Side	Length
557 - B	FlatStud	2x4	SPF #1/#2	B	105 3/8"
769	Stud	2x4	SPF #1/#2		105 3/8"
779	Stud	2x4	SPF #1/#2		105 3/8"
795	KingStud	2x4	SPF #1/#2		105 3/8"
797	Trimmer	2x4	SPF #1/#2		81"
801	HeaderCripple	2x4	SPF #1/#2		13 3/8"
806	HeaderCripple	2x4	SPF #1/#2		13 3/8"
811	HeaderCripple	2x4	SPF #1/#2		13 3/8"
812	HeaderCripple	2x4	SPF #1/#2		22 7/8"
813	Trimmer	2x4	SPF #1/#2		81"
814	KingStud	2x4	SPF #1/#2		105 3/8"
817	KingStud	2x4	SPF #1/#2		105 3/8"
1125	HeaderCripple	2x4	SPF #1/#2		22 7/8"

Structural Connection Schedule

Type	Count	Side

11/7/2025	For Review	NOT FOR CONSTRUCTION
-----------	------------	-----------------------------

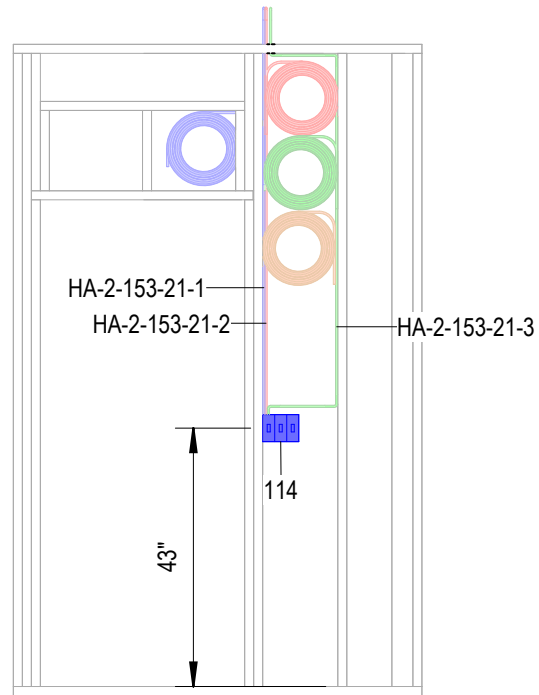

1 Electrical Side A
3/8" = 1'-0"

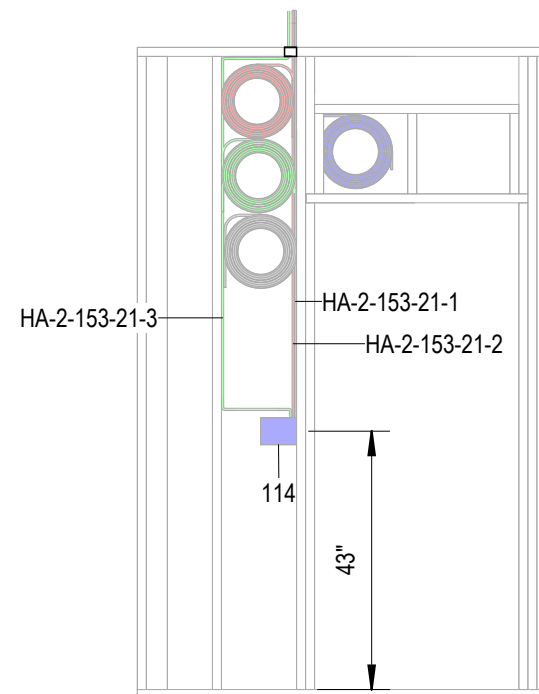

2 Electrical Side B
3/8" = 1'-0"

Electrical Fixture Schedule							
Mark	Side	Box	Device-A	Device-B	Device-C	Device-D	Comments
114	A	EZ44TN	Standard Switch: 14512W	Standard Switch: 14512W	Standard Switch: 14512W		

Protection Plate Schedule		
Count	Type	Side

Harness Assembly for TIE-153			
Prefix-Quadrant-Wall-Circuit-Whip-Index	Type	Total Length	Pull To
HA-2-153-21-1	14/2	14' - 3"	JB2-5
HA-2-153-21-2	14/3	35' - 10"	
HA-2-153-21-3	14/3	18' - 11"	Ceiling Box 7

SUMMERSTONE
1550P
LOT 60
ELEV-B-LEFT

11/7/2025	For Review							NOT FOR CONSTRUCTION
-----------	------------	--	--	--	--	--	--	-----------------------------

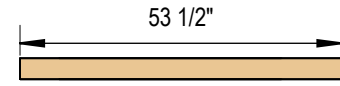

Side A

1 Top Plate
3/8" = 1'-0"

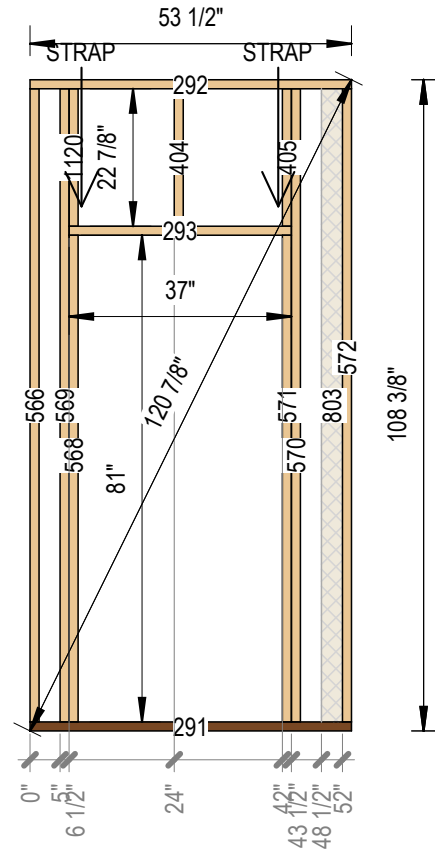

2 Framing Side A
3/8" = 1'-0"

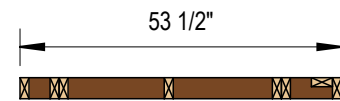

Side A

3 Bottom Plate
3/8" = 1'-0"

Structural Horizontal Framing Schedule

Mark	Piece Type	Description	Structural Material	Side	Cut Length
291	Bottom Plate	2x4	Pressure Treated SPF Standard		53 1/2"
292	Top Plate	2x4	SPF #1/#2		53 1/2"
293	Header	2x4	SPF #1/#2		37"

Structural Stud Schedule

Mark	Piece Type	Description	Structural Material	Side	Length
404	HeaderCripple	2x4	SPF #1/#2		22 7/8"
405	HeaderCripple	2x4	SPF #1/#2		22 7/8"
566	Stud	2x4	SPF #1/#2		105 3/8"
568	Trimmer	2x4	SPF #1/#2		81"
569	KingStud	2x4	SPF #1/#2		105 3/8"
570	KingStud	2x4	SPF #1/#2		105 3/8"
571	Trimmer	2x4	SPF #1/#2		81"
572	Stud	2x4	SPF #1/#2		105 3/8"
803 - B	FlatStud	2x4	SPF #1/#2	B	105 3/8"
1120	HeaderCripple	2x4	SPF #1/#2		22 7/8"

Structural Connection Schedule

Type	Count	Side
------	-------	------

11/7/2025 For Review					NOT FOR CONSTRUCTION

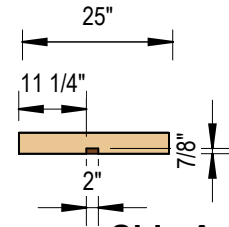

1 Top Plate
3/8" = 1'-0"

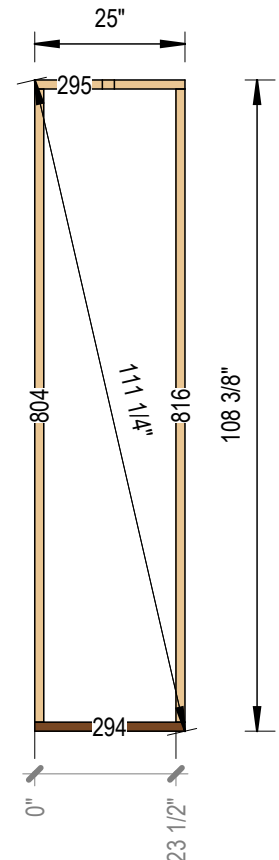

2 Framing Side A
3/8" = 1'-0"

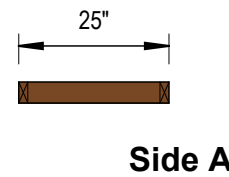

3 Bottom Plate
3/8" = 1'-0"

Structural Horizontal Framing Schedule

Mark	Piece Type	Description	Structural Material	Side	Cut Length
294	Bottom Plate	2x4	Pressure Treated SPF Standard		25"
295	Top Plate	2x4	SPF #1/#2		25"

Structural Stud Schedule

Mark	Piece Type	Description	Structural Material	Side	Length
804	Stud	2x4	SPF #1/#2		105 3/8"
816	Stud	2x4	SPF #1/#2		105 3/8"

Structural Connection Schedule

Type	Count	Side
------	-------	------



SUMMERSTONE
1550P
LOT 60
ELEV-B-LEFT

11/7/2025 For Review					NOT FOR CONSTRUCTION

Structural Framing
155.1-TIE

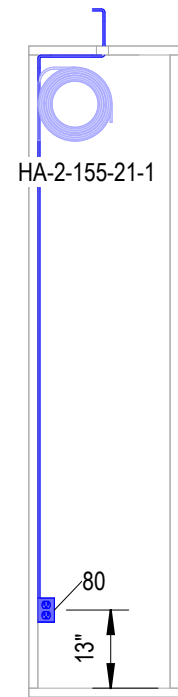

1 Electrical Side A
3/8" = 1'-0"

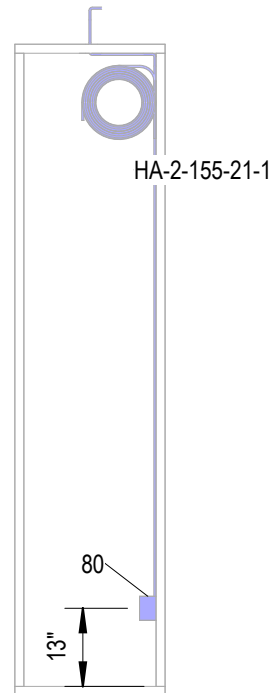

2 Electrical Side B
3/8" = 1'-0"

Electrical Fixture Schedule							
Mark	Side	Box	Device-A	Device-B	Device-C	Device-D	Comments
80	A	EZ18SNW	Receptacle: T5320W				

Protection Plate Schedule		
Count	Type	Side

Harness Assembly for TIE-155			
Prefix-Quadrant-Wall-Circuit-Whip-Index	Type	Total Length	Pull To
HA-2-155-21-1	14/2	23' - 5"	JB2-5

SUMMERSTONE
1550P
LOT 60
ELEV-B-LEFT

11/7/2025	For Review							NOT FOR CONSTRUCTION
-----------	------------	--	--	--	--	--	--	-----------------------------

1 Top Plate
3/8" = 1'-0"

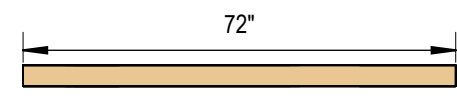

Side A

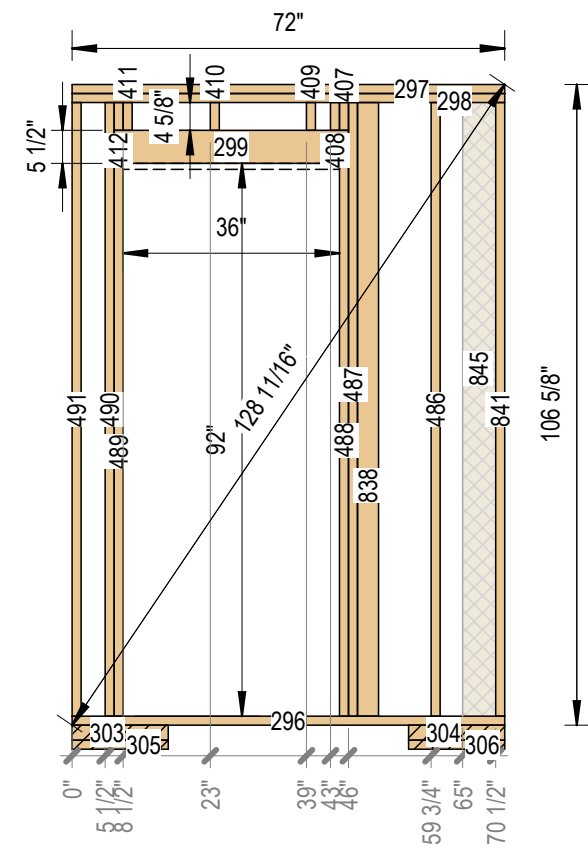

2 Framing Side A
3/8" = 1'-0"

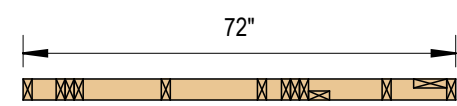

Side A

3 Bottom Plate
3/8" = 1'-0"

Structural Horizontal Framing Schedule

Mark	Piece Type	Description	Structural Material	Side	Cut Length
296	Bottom Plate	2x4	SPF #1/#2		72"
297	Top Plate	2x4	SPF #1/#2		72"
298	Top Plate	2x4	SPF #1/#2		72"
299	Header	4x6	DF #2		39"
303	Temporary	3x4	SPF Standard		16"
304	Temporary	3x4	SPF Standard		16"
305	Temporary	2x4	SPF Standard		16"
306	Temporary	2x4	SPF Standard		16"

Structural Stud Schedule

Mark	Piece Type	Description	Structural Material	Side	Length
407	HeaderCripple	2x4	SPF #1/#2		4 5/8"
408	HeaderCripple	2x4	SPF #1/#2		4 5/8"
409	HeaderCripple	2x4	SPF #1/#2		4 5/8"
410	HeaderCripple	2x4	SPF #1/#2		4 5/8"
411	HeaderCripple	2x4	SPF #1/#2		4 5/8"
412	HeaderCripple	2x4	SPF #1/#2		4 5/8"
486	Stud	2x4	SPF #1/#2		102 1/8"
487	KingStud	2x4	SPF #1/#2		102 1/8"
488	Trimmer	2x4	SPF #1/#2		92"
489	Trimmer	2x4	SPF #1/#2		92"
490	KingStud	2x4	SPF #1/#2		102 1/8"
491	Stud	2x4	SPF #1/#2		102 1/8"
838 - A	FlatStud	2x4	SPF #1/#2	A	102 1/8"
841	Stud	2x4	SPF #1/#2		102 1/8"
845 - B	FlatStud	2x6	SPF #1/#2	B	102 1/8"

Structural Connection Schedule

Type	Count	Side
------	-------	------

SUMMERSTONE
1550P
LOT 60
ELEV-B-LEFT

11/7/2025 For Review					NOT FOR CONSTRUCTION

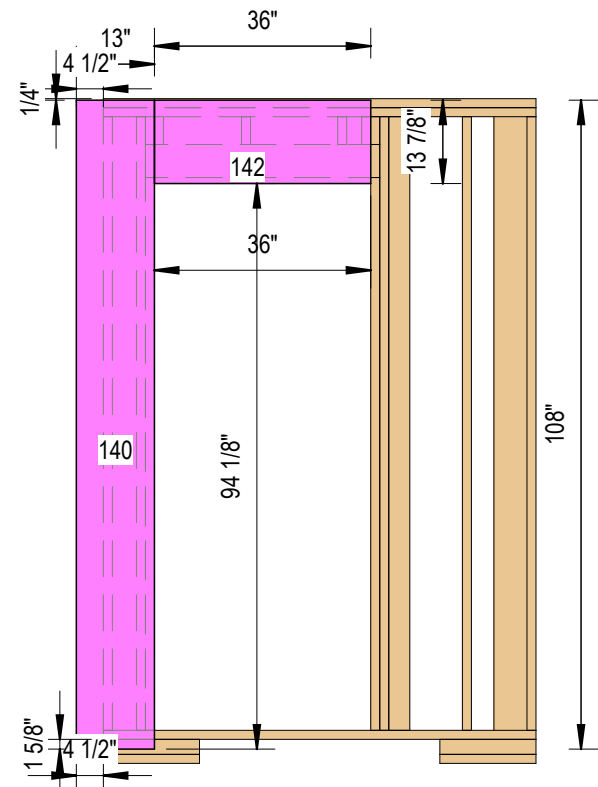

1 Sheathing Side A

3/8" = 1'-0"
23"

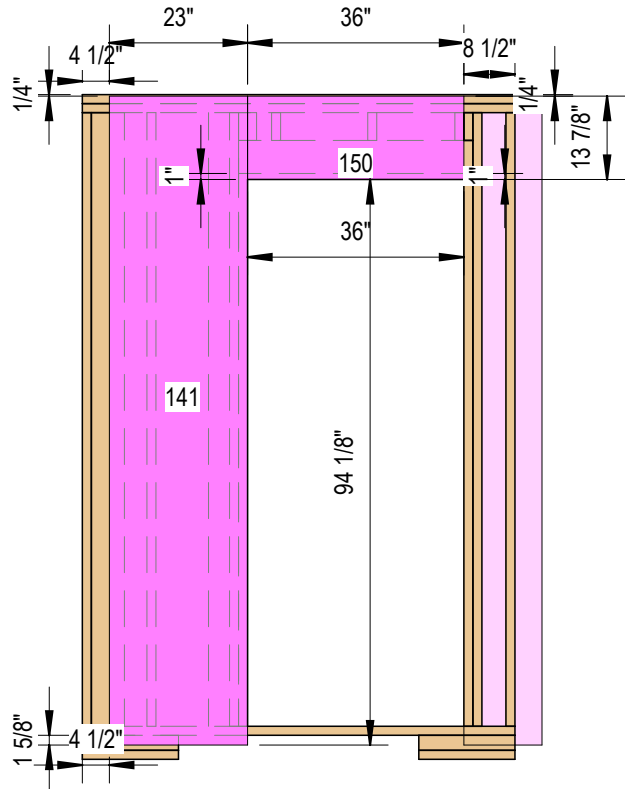

2 Sheathing Side B

3/8" = 1'-0"

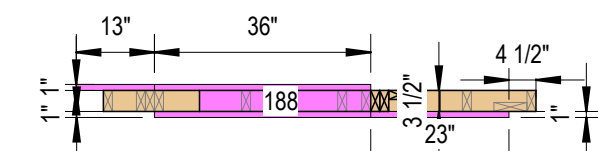

3 Sheathing Bottom View

3/8" = 1'-0"

Vertical Wall Sheathing Schedule

Mark	Description	Thickness	Length	Height
140	Picasso	1"	13"	108"
141	Picasso	1"	23"	108"
142	Picasso	1"	36"	13 7/8"
150	Picasso	1"	36"	13 7/8"

Horizontal Sheathing Schedule

Mark	Description	Thickness	Length	Width
188	Picasso	1"	36"	3 1/2"



SUMMERSTONE
1550P
LOT 60
ELEV-B-LEFT

11/7/2025	For Review					NOT FOR CONSTRUCTION

Sheathing
156.2-TES

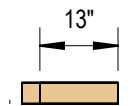

Side A

1 Top Plate
3/8" = 1'-0"

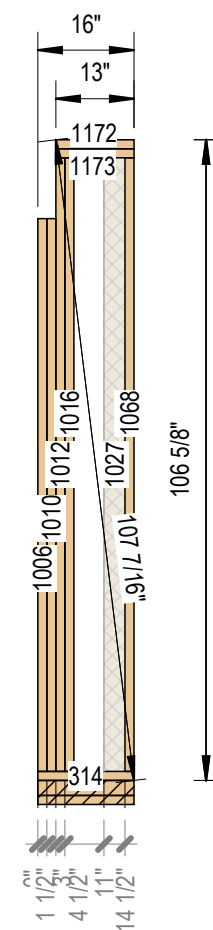

2 Framing Side A
3/8" = 1'-0"

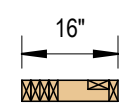

Side A

3 Bottom Plate
3/8" = 1'-0"

Structural Horizontal Framing Schedule

Mark	Piece Type	Description	Structural Material	Side	Cut Length
314	Bottom Plate	2x4	SPF #1/#2		16"
315	Temporary	3x4	SPF Standard		16"
316	Temporary	2x4	SPF Standard		16"
1172	Top Plate	2x4	SPF #1/#2		13"
1173	Top Plate	2x4	SPF #1/#2		13"

Structural Stud Schedule

Mark	Piece Type	Description	Structural Material	Side	Length
1006	Stud	2x4	SPF #1/#2		92"
1010	Stud	2x4	SPF #1/#2		92"
1012	Stud	2x4	SPF #1/#2		102 1/8"
1016	Stud	2x4	SPF #1/#2		102 1/8"
1027 - B	FlatStud	2x4	SPF #1/#2	B	102 1/8"
1068	Stud	2x4	SPF #1/#2		102 1/8"

Structural Connection Schedule

Type	Count	Side



SUMMERSTONE
1550P
LOT 60
ELEV-B-LEFT

11/7/2025 For Review					NOT FOR CONSTRUCTION

Vertical Wall Sheathing Schedule

Mark	Description	Thickne ss	Length	Height
146	Picasso	1"	16"	108"

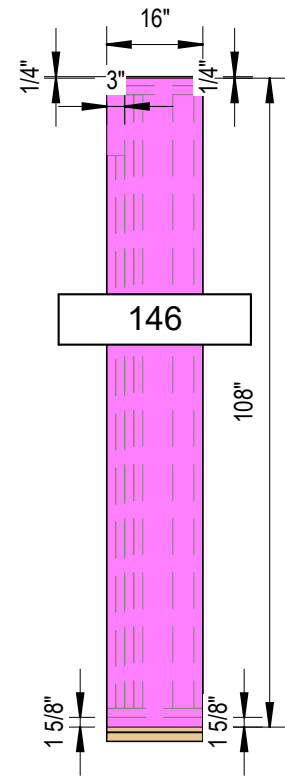

146

1 Sheathing Side A
3/8" = 1'-0"

SUMMERSTONE
1550P
LOT 60
ELEV-B-LEFT

11/7/2025	For Review									NOT FOR CONSTRUCTION

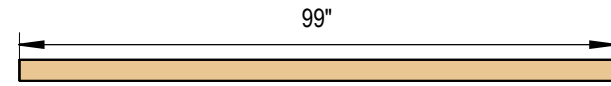

Side A

1 Top Plate
3/8" = 1'-0"

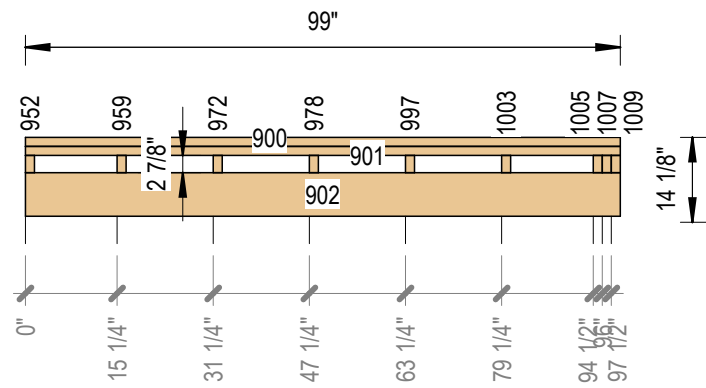

2 Framing Side A
3/8" = 1'-0"

Structural Horizontal Framing Schedule

Mark	Piece Type	Description	Structural Material	Side	Cut Length
900	Top Plate	2x4	SPF #1/#2		99"
901	Top Plate	2x4	SPF #1/#2		99"
902	Top Plate	4x8	DF #2		99"

Structural Stud Schedule

Mark	Piece Type	Description	Structural Material	Side	Length
952	Stud	2x4	SPF #1/#2		2 7/8"
959	Stud	2x4	SPF #1/#2		2 7/8"
972	Stud	2x4	SPF #1/#2		2 7/8"
978	Stud	2x4	SPF #1/#2		2 7/8"
997	Stud	2x4	SPF #1/#2		2 7/8"
1003	Stud	2x4	SPF #1/#2		2 7/8"
1005	Stud	2x4	SPF #1/#2		2 7/8"
1007	Stud	2x4	SPF #1/#2		2 7/8"
1009	Stud	2x4	SPF #1/#2		2 7/8"

Structural Connection Schedule

Type	Count	Side

SUMMERSTONE
1550P
LOT 60
ELEV-B-LEFT

11/7/2025	For Review	NOT FOR CONSTRUCTION

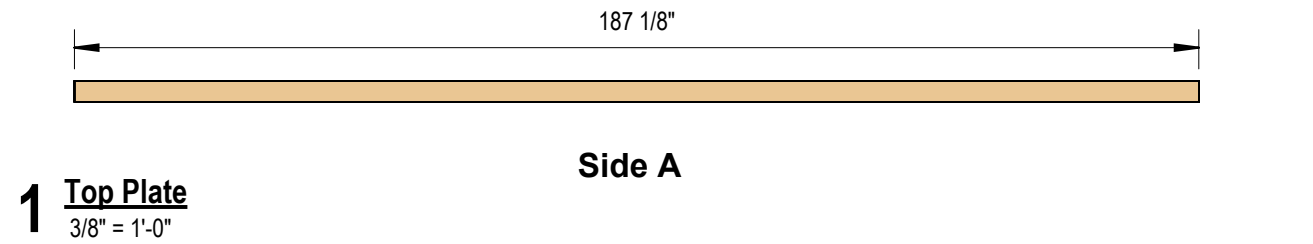

Structural Horizontal Framing Schedule					
Mark	Piece Type	Description	Structural Material	Side	Cut Length
191	Bottom Plate	2x4	SPF #1/#2		187 1/8"
192	Top Plate	2x4	SPF #1/#2		187 1/8"
193	Top Plate	2x4	SPF #1/#2		187 1/8"
194	Temporary	3x4	SPF Standard		16"
195	Temporary	3x4	SPF Standard		16"
196	Temporary	3x4	SPF Standard		16"
197	Temporary	2x4	SPF Standard		16"
198	Temporary	2x4	SPF Standard		16"
199	Temporary	2x4	SPF Standard		16"
1162	Temporary	3x4	SPF Standard		16"
1163	Temporary	2x4	SPF Standard		16"

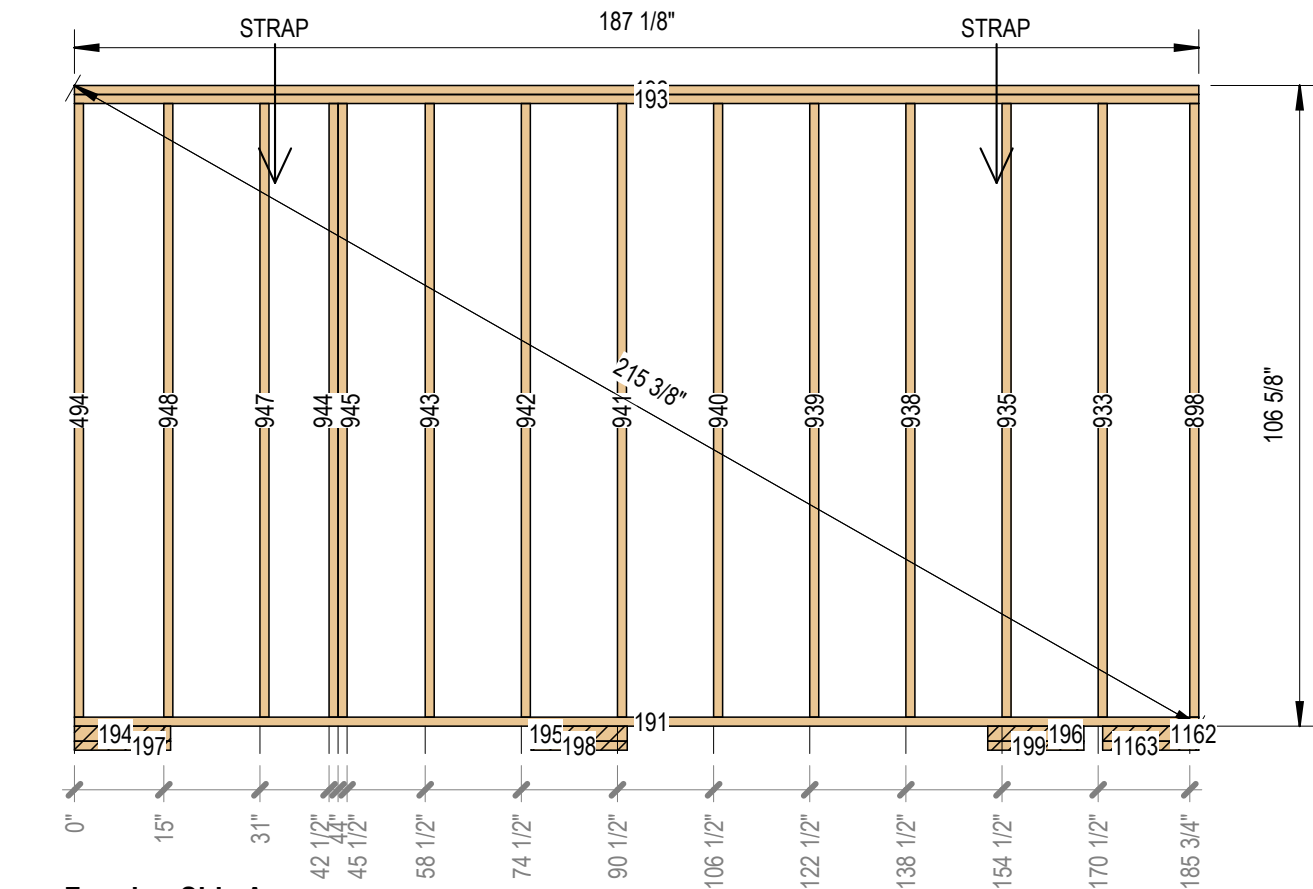

Structural Stud Schedule					
Mark	Piece Type	Description	Structural Material	Side	Length
494	Stud	2x4	SPF #1/#2		102 1/8"
898	Stud	2x4	SPF #1/#2		102 1/8"
933	Stud	2x4	SPF #1/#2		102 1/8"
935	Stud	2x4	SPF #1/#2		102 1/8"
938	Stud	2x4	SPF #1/#2		102 1/8"
939	Stud	2x4	SPF #1/#2		102 1/8"
940	Stud	2x4	SPF #1/#2		102 1/8"
941	Stud	2x4	SPF #1/#2		102 1/8"
942	Stud	2x4	SPF #1/#2		102 1/8"
943	Stud	2x4	SPF #1/#2		102 1/8"
944	Stud	2x4	SPF #1/#2		102 1/8"
945	Stud	2x4	SPF #1/#2		102 1/8"
947	Stud	2x4	SPF #1/#2		102 1/8"
948	Stud	2x4	SPF #1/#2		102 1/8"

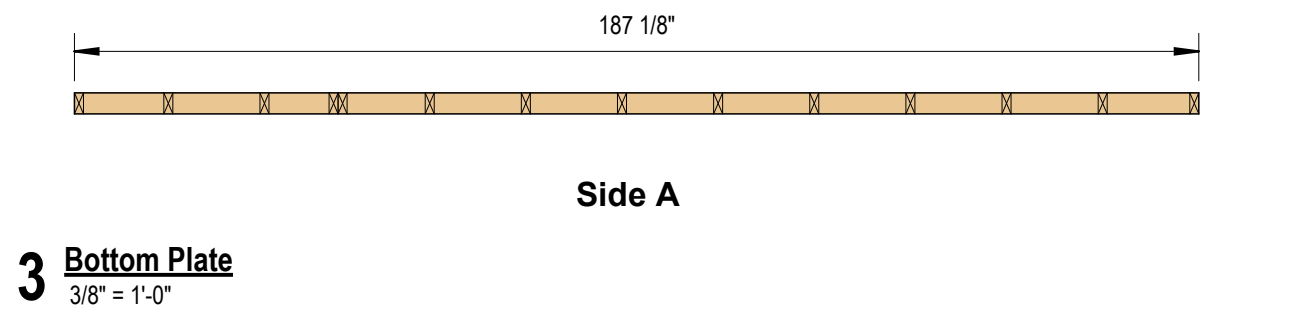

Structural Connection Schedule		
Type	Count	Side

SUMMERSTONE
1550P
LOT 60
ELEV-B-LEFT

11/7/2025 For Review				NOT FOR CONSTRUCTION

Vertical Wall Sheathing Schedule				
Mark	Description	Thickness	Length	Height
103	Picasso	1"	48"	108"
104	Picasso	1"	48"	108"
105	Picasso	1"	48"	108"
147	Picasso	1"	48"	108"

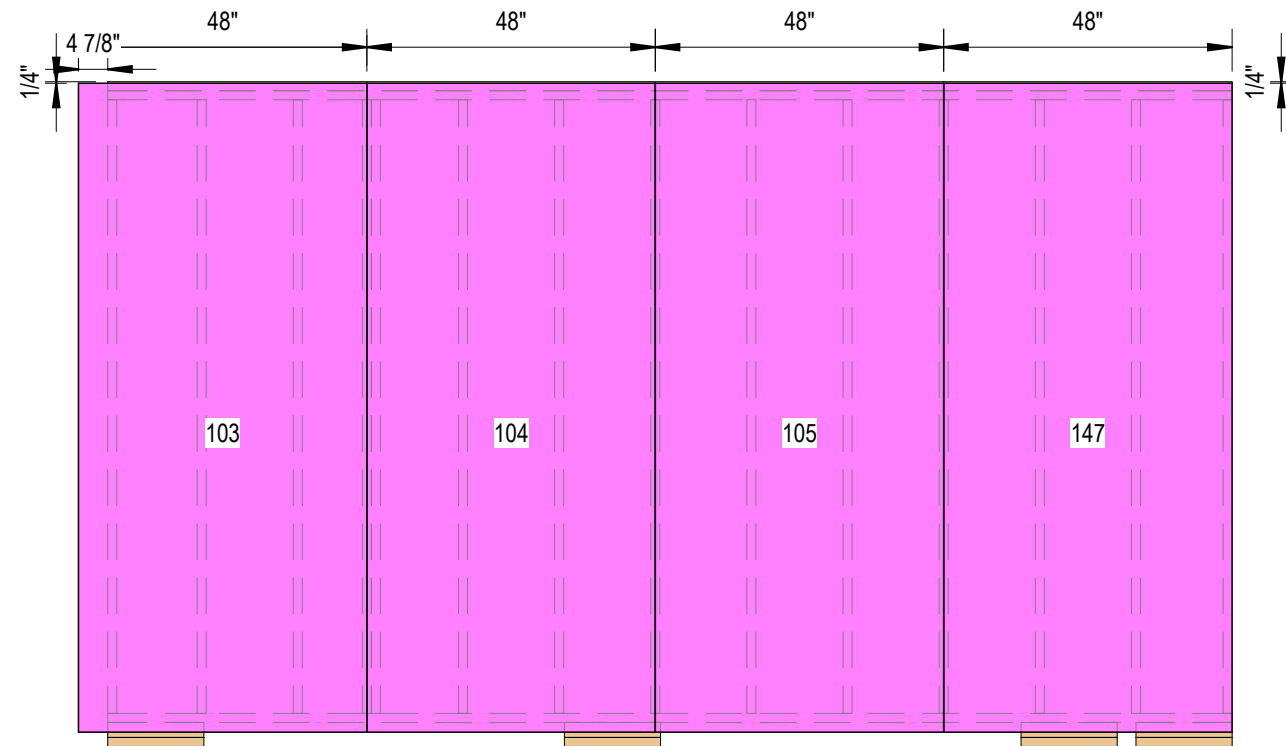

1 Sheathing Side A
3/8" = 1'-0"

SUMMERSTONE
1550P
LOT 60
ELEV-B-LEFT

11/7/2025	For Review					NOT FOR CONSTRUCTION

Vertical Wall Sheathing Schedule				
Mark	Description	Thickness	Length	Height
144	Picasso	1"	48"	108"
145	Picasso	1"	48"	108"

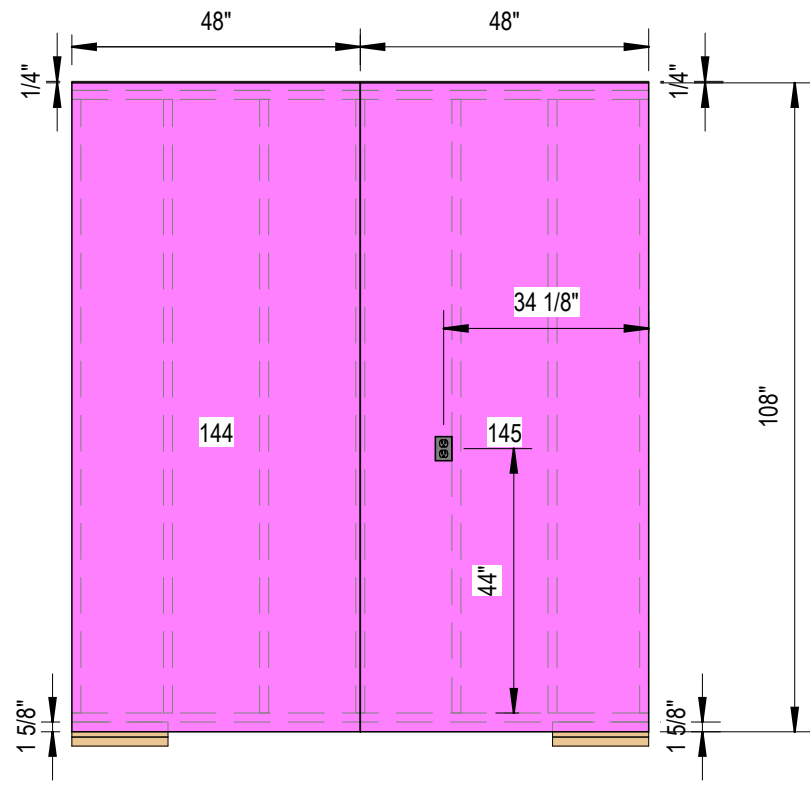

1 Sheathing Side A
3/8" = 1'-0"

SUMMERSTONE
1550P
LOT 60
ELEV-B-LEFT

11/7/2025	For Review					NOT FOR CONSTRUCTION

